



BARRET®

ATTREZZATURE PER L'ALLENAMENTO DEI CAMPIONI
TRAINING TOOLS FOR CHAMPIONS

catalogo
2021-2022
brochure



GET READY FOR THE MATCH!

INDICE ALFABETICO

| | |
|---|--------------------------|
| Archi di precisione - Precision Arcs | pag. 39 |
| Arredi spogliatoio ed infermeria - Locker and infirmary room | pag. 156-161 |
| Arti Marziali, Boxe - Martial Arts, Boxing | pag. 202-203;205; 209 |
| Atletica - Track and Field | pag. 215-218 |
| Attrezzi speciali, Scalette e Bande elastiche - Special Training tools, Speed Ladders and Elastic Bands | pag. 63-79 |
| Badminton..... | pag. 200 |
| Bandierine e accessori per arbitro - Flags and referee's accessories..... | pag. 108-111 |
| Barriera filtrante, Barriera con finestre - Reflex Training Device, Window Barrier..... | pag. 42 |
| Basket | pag. 165-172 |
| Beach Soccer | pag. 163 |
| Beach Volley | pag. 180-181 |
| Borse - Bags..... | pag. 124-125 |
| Casacche, Pantaloncini, Calze, Giacche Antipioggia, Tubolare Barret | pag. 89-91 |
| Ceste Portapalloni - Baskets for balls | pag. 126 |
| Cross Training, Reti con bersagli - Cross Training, Nets with targets..... | pag. 141-142 |
| Delimitatori e Birilli - Markers and Cones | pag. 21-25 |
| Deviatori di traiettoria, Ball Playning - Deviators, Ball Playning | pag. 52-54 |
| Fitness Equipment..... | pag. 81-88 |
| Forche - Heading Trellises..... | pag. 40-41 |
| Ghiaccio, Tape, Creme, Oli - Ice, Tape, Creams, Oils..... | pag. 104-105 |
| Ginnastica - Gymnastic | pag. 210-214 |
| Hockey, Baseball | pag. 201;204 |
| Impianti Multifunzione - Multi purpose systems | pag. 184 |
| Kit Calcio Tennis - Soccer Tennis kits..... | pag. 36-38 |
| Kit tecnico Scuola Calcio - Soccer School kit..... | pag. 80 |
| Lavagne Tattiche - Tactical Boards..... | pag. 100-103 |
| Materassi, Protezioni Murarie - Mats, Wall Protections..... | pag. 206-208 |
| Materassini, Borracce - Mats, Water Bottles | pag. 99;106-107 |
| Minivolley, Superminivolley | pag. 179 |
| Muri e Telai con rete - Rebounders and Iron Frames with net | pag. 43-51 |
| Numeri Termosaldabili | pag. 98 |
| Ostacoli ad altezza fissa e regolabile - Hurdles fixed and adjustable heights..... | pag. 26-35 |
| Paletti Slalom - Slalom Poles..... | pag. 18-20 |
| Pallamano - Handball | pag. 185 |
| Palle Mediche, Ritmiche e Psicomotorie - Medicine, Rhythmic and Gym Balls..... | pag. 120-123 |
| Palloni in pelle ed in gomma - Leather and rubber Balls | pag. 116-119 |
| Panchine Allenatori - Trainers' Dug-outs..... | pag. 143-149 |
| Parastinchi, Fasce Capitano, Guanti Portiere - Shinguards, Captain Armbands, GK Gloves | pag. 96-97 |
| Pilates, Didattica Scolastica, Pattini e Skateboard - Pilates, School Products, Skates | pag. 219-222 |
| Piscina, Pallanuoto - Swimming Pool, Waterpolo | pag. 197-199 |
| Pompe, Compressore, Cronometri e Rotelle Metriche - Pumps, Inflator, Chronometers, Measuring Tapes | pag. 114-115 |
| Porte regolamentari, ridotte, miniporte, porte bifrontali - Official goals, reduced goals, minigoals, 2 side goals..... | pag. 127-136 |
| Protezioni personali - Protections | pag. 182-183 |
| Reti di Protezione - Protection Nets..... | pag. 140 |
| Reti regolamentari e ridotte - Nets all sizes..... | pag. 137-139 |
| Rugby..... | pag. 195-196 |
| Sagome e Barriere - Mannequins and Barriers..... | pag. 6-17 |
| Sedute per gradinate e Tribune modulari per interno ed esterno - Stadium seats and Stands | pag. 153-155 |
| Segnalatori manuali ed elettronici per cambio giocatori - Substitution Boards | pag. 112-113 |
| Strutture instabili e Tavole Propriocettive, Plinti - Equilibrium Boards..... | pag. 55-61 |
| Tabelloni elettronici segnapunti - Electronic scoreboards..... | pag. 186-188 |
| Tacchetti ed accessori per scarpe, Lavascarpe - Studs and shoe accessories, Shoe Washing Device..... | pag. 92-95 |
| Tavoli calcetto - Soccer tables | pag. 164 |
| Tennis Tavolo - Table Tennis | pag. 192-194 |
| Tennis, Beach Tennis, Padel | pag. 189-191 |
| Trampolini - Trampolines | pag. 62 |
| Tunnel uscita spogliatoi - Stadium Tunnels..... | pag. 162 |
| Vernice Segnacampo, Carrelli Traccialinee - Ecological Paint, Line Markers..... | pag. 150-152 |
| Volley | pag. 173-178 |



Allenamento 28/09/2018 - Training session 24/09/2018



Allenamento 12/03/2019 - Training session 12/03/2019



Allenamento 12/03/2019 - Training session 12/03/2019



Barret Srl

Dal 1989 Barret Srl produce attrezzature tecniche per lo sport.

In particolare, l'Azienda si è affermata nel corso degli anni per la ideazione e realizzazione di strumenti di allenamento ormai divenuti indispensabili per la preparazione fisica, tecnica e tattica dei giocatori di Calcio, così come per la preparazione degli atleti di molti altri sport, sia di squadra che individuali.

Barret offre la più ampia varietà di attrezzature quali ad esempio sagome, ostacoli, delimitatori, birilli, paletti per slalom, archi di precisione, kit per Calcio-Tennis, forche, bande elastiche, slitte, plinti, tavolette propriocettive, telai con rete, muri in vetroresina, miniporte, porte bifrontali, ridotte e regolamentari.

La qualità che distingue i prodotti offerti e le numerose innovazioni proposte con continuità nel corso degli anni hanno permesso all'Azienda di affermarsi non solo sul mercato italiano, ma anche su quello internazionale.

Barret ha sviluppato nel tempo una preziosa collaborazione con Milan ed Inter, fondamentale per permettere un interscambio di idee ed informazioni con i preparatori atletici della prima squadra e del settore giovanile, finalizzato al continuo miglioramento della funzionalità delle attrezzature tecniche per l'allenamento.

I prodotti Barret, infatti, vengono utilizzati quotidianamente sui campi di allenamento di Milanello e di Appiano Gentile per coadiuvare la preparazione fisica e tecnica di alcuni tra i migliori giocatori di Calcio del mondo.

Sarebbe impresa ardua ricordare tutti i Club nazionali ed internazionali e le Nazionali che hanno scelto più volte di acquistare le nostre attrezzature attraverso la rete distributiva italiana ed estera.

Cogliamo l'occasione per ringraziare i preparatori atletici ed i responsabili acquisti di Milan, Inter, Juventus, Roma, Lazio, Napoli, Sampdoria, Fiorentina, Palermo, Torino, Empoli, Cagliari, Bologna, Sassuolo, Spal, Barcellona, Real Madrid, Bayern Monaco, Arsenal, Chelsea, Manchester City, Zenit e delle Nazionali di Calcio di Italia, Germania, Inghilterra, Francia, Spagna e Russia

Company Profile

Founded in 1989, Barret Srl gained a foothold in the international football training equipment market by creating innovative tools which have become more and more essential during training sessions of pro athletes worldwide

Barret manufactures products such as mannequins, hurdles, markers, cones, slalom poles, shooting arcs, soccer-tennis kits, heading trellises, all kinds of fiberglass and net rebounders, sledges, vaulting boxes, equilibrium boards, any size goals and mini goals.

The quality and variety of products introduced over the years make Barret the go to company when training camp is about to start.

Barret has a long history of working together with AC Milan and FC Internazionale Milano, two of the most prestigious Clubs in football history : all the inputs and feedbacks received by their coaches always pushes Barret to shape and improve new products

As a matter of fact Barret tools are used everyday at Appiano Gentile and Milanello Training Centers in order to constantly enhance AC Milan and FC Internazionale players' athletic and technical performances.

It would be nearly impossible to name all professional Football Clubs and National Teams that have chosen to purchase Barret products through our distribution network.

However we would like to take this opportunity to thank Clubs such as Milan, Inter, Juventus, Roma, Lazio, Napoli, Sampdoria, Fiorentina, Palermo, Torino, Empoli, Cagliari, Bologna, Sassuolo, Spal, Barcellona, Real Madrid, Bayern Monaco, Arsenal, Chelsea, Manchester City, Zenit and the Italian, English, German, Spanish, French and Russian National Teams.

BARRET®

Le materie prime (i vari preparati plastici ed i profilati in polipropilene copolimero ed in PVC nei vari diametri, spessori e colori) utilizzate da BARRET per lo stampaggio e l'assemblaggio degli articoli in materiale plastico sono certificate dai nostri fornitori nel rispetto delle normative vigenti che impediscono l'utilizzo di sostanze ritenute tossiche per la salute dell'uomo e dell'ambiente.

Barret manufactures plastic products in PVC and polypropylene such as dummies, cones, markers, hurdles, slalom poles etc. using only certified non toxic raw materials not dangerous for human beings and the environment.

NUOVI PRODOTTI - NEW PRODUCTS



Art. 239TI

Ostacolo con traversa inclinata altezza variabile da cm. 12 a cm. 60 in ferro verniciato - larghezza mt. 2 (scomponibile) **Ordinare quantità multipla di 3 pezzi**

Hurdle with inclined crossbar height from 12 cm. to 60 cm. in painted iron - width 2 meters (dismountable in 3 pieces) **Please order multiple quantities of 3 pieces**



Pag. 133

Art. 500SG

Porta m. 3x2 trasportabile in ferro verniciato, tubo sezione mm. 50 completa di rete, ganci e picchetti

3x2 meter transportable Goal in painted iron, pipe section 50 mm. complete with net and anchor pegs



Pag. 136

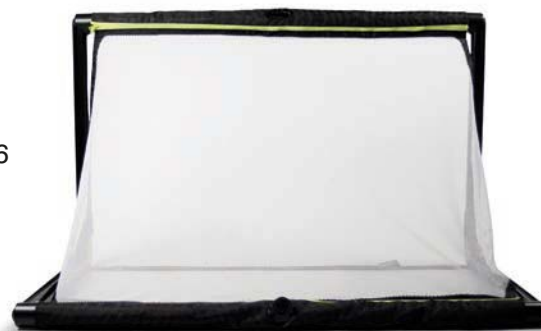

Art. BG150

Miniporta cm.150x90 pieghevole in PVC con rete personalizzabile (si installa in 10 secondi e si trasporta facilmente)

Foldable 150x90 cm. mini-goal in PVC with customizable net (ready in 10 seconds and very easy to transport)



Art. SKN05 / SKN1 / SKN2 / SKN3 / SKN4 / SKN5

Palle mediche SKIN BALL riempite con acqua demineralizzata colorata - peso kg. 0,5-1-2-3-4-5
 SKIN BALL Medicine balls filled with demineralized coloured water - weight 0,5-1-2-3-4-5 Kg.



Art. BOS

Pedana BOSU Ø cm.59 - h. cm.26
ideale per fitness, yoga, pilates
completa di elastici con maniglie e pompa
 Bosu ball Ø 59 cm. - h. 26 cm.
 ideal for fitness, yoga, pilates
 complete with rubber bands with handles and pump



Art. MGED6 / MGED8 / MGED10

Manubrio esagonale con rivestimento in gomma Kg. 6-8-10
(fornito singolarmente)
 Hexagonal Dumb Bell with rubber coating 6-8-10 Kg.

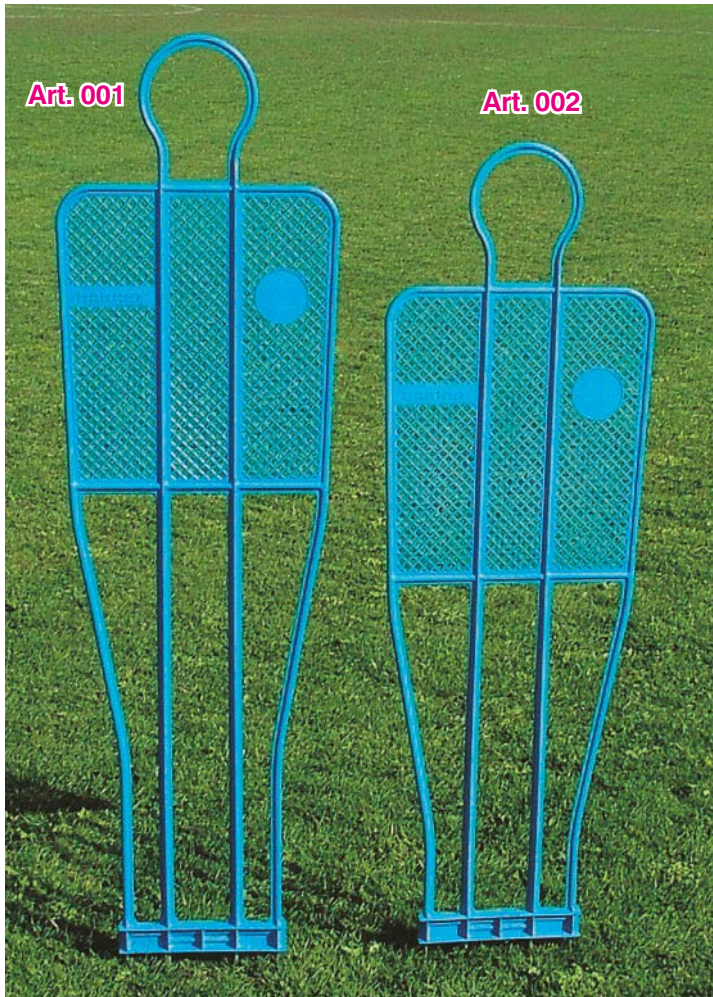

pg.1

**NUOVO MATERIALE PIÙ FLESSIBILE
NEW MORE ELASTIC PLASTIC MATERIAL**



Art. 001
Sagoma Barret brevettata
cm. 180 Kg. 3,5
Patented Barret Mannequin
cm. 180 Kg. 3,5

Art. 002
Sagoma Barret brevettata
cm. 160 Kg. 3
Patented Barret Mannequin
cm. 160 Kg. 3

Colori:
Rosso, Blu e Giallo
Colors:
Red, Blue and Yellow

SAGOME BARRET BREVETTATE
leggere, flessibili, super-resistenti,
antinfortunistiche!

PATENTED BARRET MANNEQUINS
light, flexible, strong, safe!

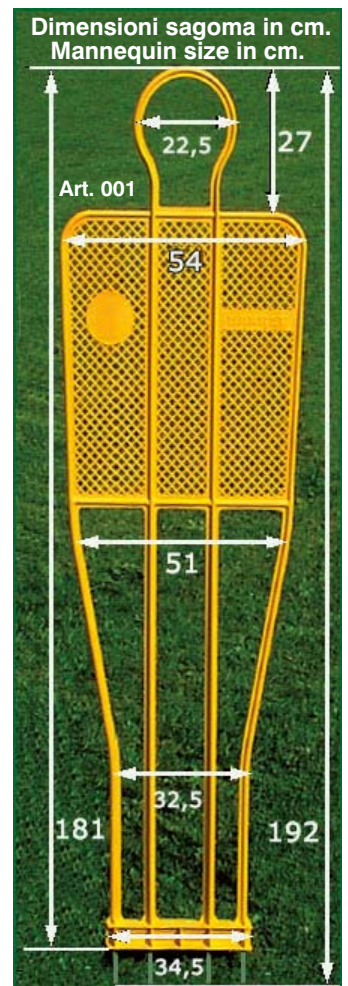

SAGOME E BARRIERE - Barriers



Art. 003 Carrello porta 5 sagome in acciaio zincato con ruote
Trolley for carrying 5 mannequins in galvanized steel, with wheels



**4 puntali in acciaio zincato alla base
per posizionamento su
terreno naturale
o su carrello porta sagome**
4 galvanized steel spikes at the base,
for easy positioning on natural grass
or upon Barret trolley

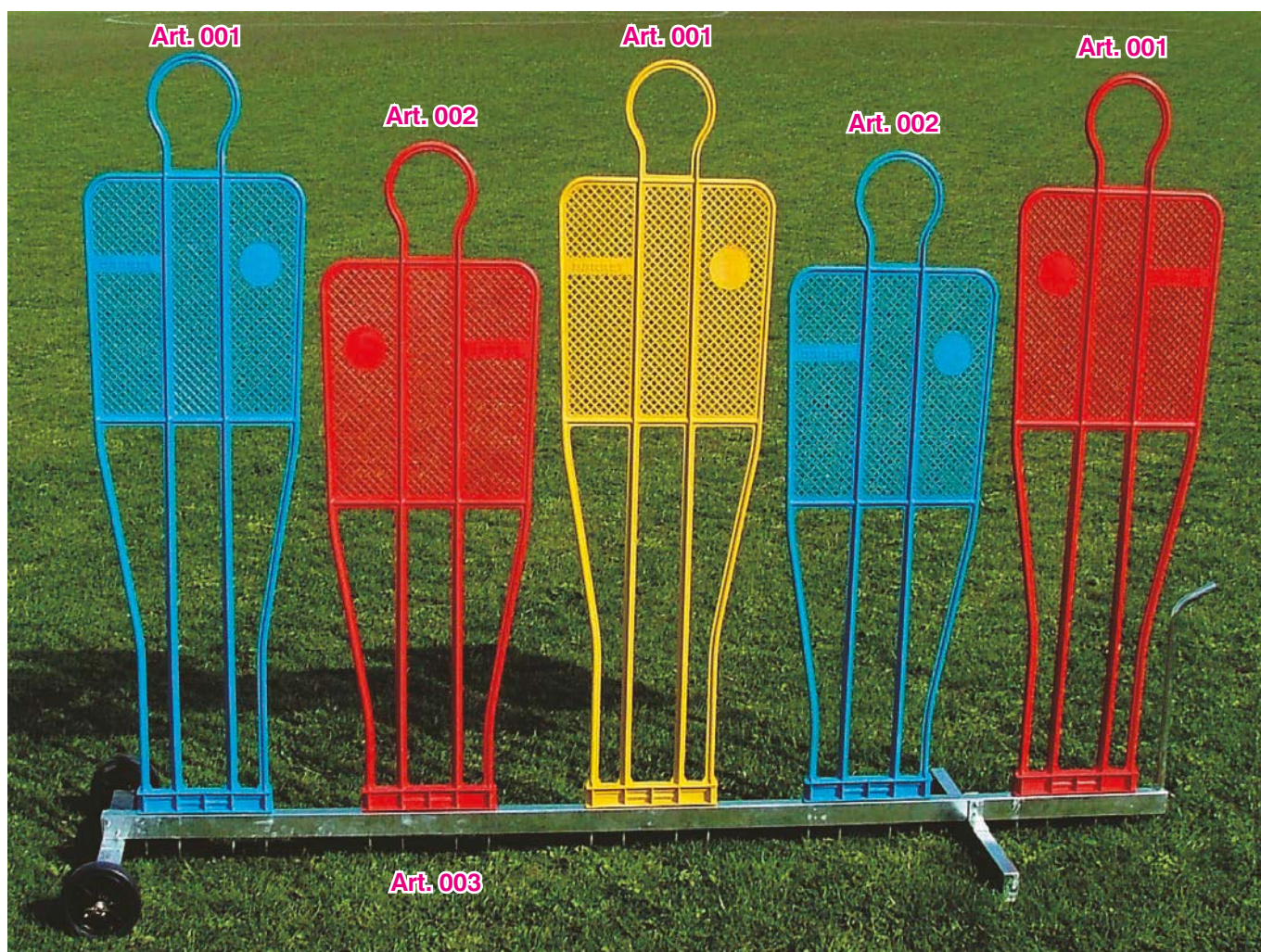

3 x Art. 001 + 2 x Art. 002 + Art. 003

SAGOME BARRET BREVETTATE

indispensabili per:
*calci di punizione, slalom, dribbling,
esercizi di anticipo, uscite aeree,
schemi tattici ...*

PATENTED BARRET MANNEQUINS

very useful for:
*free kicks, slalom, dribbling, tackles,
headers, goalkeeper exercises, tactics ...*



pg.1

Video dimostrativo disponibile su www.barretsport.com
Video available on www.barretsport.com



Art. 003RG

Carrello porta 5 sagome in acciaio zincato con ruote - regolabile a 4 altezze (la sagoma Art. 001 può arrivare ad un'altezza massima da terra di cm.225)
Trolley for 5 mannequins in galvanized steel, with wheels - 4 adjustable heights
(Art. 001 can reach up to 225 cm. height)

Il carrello regolabile in altezza permette di simulare la presenza di giocatori in barriera che saltano al momento del calcio di punizione
This trolley allows free kick practicing by simulating jumping defenders

pg.1



3 x Art. 001 + 2 x Art. 002 + Art. 003RG



Art. BPS001

Borsa porta 5 sagome in nylon impermeabile con tracolla e maniglie, rinforzi laterali in polipropilene rigido
Nylon carrying bag for 5 mannequins with shoulder belt and handles waterproof - reinforced on both sides



Art. 001
+ Art. 003S

Art. 003S Carrello porta sagoma in acciaio zincato con ruote, con molle antibaltamento
Trolley for single mannequin in galvanized steel with springs, on wheels

pg.1

Grazie alle molle il carrello Art. 003S impedisce alla sagoma di cadere a terra se colpita dalla palla
Thanks to the springs trolley Art. 003S allows mannequin to come back straight up when hit by the ball



Art. 003S



Art. 001B



Art. 001
+ Art. 001B

Art. 001B
Base per sagoma zavorrabile in acciaio zincato, per posizionamento su terreni sintetici

Peso:
kg. 10 vuota,
kg. 20 riempita con sabbia
Galvanized steel base to be filled with sand for mannequin positioning on artificial grass.
Weight: 10 kg. empty
20 kg. filled with sand



Art. 002R

Art. 001R

Art. 001R
Rivestimento per Sagoma cm. 180 in nylon impermeabile antistrappo con cerniera
Colori: rosso, blu, giallo
Nylon Cover for cm. 180 Mannequin with zip
Colors: red, blue, yellow

Art. 002R
Rivestimento per Sagoma cm. 160 in nylon impermeabile antistrappo con cerniera
Colori: rosso, blu, giallo
Nylon Cover for cm. 160 Mannequin with zip
Colors: red, blue, yellow



5 x Art. 001 + 5 x Art. 001R



5 x Art. 001 + 5 x Art. 001R
+ Art. 003RG

pg.1



LATO POSTERIORE
BACK SIDE



Art. 001FE

Art. 001FE
Sagoma Barret
in acciaio zincato
con 4 puntali
altezza cm.180
peso kg.5
 Barret mannequin
 180 cm. height
 in galvanized steel
 with 4 spikes
 weight 5 Kg.



Art. 001FE
 + Art. 001B



Art. 001FE
 + Art. 001R
 + Art. 001B

pg.1



Art. 002FE

Art. 002FE
Sagoma Barret in acciaio
zincato con 4 puntali
altezza cm.160
peso kg.4,5

Barret mannequin
 160 cm.
 height in galvanized steel with
 4 spikes weight 4,5 Kg.



3 x Art. 001FE + 2 x Art. 001R
 2 x Art. 002FE + 2 x Art. 002R
 + Art. 003



Art. 001TD Rivestimento tridimensionale per sagoma Art. 001
h. cm. 180 spessore cm. 20
in PVC bispalmato 600 gr/mq
imbottitura in gommapiuma d. 16 kg/mc
3D Cover 20 cm. thick
for mannequin Art. 001
180 cm. height

I rivestimenti tridimensionali simulano perfettamente il volume del corpo dei giocatori permettendo una serie di esercizi tecnici e tattici con e senza palla ancora più realistici e sicuri. L'imbottitura è inoltre utile per proteggere la sagoma dagli urti della palla calciata ad alta velocità durante l'allenamento ai calci piazzati di potenza



3D Covers perfectly resemble players' bodies allowing even more realistic and safe technical and tactical exercises with and without ball.

The soft sandwich protections also avoid possible damages caused by high power free kick practising



● pg.1

Art. 002TD Rivestimento tridimensionale per sagoma Art. 002
h. cm. 160
spessore cm. 20
in PVC bispalmato
600 gr/mq
imbottitura in gommapiuma
d. 16 kg/mc
3D Cover 20 cm. thick
for mannequin Art. 002
160 cm. height



Art. GP170

Sagoma in gommapiuma
h. cm. 170 - rivestimento in PVC
con decorazione digitale
fronte-retro del giocatore,
zavorrata alla base con sabbia
con maniglie per il trasporto
colori disponibili: rosso, blu,
giallo, arancio, bianco
Ø base cm. 59 - peso kg. 31
Foam rubber Dummy
170 cm. height with PVC Cover
with player's sketch
weighted base with sand
with handles
available colors: red, blue,
yellow, orange, white
base Ø 59 cm. - weight 31 kg.

**Nessun problema di
forature, perdite d'aria
o lacerazioni**
No problems with
punctures, deflation or
lacerations



← **Rivestimento in PVC**
PVC Cover outside

← **Imbottitura in
poliuretano espanso**
Foam rubber inside

pg.1

Art. GP205

Sagoma in gommapiuma
h. cm. 205 - rivestimento in PVC
con decorazione digitale
fronte-retro del giocatore,
zavorrata alla base con sabbia
con maniglie per il trasporto
colori disponibili: rosso, blu,
giallo, arancio, bianco
Ø base cm. 59 - peso kg. 32
Foam rubber Dummy
205 cm. height with PVC Cover
with player's sketch
weighted base with sand
with handles
available colors: red, blue,
yellow, orange, white
base Ø 59 cm. - weight 32 kg.

← **Maniglia
su entrambi i lati**
Handle on both
sides

← **Base zavorrata**
Weighted base

Art. GP170SL
Sagoma in
gommapiuma
come Art. GP170
solo con logo
BARRET (senza
la decorazione
del giocatore)
Foam rubber
Dummy same of
Art. GP170
only with BARRET
logo (without
player's sketch)



Art. GP205SL
Sagoma in
gommapiuma
come Art. GP205
solo con logo
BARRET (senza
la decorazione
del giocatore)
Foam rubber
Dummy same of
Art. GP205
only with BARRET
logo (without
player's sketch)

Art. SAG205
Sagoma Gonfiabile
h.cm.205
Inflatable dummy
205 cm. height

SEMPRE IN PIEDI
POP UP DUMMIES

NUOVO PVC/PU ANCORA
PIÙ RESISTENTE
NEW STRONGER PVC/PU



pg.1

Art. SAG175
Sagoma Gonfiabile h.cm.175
Inflatable dummy
175 cm. height



Art. SAG115
Sagoma Gonfiabile h.cm.115
Inflatable dummy 115 cm. height

Ideale per i bambini
delle scuole calcio
best for soccer school kids



Ø base cm. 56 - peso kg. 23
(pronta all'uso)
base Ø 56 cm. - weight 23 Kg.
(when ready for use)

Ø base cm. 45 - peso kg. 11
(pronta all'uso)
base Ø 45 cm. - weight 11 Kg.
(when ready for use)

Ø base cm. 40 - peso kg. 7
(pronta all'uso)
base Ø 40 cm. - weight 7 Kg.
(when ready for use)

Art. KSG Kit di riparazione per sagoma gonfiabile
(n. 1 confezione di collante + n. 3 porzioni di rivestimento)
Repairing Kit for inflatable dummies (glue and 3 patches)

Per un ordine minimo di 100 pezzi per misura le sagome gonfiabili possono essere personalizzate
Inflatable dummies can be customized: minimum order 100 pieces for each size

Se colpite dalla palla o dal corpo dei giocatori durante gli esercizi, le sagome gonfiabili Barret tornano in piedi da sole

Barret inflatable dummies always pop back up when hit by ball or players' body during exercises

Nate per l'allenamento dei portieri, le sagome gonfiabili Barret possono essere utilizzate anche per i calciatori per l'effettuazione di una molteplicità di esercizi tecnici e tattici con e senza palla
Born for GK training, Barret inflatable dummies are very useful for lots of tactical and technical exercises involving players with and without ball



Particolare della valvola superiore (rientrante) da utilizzare per la gonfiatura della sagoma e della valvola inferiore (anch'essa rientrante) da utilizzare per il riempimento della base di appoggio a terra con acqua
The upper valve to inflate the body with air, the bottom valve to fill the base with water

ISTRUZIONI PER LA GONFIATURA E L'UTILIZZO DELLE SAGOME GONFIABILI

IMPORTANTE: LA SAGOMA NON DEVE MAI ESSERE COMPLETAMENTE GONFIA. IL CORPO DEVE RIMANERE SEMPRE MORBIDO, ED I FIANCHI NON DEVONO ESSERE MARCATAMENTE SPORGENTI VERSO L'ESTERNO RISPETTO ALLA BASE

(UNA ECCESSIVA QUANTITÀ D'ARIA LOGORA LE SALDATURE ED ACCORCIA LA VITA DEL PRODOTTO)

- 1) Gonfiare la sagoma solo moderatamente
- 2) Tenendo la sagoma distesa a terra, inserire acqua nel serbatoio: quando la sagoma comincia ad inclinarsi verso l'alto, chiudere il tappo del serbatoio e disporla in posizione verticale
- 3) Provare a spingere la sagoma lateralmente e osservare come torna in posizione eretta
- 4) Se si vuole che la sagoma si rialzi più velocemente, aggiungere dell'acqua (a discapito del peso) e gonfiare un po'
- 5) Se si gonfia ulteriormente la sagoma, distenderla a terra e fare uscire l'aria in eccesso dal serbatoio dell'acqua (il fondo deve essere piatto, non bombato)
- 6) E' importante **utilizzare la minima quantità di acqua** che permette alla sagoma di risalire nel modo desiderato (un peso eccessivo e non giustificato può logorare inutilmente le saldature, accorciando la vita del prodotto)
- 7) Una volta trovato l'equilibrio desiderato, la sagoma può essere sgonfiata e rigonfiata (ad esempio, per trasportarla in luogo lontano) senza più svuotare il serbatoio dell'acqua
- 8) Non utilizzare le sagome se la temperatura è più bassa di 5 °C (e in ogni caso non usarle se l'acqua nel serbatoio è ghiacciata)
- 9) Non colpire le sagome con corpi appuntiti, non avvicinarle a fonti di calore, non trascinarle ma sollevarle sempre con le maniglie quando occorre spostarle, non sbatterle violentemente a terra, non lasciarle esposte al sole per giorni
- 10) Per le riparazioni utilizzare l'apposito kit o Loctite 406 (altri prodotti non hanno efficacia sul materiale) Il prodotto è garantito solo per un utilizzo diligente che rispetti le istruzioni fornite



Art. KSG
Kit di riparazione
(collante +
3 porzioni di
rivestimento)
Inflatable dummy
repairing kit



**SEMPRE IN PIEDI
POP UP DUMMIES**



USER'S INSTRUCTIONS

IMPORTANT: YOU ALWAYS HAVE TO KEEP THE BODY OF YOUR DUMMY VERY SOFT (NOT FULLY INFLATED) AND HIPS HAVE TO BE IN A STRAIGHT LINE WITH THE BASE (THEY MUST NOT BE ROUNDED).

AN EXCESSIVE AMOUNT OF AIR WILL WEAR OUT THE WELDS AND SHORTEN THE TOOL'S LIFE

Inflatable dummies are entirely made of soft PVC/PU: there are no rigid parts, so these products are absolutely safe. First, you have to inflate your dummy but not completely. Then, by keeping it lying on the floor, you have to put some water in the tank: when the dummy rises up, close the valve and place it upright.

If you want your dummy to rise up more quickly when hit, add some water and inflate the body a little more. In this case, let the dummy lie on the floor for a while and let some air out from the tank (the base must be flat, not rounded). It's important you **to use the minimum amount of water** that allows your dummy to rise the desired way (an excessive and unjustified weight will wear out the welds, shortening the tool's life).

Once the desired balance has been found, the dummy can be deflated and re-inflated without emptying the water tank (for example, when you need to transport it to a distant place).

Dummies can be used both on natural and artificial grass, on turf, gym floors etc.

Two side handles made of soft PVC are very useful to carry your dummy around: it is important to always lift your dummy when you need to move it (never pull it!) so the base doesn't get damaged.

Do not use dummies if the temperature is lower than 5 °C (and in any case do not use them if the water in the tank is frozen).

It is also available a kit for repair when inflatable dummies get damaged because used in wrong ways, in example when they are torn apart by players kicking with their studs against them.



pg.1

Art. 706244
Sagoma in plastica rinforzata antiurto
su carrello a 4 ruote
altezza cm.190
peso totale Kg.22
(kg.7 la sagoma - Kg.15 il carrello)
spessore sagoma cm.9
 Mannequin in reinforced plastic
 9 cm. thick with 4 wheel trolley
 height 190 cm. weight 22 Kg.

LATO ANTERIORE
FRONT

LATO POSTERIORE
BACK

pg.1

Art. 5026
Sagoma
Barret
in vetroresina
h. cm. 185
 Barret
 fiberglass
 Mannequin
 185 cm. height

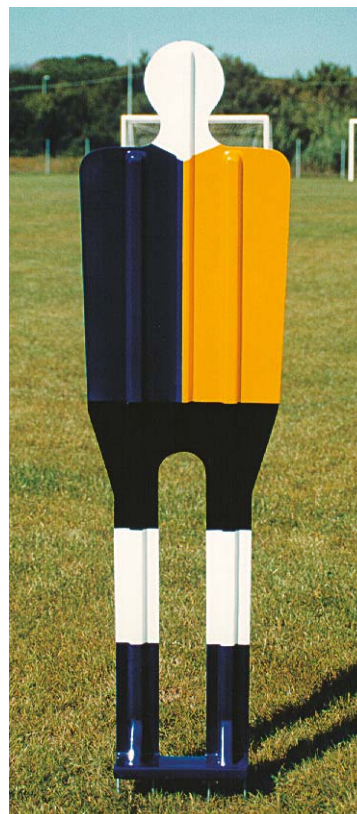

Indistruttibili!
Unbreakable!

4 puntali in acciaio
zincato alla base, per
posizionamento su
terreno naturale
o su carrello
portasagome

4 galvanized steel
 spikes at the base, for
 quick positioning on
 natural grass
 or on trolley

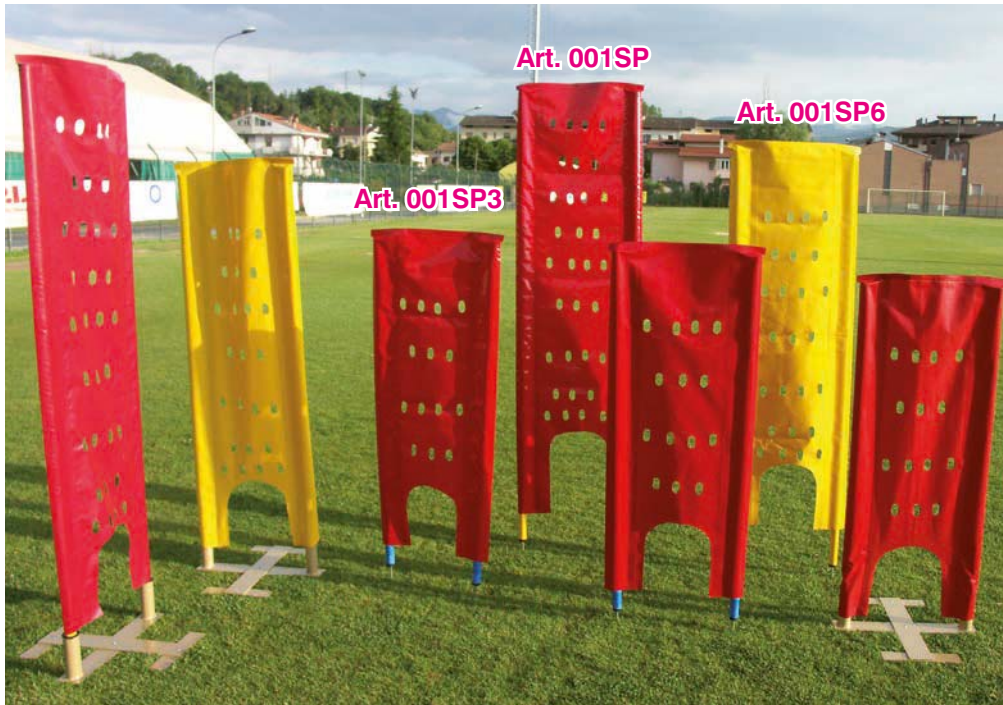

Art. 001SP
Sagoma Morbida con telo PVC forato antivento su 2 Paletti in PVC h. cm. 170 con puntale
 Soft pierced antiwind PVC Mannequin on 2 PVC Poles 170 cm. high with metal spike

Art. 001SP3
Sagoma Morbida con telo PVC forato antivento su 2 Paletti in PVC h. cm. 130 con puntale
 Soft pierced antiwind PVC Mannequin on 2 PVC Poles 130 cm. high with metal spike

Art. 001SPA
Sagoma Morbida con telo PVC forato antivento su 2 Paletti in alluminio h. cm. 170 con puntale
 Soft pierced antiwind PVC Mannequin on 2 aluminium Poles 170 cm. high with metal spike

pg.1

Art. 001SP6
Sagoma Morbida con telo PVC forato antivento su 2 Paletti in PVC h. cm. 160 con puntale
 Soft pierced antiwind PVC Mannequin on 2 PVC Poles 160 cm. high with metal spike



Art. SA001
Supporto per sagoma morbida in ferro verniciato utilizzabile su terreno sintetico
 Base in painted iron for positioning any soft mannequin on artificial grass



PALETTI SLALOM - Slalom Poles



Art. 007
Paletto cm. 170
in PVC Ø mm. 32
con puntale zincato
colore giallo, giallo fluo,
rosso, bianco, blu, arancio
 Pole 170 cm. high
 in PVC with
 galvanized metal spike
 colors: yellow, fluo yellow,
 red, white, blue, orange

pg.1



Art. 007SP
Paletto senza puntale
cm. 162
in PVC Ø mm. 32
colore giallo fluo,
rosso, bianco, blu
 Pole 162 cm. high
 in PVC
 colors: fluo yellow,
 red, white, blue

pg.1

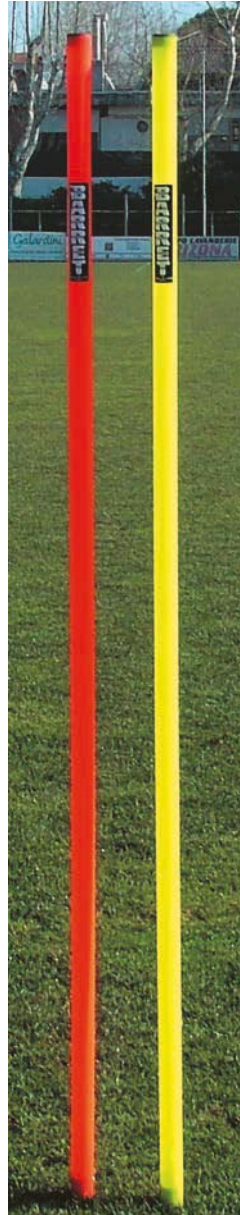

Art. 007F
Paletto in polipropilene
copolimero Ø 32 mm.
h.cm.163
con puntale zincato,
colore giallo o arancio
fluorescente
 Pole 163 cm. height in
 copolymer polypropylene
 32 mm. with galvanized metal
 spike - colors: fluorescent
 yellow and orange



Art. P007 pg.2
Paletto cm. 160
in polipropilene
Ø mm. 30 con
puntale e piattello
di appoggio,
colore giallo
o arancio
fluorescente
 Pole 160 cm. h. in
 polypropylene,
 metal spike with ring
 colors: fluorescent
 yellow and orange

Art. BFT
Borsa porta paletti
(capienza massima
30 pezzi)
 Bag containing
 30 poles



pg.2



pg.2



Art. A007
Paletto cm. 170
in alluminio Ø mm. 32
con puntale zincato
Pole 170 cm. high
in aluminium with
galvanized metal spike

Art. S007
Paletto flessibile
cm. 170 in
PVC Ø mm. 32 con
puntale
zincato e molla,
colore giallo o rosso
Pole 170 cm. h.
in PVC with
galvanized metal
spike and spring
colors: yellow, red



Art. AS007
Paletto flessibile
cm. 170 in
alluminio Ø mm.
32 con puntale
zincato e molla
Pole 170 cm. h.
in aluminium with
galvanized metal
spike and spring



cm. 170



cm. 90



Art. 007TL
Paletto telescopico
Ø 32 mm
h. cm. 170 in PVC
con puntale zincato
(l'altezza si riduce
fino a cm.90)
colore giallo
Telescopic Pole h. 170
cm. in PVC with galvanized
metal spike
Height can be reduced
down to 90 cm.
color yellow



pg.2



Art. 007.25
Paletto
cm. 170
smontabile
in PVC
Ø 25 mm
con puntale
zincato svitabile
colore giallo
Dismountable
Pole 170 cm.
height in PVC
with removable
galvanized metal
spike
color yellow





Art. 018

Base ad imbuto
in plastica per
paletto Ø 32 mm
con o senza puntale

Funnel-shaped plastic base for
pole with or without metal spike



Art. 902013

Base cilindrica in plastica
riempibile con sabbia o
acqua, solo per paletto
Ø 32 mm senza puntale

Cylindrical plastic base to
be filled with sand or water,
only for pole without
metal spike

pg.2



Art. HWRB

Base in gomma
appesantita
per paletto Ø 32 mm
con o senza puntale
Weighted Rubber base
for pole with
or without metal spike



Art. SP202 Base ad imbuto
in plastica riempibile con
sabbia, solo per paletto
Ø 32 mm senza puntale
Funnel-shaped plastic base
to be filled with sand, only for
pole without metal spike



h. cm. 173

Art. 010

Kit paletto PVC
Ø 32 mm
senza puntale
Art. 007SP
+ base Art. 018
Kit pole without
metal spike
+ base Art. 018



h. cm. 170

Art. 010C

Kit paletto PVC
Ø 32 mm
senza puntale
Art. 007SP
+ base Art. 902013
Kit pole without
metal spike
+ base Art. 902013



h. cm. 176

Art. 010WR

Kit paletto PVC
Ø 32 mm
senza puntale
Art. 007SP
+ base Art. HWRB
Kit pole without
metal spike
+ base Art. HWRB



Art. SP25

Asta in PVC
Ø 25 mm.
altezza
cm. 152
PVC pole
Ø 25 mm.
height
152 cm.

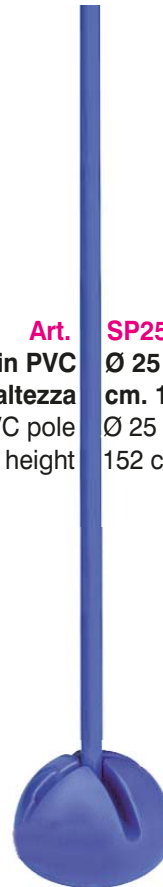

Art. TAH-X

Base riempibile
con sabbia per
aste Ø 25 mm.
e cerchi piatti
o tubolari
Base to be filled
with sand for poles
Ø 25 mm. and flat
or tubular hoops

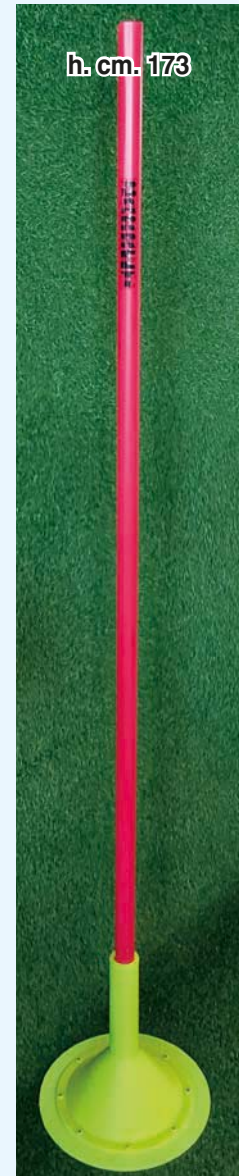

h. cm. 173

Art. S111P Kit paletto PVC
Ø 32 mm senza puntale
Art. 007SP
+ base Art. SP202
Kit pole without metal spike
+ base Art. SP202

DELIMITATORI - Markers

SPECIFICARE I COLORI RICHIESTI AL MOMENTO DELL'ORDINE

PLEASE, SPECIFY COLORS IN YOUR ORDER



Art. 016

Kit 48 Delimitatori h. cm.5 con rimessaggio colori disponibili:

giallo fluo, rosso, fucsia, arancio fluo, blu, bianco

Kit 48 Markers h. 5 cm. with holder

(colors: fluo yellow, red, fuchsia, fluo orange, blue, white)

Art. 016.1

Kit 48 Delimitatori h. cm.5 senza rimessaggio

(come articolo 016)

Kit 48 Markers h. 5 cm. without holder

pg.3



Art. 016.R5 Rimessaggio in plastica per delimitatori h. cm.5 e cm.7

Plastic Holder for 5 cm. and 7 cm. height markers



Art. 016.B

Kit 48 Delimitatori h. cm.8 con rimessaggio giallo fluo, rosso, fucsia, arancio fluo, blu, bianco

Kit 48 Markers 8 cm. height with holder

(fluo yellow, red, fuchsia, fluo orange, blue, white)



Art. 016.R

Rimessaggio in ferro per delimitatori h. cm.8 e delimitatori giganti Art. 016.K

Iron Holder for 8 cm. and giant markers



Art. 016-TDC

Raccoglitore in plastica per delimitatori con manico allungabile

Adjustable length picking device for markers



Art. 016.T



Art. 016.T

Kit 48 Delimitatori h. cm. 7 con rimessaggio e intagli sulla sommità

colori disponibili: giallo e rosso

Kit 48 Markers with holder 7 cm. height carved on top (colors: red and yellow)

Art. OSPT15 Delimitatore circolare piatto Ø cm.15 spessore mm.1 colori giallo, rosso, arancio e bianco
Flat round Marker Ø 15 cm. colors: red, yellow, orange and white

Ideali per superfici sintetiche
Great for indoor and turf

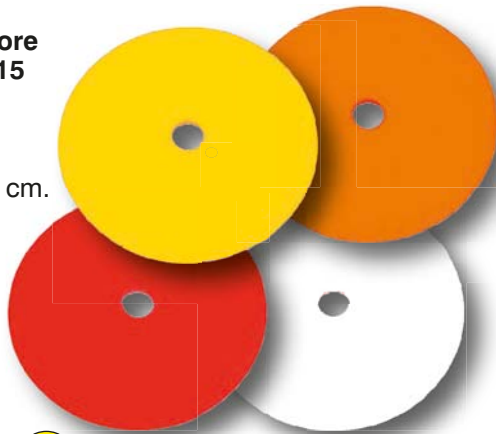

pg.3

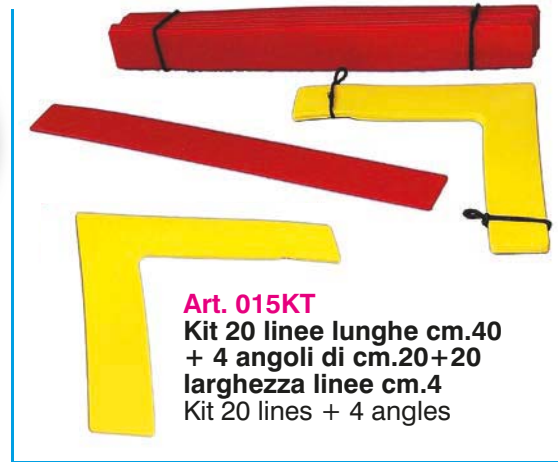

Art. 015KT
Kit 20 linee lunghe cm.40 + 4 angoli di cm.20+20 larghezza linee cm.4
Kit 20 lines + 4 angles

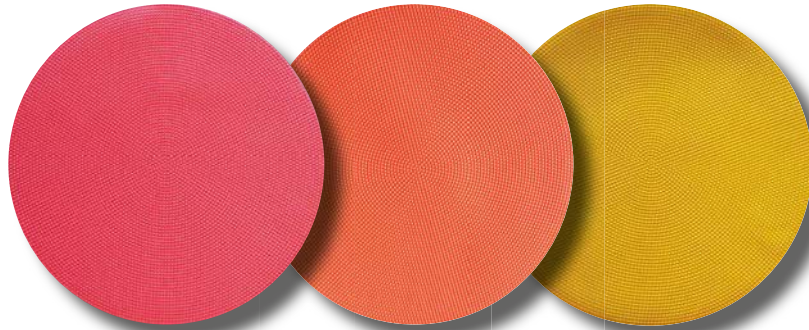

Art. DC25
Delimitatore circolare piatto Ø cm.25 spessore mm.1 colori giallo, rosso, arancio
Flat round Marker Ø 25 cm. colors: red, yellow, orange



Art. 016.K
Delimitatore gigante con scanalature base Ø cm. 30 h. cm.16,5 peso gr. 100 colori: giallo, arancio e bianco
Giant Marker 16,5 cm. height carved on top and sides colors yellow, orange and white

Art. 016.K

pg.3

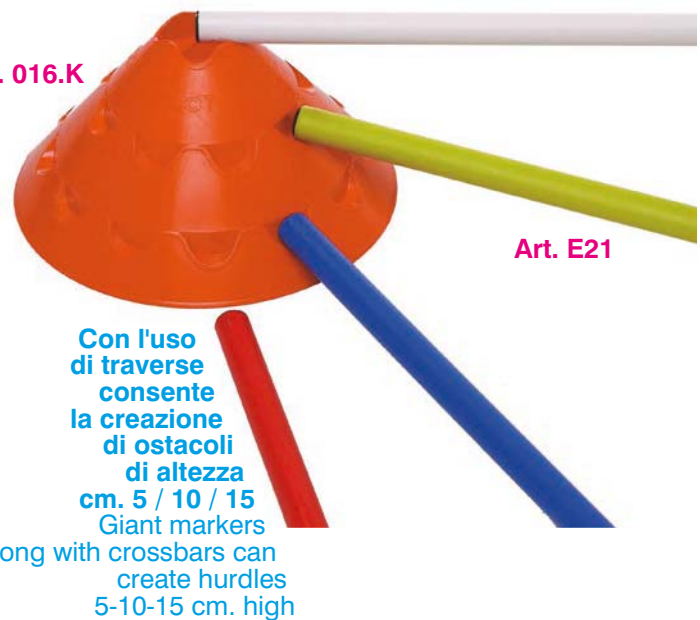

Art. E21

Con l'uso di traverse consente la creazione di ostacoli di altezza cm. 5 / 10 / 15
Giant markers along with crossbars can create hurdles 5-10-15 cm. high



Art. E21 Traversa cm.120 in PVC Ø mm. 25 - colori giallo, rosso, blu, verde, bianco
Crossbar 120 cm. in PVC Ø 25 mm. - colors yellow, red, green, blue, white

pg.3

BIRILLI - Cones

Art. 205000
Birillo calpestabile
in caucciù termoplastico
base Ø cm. 14 - h. cm. 15
colori giallo e rosso
Soft Cone 15 cm. height
14 cm. Ø base
colors: red, yellow



Art. HA7
Birillo calpestabile
in caucciù
termoplastico
base Ø cm. 17
h. cm. 18
colori giallo e rosso
Soft Cone
18 cm. height and
17 cm. Ø base
colors: red, yellow

pg.3



Art. 019

Art. 019
Kit 24 Maxidelimitatori h. cm. 28
colori: giallo, arancio, rosso,
royal e fucsia
Kit 24 Maximarkers, height 28 cm.
colors: yellow, orange, red, blue
and fuchsia

Art. 019.1
Maxidelimitatore h. cm. 28
fornito singolarmente
colori: giallo, arancio, rosso,
royal e fucsia
Loose Maximarker height 28 cm.
colors: yellow, orange, red, blue
and fuchsia

pg.3

Art. 023E
Birillo economico senza fori h. cm. 30
colori rosso e giallo
Light Cone 30 cm. height with no holes
colors: red, yellow





Art. 023N

Birillo h. cm. 38 colore rosso, giallo o blu - Cone height 38 cm. colors: red, yellow, blue
Peso gr. 200 senza foro sulla sommità - Weight 200 gr. with no hole at top



Art. 023

Birillo giallo h. cm. 40 con foro sulla sommità
 Yellow Cone 40 cm. height with hole at the top

Art. 025

Birillo fucsia h. cm. 40 con foro sulla sommità
 Fuchsia Cone 40 cm. height with hole at the top

Art. 024

Birillo rosso h. cm. 40 con foro sulla sommità
 Red Cone 40 cm. height with hole at the top

● pg.3



Art. B312

Birillo a 8 fori h. cm. 30 con scanalatura sulla sommità
 Cone with 8 holes 30 cm. height carved on top



Art. E21 Traversa cm.120 in PVC Ø mm. 25

colori giallo, rosso, blu, verde, bianco

Crossbar 120 cm. in PVC Ø 25 mm. - colors yellow, red, green, blue, white



Art. I-111
Clip rotante
per aste
Ø mm. 25 e 28
 Rotating clip
 for two pipes
 Ø mm. 25 and 28



Art. C21
Birillo a 16 fori
h. cm. 50
con scanalatura
sulla sommità
 Cone with 16 holes
 height 50 cm.
 carved on top

pg.3

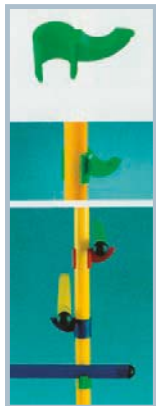

Art. I-110
Clip per montante
Ø mm. 25 e 28
e traversa
 Clip for pipe
 Ø mm. 25 and 28
 and crossbar

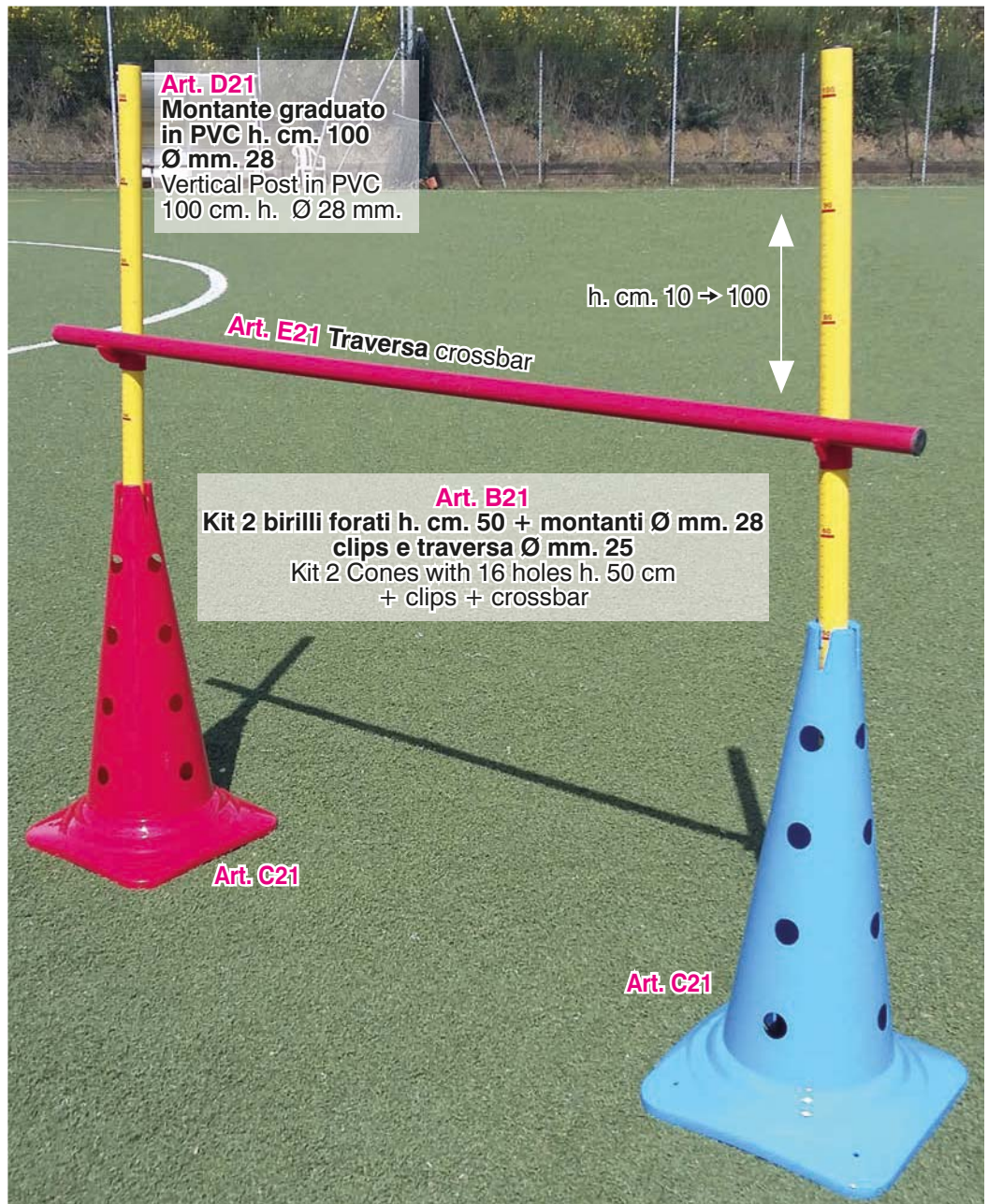

Art. D21
Montante graduato
in PVC h. cm. 100
Ø mm. 28
 Vertical Post in PVC
 100 cm. h. Ø 28 mm.

h. cm. 10 → 100

Art. E21 *Traversa crossbar*

Art. B21
Kit 2 birilli forati h. cm. 50 + montanti Ø mm. 28
clips e traversa Ø mm. 25
 Kit 2 Cones with 16 holes h. 50 cm
 + clips + crossbar

Art. C21

Art. C21



Art. I-112
Clip per asta
Ø mm. 25 e 28
e cerchio piatto
 Clip for pipe
 Ø mm. 25 and 28
 and flat hoop



Art. 525
Ostacolo regolabile con paletti, clips e traversa in PVC Ø mm.32
 Hurdle with Poles, clips and crossbar in PVC Ø 32 mm.

pg.2

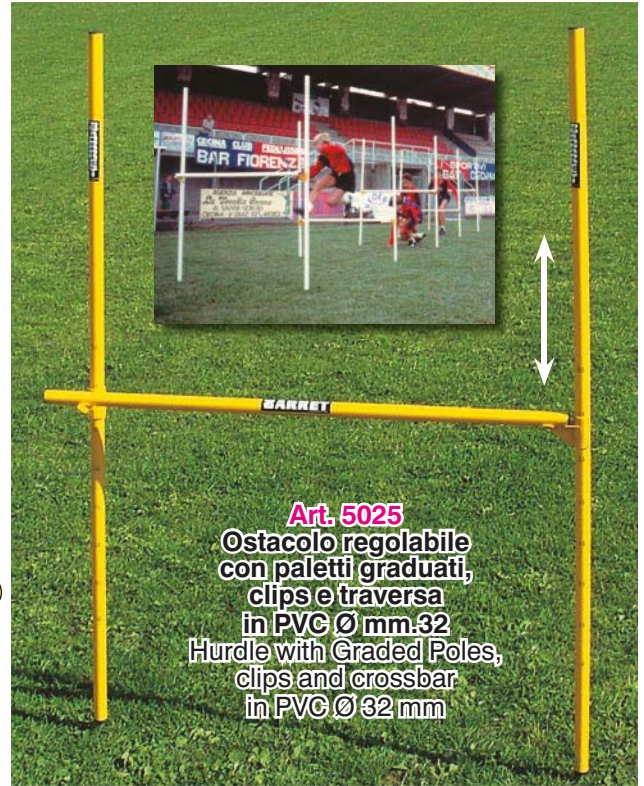

Art. 5025
Ostacolo regolabile con paletti graduati, clips e traversa in PVC Ø mm.32
 Hurdle with Graded Poles, clips and crossbar in PVC Ø 32 mm

h. cm. 10 → 160



Art. 012
Traversa in PVC cm.110 Ø mm. 32
 Crossbar 110 cm. in PVC Ø 32 mm.



Art. 012F
Traversa in polipropilene copolimero cm. 110 Ø mm.32 giallo o arancio fluo
 Crossbar 110 cm. in copolymer polypropylene Ø 32 mm. in fluorescent yellow and orange



Art. 525F
Ostacolo regolabile con paletti h. cm. 170 con puntale, 1 traversa e 2 clips in polipropilene copolimero colore giallo o arancio fluo
 Hurdle with graded poles, clips and crossbar in copolymer polypropylene Ø 32 mm. (colors: fluorescent yellow and orange)

h. cm. 10 → 160

pg.2



Art. ELNR
ELASTICO nero con velcro lunghezza cm.135 da fissare ai paletti come traversa ad altezza regolabile
 Black band length 135 cm. with velcro to be used as adjustable height crossbar

Art. 902013

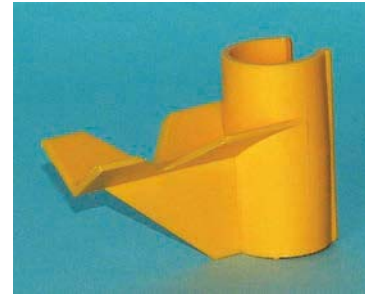

Art. 011
Clip per sostegno traversa per asta Ø mm. 32 e 28
Clip for crossbar for pipe Ø mm. 32 and 28



pg.2



Art. CL17
Clip rotante per aste Ø mm. 32
Rotating clip for two pipes Ø 32 mm.

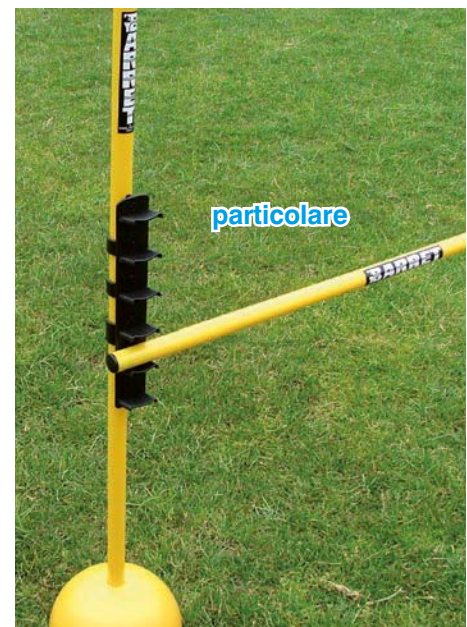
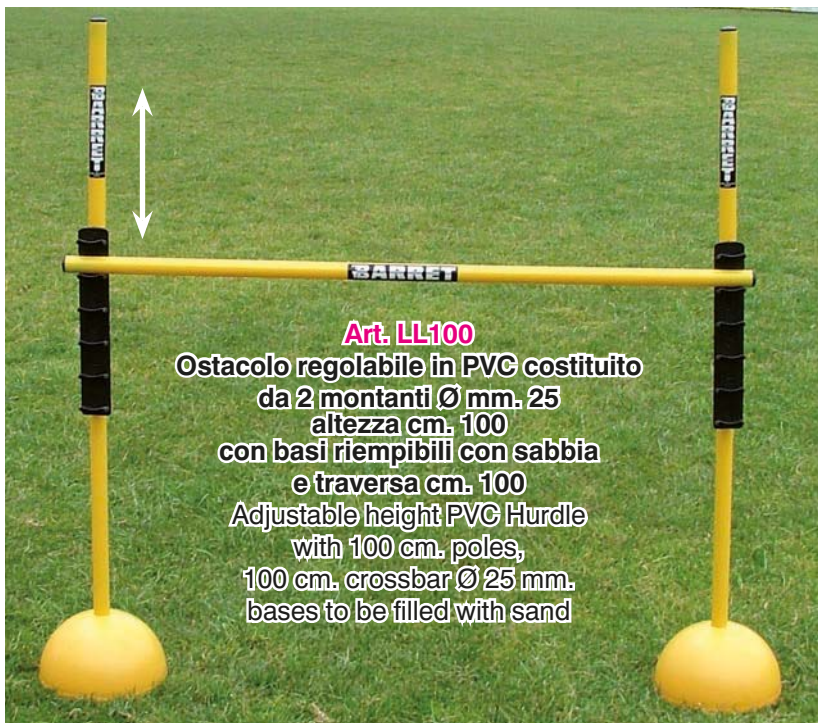

OSTACOLI - Hurdles



Larghezza traversa cm. 45
45 cm. crossbar

Molto resistenti
Highly resistant

pg.5

Art. MH6 / MH9 / MH12
Mini-Over in PVC
altezza fissa,
cm. 15 / 23 / 30
Ideali per i bambini
delle scuole calcio

Mini-Over in PVC
fixed height,
15 / 23 / 30 cm.
Best for soccer
school kids



Larghezza
Traversa cm. 80
80 cm. crossbar

Flessibili ed indistruttibili
Flexible and unbreakable



Tornano in posizione
dopo ogni urto
senza danneggiarsi
These hurdles come
back in position after
any hit without being
damaged

pg.3

pg.4



Art. 80.12 / 80.14 / 80.16 / 80.18
80.20 / 80.30 / 80.40 / 80.50 / 80.60
Ostacolo Over in PVC
altezza fissa,
cm.12-14-16-18-20-30-40-50-60
Hurdle Over in PVC
fixed height,
12-14-16-18-20-30-40-50-60 cm.

pg.4

Art.
P031-A / P031 / P032
P033 / P034 / P035
Ostacolo Over
in PVC Ø mm. 32
altezza fissa
disponibile
da 12 a 60 cm.
Hurdle Over in PVC,
fixed height
available
from 12 to 60 cm.



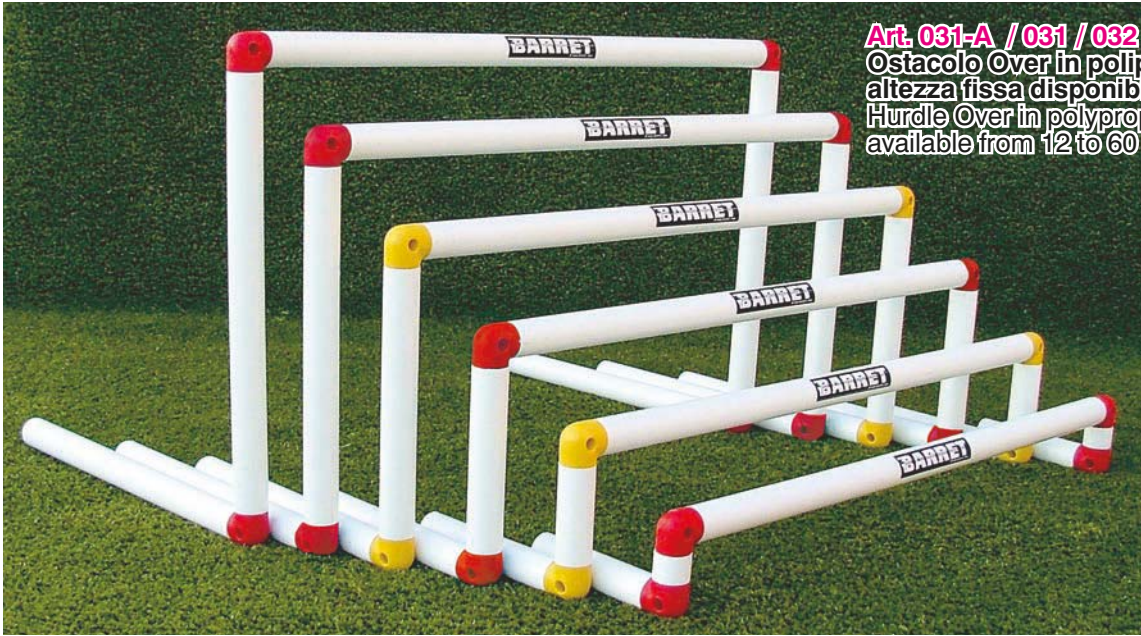

Art. 031-A / 031 / 032 / 033 / 034 / 035
Ostacolo Over in polipropilene Ø mm. 40
altezza fissa disponibile da 12 a 60 cm.
Hurdle Over in polypropylene, fixed height
available from 12 to 60 cm.

**Polipropilene
copolimero
Ø 40 mm.
altamente
resistente e
flessibile fino a
-5 gradi!**
Polypropylene
copolymer
40 mm. highly
resistant and
elastic till minus
5 degrees!

pg.4



Art. 235-1 / 235-2 / 235-3 / 235-4 / 235.5 / 235.6
Ostacolo Over
in ferro verniciato altezza fissa
disponibile da 12 a 60 cm.
Hurdle Over in painted iron,
fixed height available
from 12 to 60 cm.

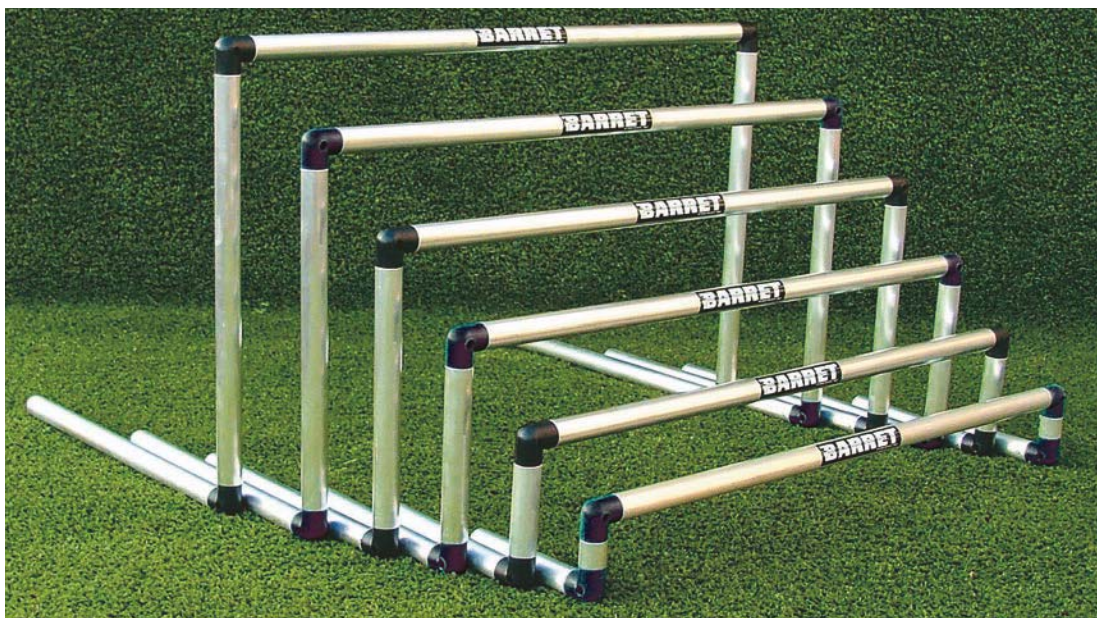

Art. A031-A / A031 / A031-B / A032 / A033 / A034 / A035
Ostacolo Over in alluminio Ø mm. 32 altezza fissa disponibile da 12 a 60 cm.
Hurdle Over in aluminium, fixed height available from 12 to 60 cm.



pg.5

Art. 239TI

Ostacolo con traversa inclinata altezza variabile da cm. 12 a cm. 60 in ferro verniciato - larghezza mt. 2 (scomponibile) Ordinare quantità multipla di 3 pezzi

Hurdle with inclined crossbar height from 12 cm. to 60 cm. in painted iron - width 2 meters (dismountable in 3 pieces) Please order multiple quantities of 3 pieces

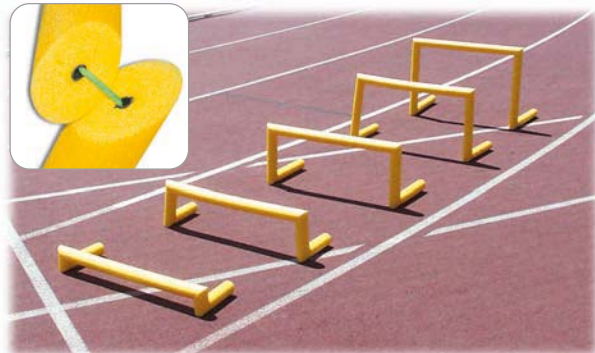

pg.5

Art. P15421

Serie 5 ostacoli Over supersoft in polietilene espanso colore giallo, leggerissimi ideali per uso indoor

altezza cm. 10-20-30-40-50 (il set comprende un ostacolo per ciascuna altezza)

Set of 5 Hurdles over supersoft yellow color very light, best for indoor use fixed height cm. 10-20-30-40-50

**Art. 031-AF
031F / 031-BF / 032F
033F / 034F / 035F**

**Ostacolo over
altezza fissa
cm. 12-20-30-40-50-60
in polipropilene
copolimero
alta resistenza
Ø mm. 32
colori: giallo e arancio
fluorescente**

Over Hurdle 12 - 20 - 30
40 - 50 - 60 cm. height
polypropylene
copolymer
pipe Ø mm. 32
(colors: fluorescent
yellow and orange)



pg.4

**Polipropilene
copolimero
FLUO
altamente
resistente e
flessibile fino a
-5 gradi!
Polypropylene
copolymer
fluorescent
highly
resistant and
elastic till minus
5 degrees!**

Art. C031 / C032 / C033 / C034

**Ostacolo Over
con cerniere (richiudibile) in
polipropilene
copolimero Ø mm. 32
colore giallo o arancio
fluorescente
massima altezza
cm. 20 - 30 - 40 - 50
Hinged Hurdle Over
(foldable) in polypropylene
copolymer pipe Ø mm. 32
fluorescent yellow and orange
20 - 30 - 40 - 50 cm.
maximum height**



pg.4



Art. 006
Ostacolo con cerniere (richiudibile)
altezza regolabile da 10 a 60 cm.
in PVC Ø mm. 32
Hinged Hurdle (foldable)
adjustable height
from 10 to 60 cm. in PVC



pg.5

Art. 006F
Ostacolo con cerniere (richiudibile)
altezza regolabile da 10 a 60 cm.
in polipropilene copolimero Ø mm. 32
colore giallo o arancio fluorescente
Hinged Hurdle (foldable) adjustable height
from 10 to 60 cm. in polypropylene
copolymer pipe Ø 32 mm.
(colors: fluorescent yellow and orange)



Art. A004 **Ostacolo con cerniere (richiudibile)**
altezza regolabile da 10 a 60 cm.
in alluminio Ø mm. 32
Hinged Hurdle (foldable) adjustable height
from 10 to 60 cm. in aluminium



Art. P0055
Ostacolo Telescopico graduato,
altezza regolabile
da 40 a 60 cm. in PVC
 Telescopic Hurdle - graded - height adjustable
 from 40 to 60 cm. in PVC



Art. P0055

Completamente smontabili,
minimo ingombro!
 Dismountable legs,
 easy to transport

pg.5



Montanti graduati in cm.
 Graded in cm.

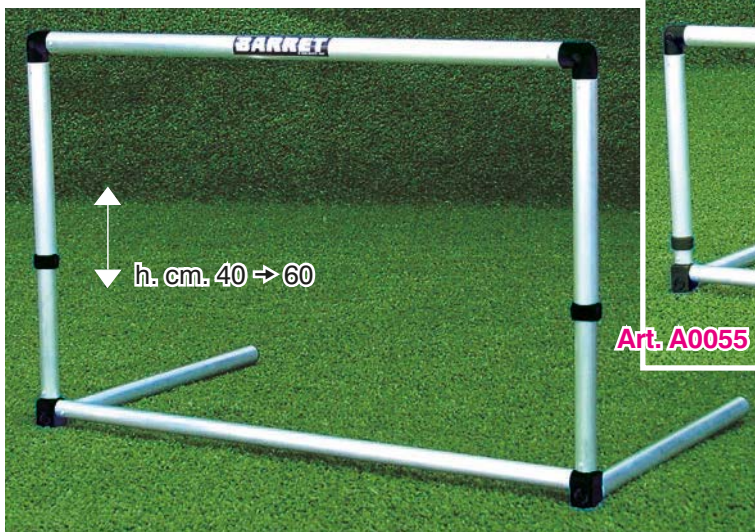

Art. A0055

Art. A0055
Ostacolo Telescopico graduato, altezza regolabile
da 40 a 60 cm. in alluminio
 Telescopic Hurdle - graded - height adjustable
 from 40 to 60 cm. in aluminium



Montanti graduati
in cm.
 Graded in cm.

Completamente smontabili,
minimo ingombro!
 Dismountable legs,
 easy to transport



Art. P005
Ostacolo Telescopico graduato,
altezza regolabile da 60 a 100 cm. in PVC
 Telescopic Hurdle - graded - height adjustable
 from 60 to 100 cm. in PVC

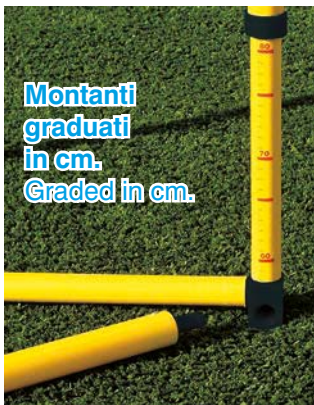
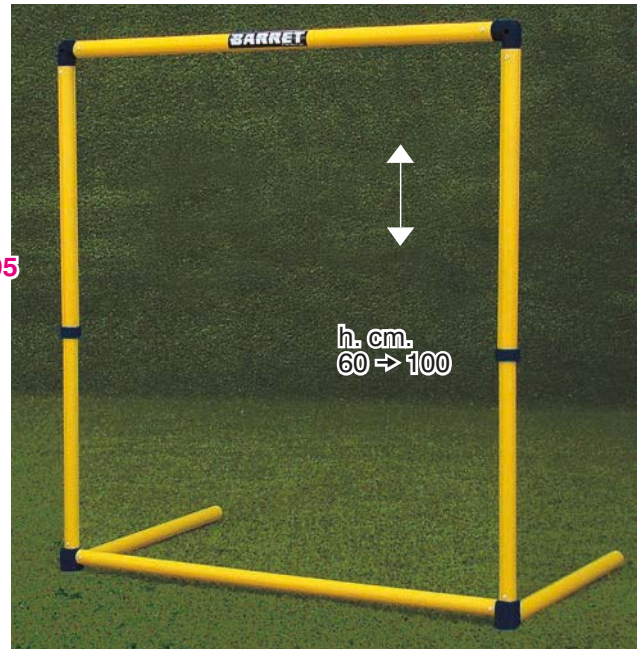
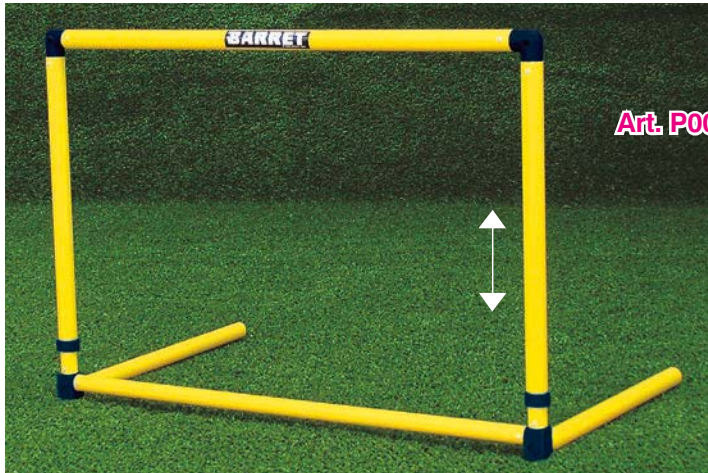

Montanti graduati in cm.
Graded in cm.

Completamente smontabili, minimo ingombro!
Dismountable legs, easy to transport

● pg.5



Art. A005
Ostacolo Telescopico graduato,
altezza regolabile da 60 a 100 cm. in alluminio
 Telescopic Hurdle - graded
 height adjustable from 60 to 100 cm. in aluminium

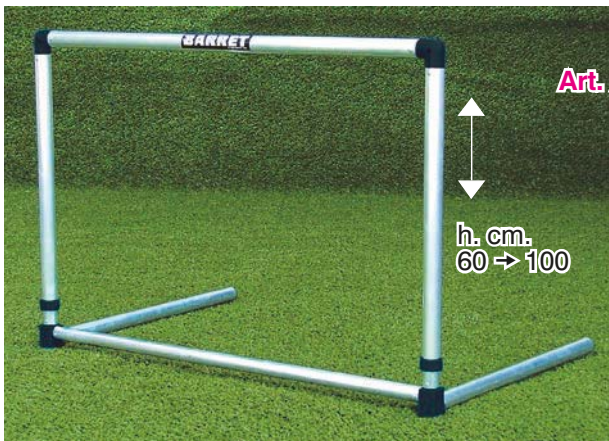

Montanti graduati in cm.
Graded in cm.

Completamente smontabili, minimo ingombro!
Dismountable legs, easy to transport



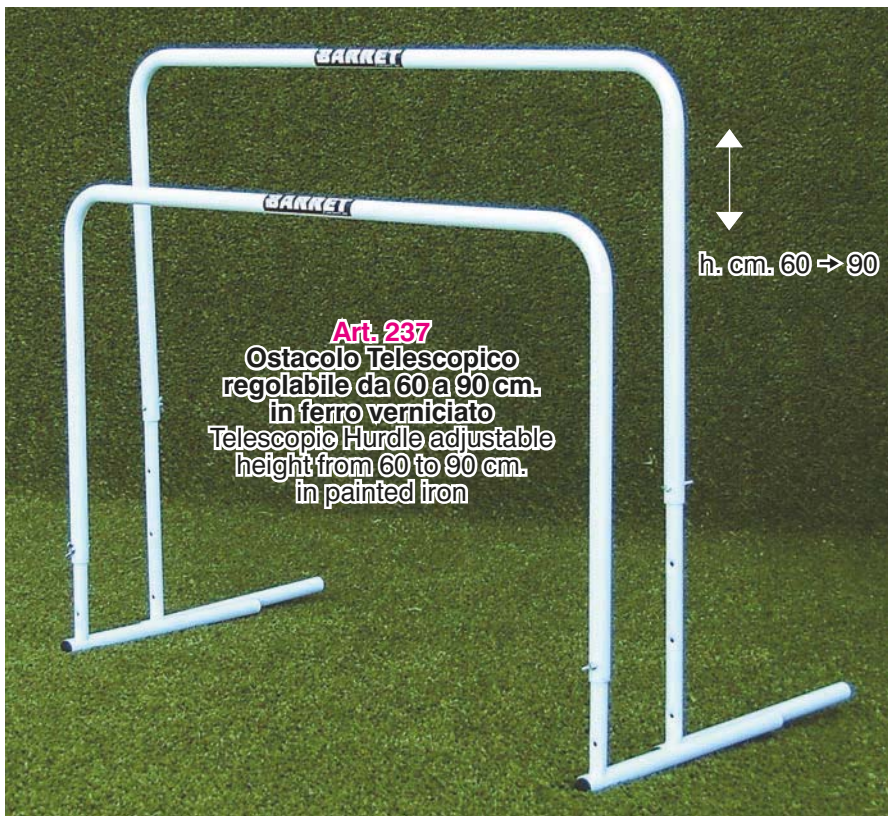
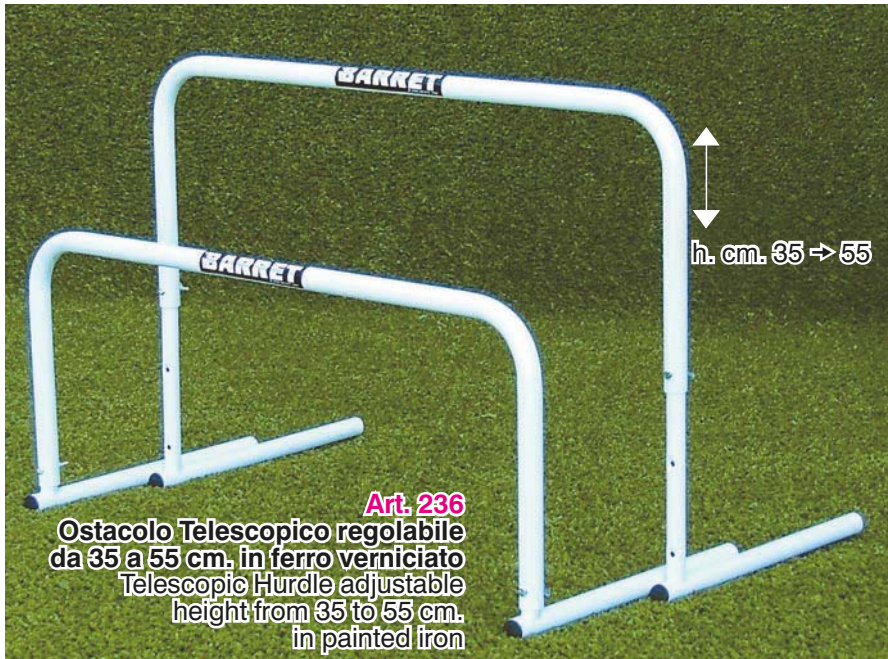

Art. H6912
Mini-Ostacolo per bambini in plastica antiurto larghezza traversa cm. 45 altezza regolabile a cm. 15-23-30
Mini-Hurdle in plastic for kids 45 cm. wide adjustable height at 15-23-30 cm.

pg.5



Art. 036
Mini-Ostacolo per bambini regolabile da 10 a 50 cm. in plastica
Mini-Hurdle for kids adjustable height from 10 to 50 cm. in plastic

IDEALI PER USO INDOOR E PER PALESTRE

For indoor use



**SEMPRE IN PIEDI
DOPO OGNI URTO!
THEY ALWAYS COME
BACK UP AFTER
ANY HIT!**

pg.5

Art. 5020 / 5021 / 5022 / 5023
Ostacolo Basculante in PVC Ø mm. 28
altezza fissa cm. 30 / 40 / 50 / 60
Self-Straightening Hurdle in PVC fixed height,
available in 30 / 40 / 50 / 60 cm.



pg.5

Art. A5020 / A5021 / A5022 / A5023
Ostacolo Basculante in alluminio Ø mm. 28
altezza fissa cm. 30 / 40 / 50 / 60
Self-Straightening Hurdle in aluminium
fixed height, available in 30 / 40 / 50 / 60 cm.

**SEMPRE IN PIEDI
DOPO OGNI URTO!
THEY ALWAYS COME
BACK UP AFTER
ANY HIT!**



KIT CALCIO TENNIS - Soccer Tennis Kits

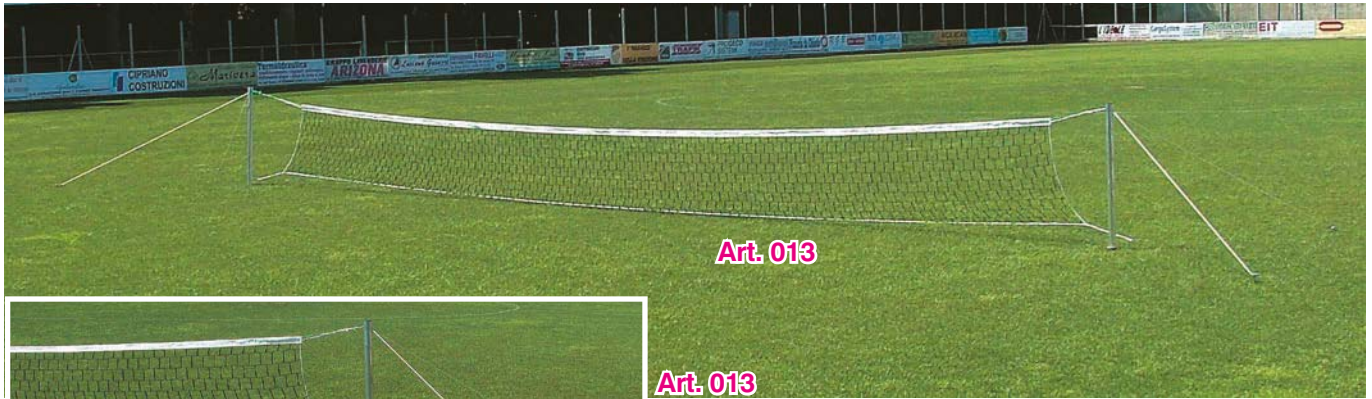

Art. 013



Art. 013

Kit Calcio Tennis pali in alluminio sezione mm. 60 completo di rete mt. 9,85 con tiranti, picchetti e nastro di delimitazione, utilizzabile solo su terreni naturali
Soccer Tennis Kit aluminium poles 60 mm. with 9,85 meter net, tightening ropes, pegs and tape for bounds - for natural grass

pg.6



Art. 014

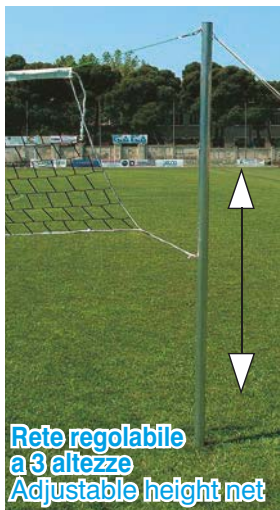

Art. 014
Kit Calcio Tennis pali in alluminio sezione mm. 60 completo di rete mt. 9,85 regolabile a 3 altezze (cm. 110/170/230) con tiranti, picchetti e nastro di delimitazione, utilizzabile solo su terreni naturali
Soccer Tennis Kit aluminium poles 60 mm. with 9,85 meter net adjustable at 3 different heights, tightening ropes, pegs and tape for bounds for natural grass



Art. 014



Art. NS200

pg.29

Rotolo nastro stradale bianco/rosso mt. 200 (compreso nei kit Art. 013 e Art. 014)
Red/White Tape length 200 meters (supplied with kit Art. 013 and Art. 014)



Art. 013.N
Kit Calcio Tennis pali in PVC
completo di rete mt. 3,30
tiranti e picchetti
per terreni naturali
Soccer Tennis Kit PVC poles
with 3,30 meter net
tightening ropes and pegs
for natural grass

pg.5



Art. 013.G Kit calcio tennis pali in PVC
con rete mt.10 - altezza cm.130
con tiranti, picchetti e sacca
per terreni naturali
Soccer Tennis Kit PVC poles
10 meter long 130 cm. height net with
ropes, steel hooks and bag
for natural grass



pg.5



Art. 013.P
Kit calcio tennis
con rete mt. 3
utilizzabile anche
su terreni sintetici
o indoor
con sacca
Soccer Tennis Kit
3 meter net - with bag
also for artificial
grass or indoor

Art. 013.SP

**Kit calcio tennis con rete cm.
450x170
utilizzabile anche
su terreni sintetici o indoor**

con sacca
Soccer Tennis Kit 4,5x1,7 meter net
with bag, also for artificial grass
or indoor

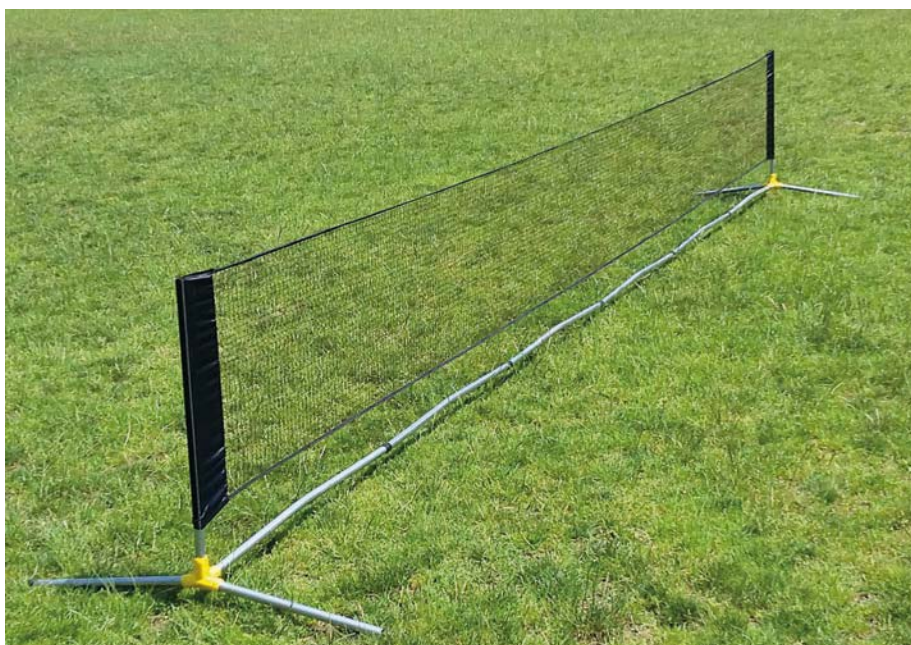

● pg.6

Art. 013.60

**Kit calcio tennis
con rete cm. 600x90
utilizzabile anche
su terreni sintetici
o indoor con sacca**

Soccer Tennis Kit
6,0x0,9 meter net
with bag, also
for artificial grass
or indoor



Art. 013.S

**Kit Calcio Tennis TATTICO
pali in polipropilene
completo di rete in PVC mt. 2,30 regolabile in
altezza, tiranti e basi in ferro verniciato
utilizzabile anche su terreni sintetici o indoor**

Soccer Tennis Kit polypropylene poles
with adjustable height PVC net 2,30 meter long,
tightening ropes and painted steel bases
also for artificial grass or indoor

**Nasconde per qualche istante la visione
del pallone, determinando risposte a livello
neuromuscolare e migliorando cinestesia e
sensibilità nel tocco di palla**

This Soccer Tennis Kit hides the ball from
player's visibility stimulating neuro muscular
reflexes and improving ball control

● pg.6



Art. 013.SB

**Borsa per Kit calcio tennis
Art. 013.S**

Bag to carry soccer tennis
kit Art. 013.S



ARCHI DI PRECISIONE - Precision passing arcs

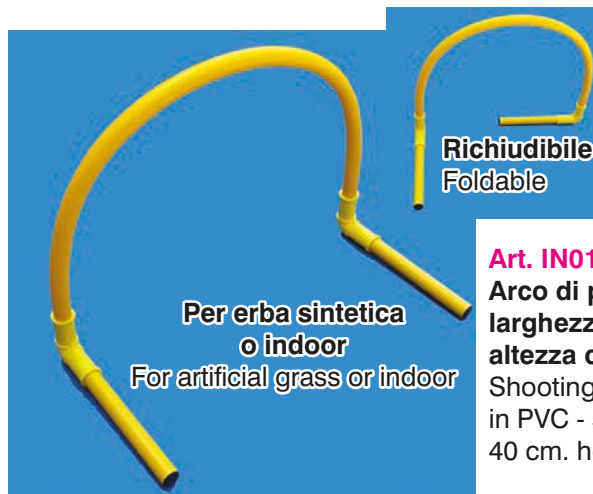
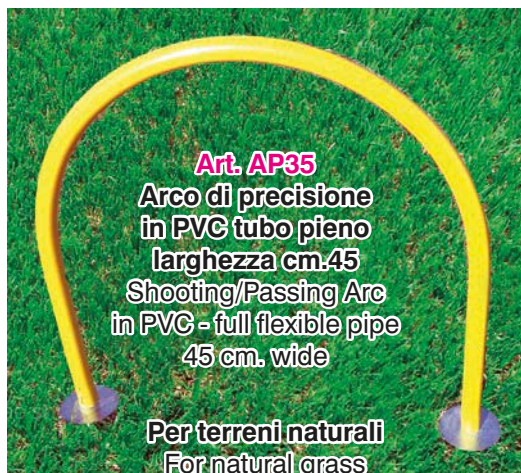

pg.5

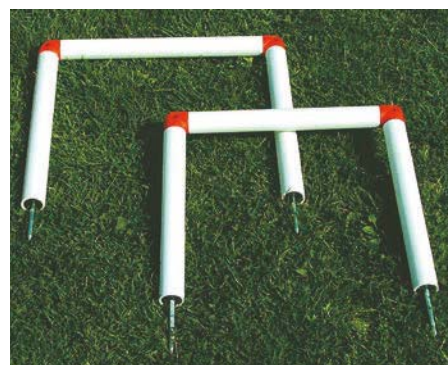

Art. 020 / 021 / 022
Arco di precisione in polipropilene
Ø 40 mm. cm. 45x45 / 40x40 / 35x35
Shooting/Passing Arc
in polypropylene Ø 40 mm.
dim. 45x45 / 40x40 / 35x35 cm.



Art. A020 / A021 / A022
Arco di precisione
in alluminio Ø 32 mm.
cm. 45x45 / 40x40 / 35x35
Shooting/Passing Arc
in aluminium Ø 32 mm.
dim. 45x45 / 40x40 / 35x35 cm.



FORCHE - Heading Trellises



Art. F203

pg.6

Art. F203

Forca doppia
in ferro verniciato
telescopica, smontabile
bussola inclusa

altezza da terra cm. 300
(palloni esclusi)

Double Heading Trellis
in painted iron

telescopic, dismountable,
underground socket included,
height 300 cm. off ground
(balls not included)



Art. 039.4 / 039.5

**Pallone per
forca in pelle sintetica
disponibile mis. 4 e 5**
Ball for Heading Trellis,
in synthetic leather
available size 4 and 5



pg.6

Art. 037F

**Forca singola
in acciaio zincato,
con zavorra,
per erba sintetica o indoor
altezza da terra cm.300
(pallone escluso)**

Single Heading Trellis
in galvanized iron weighted for
artificial grass or indoor
height 300 cm. off ground
(ball not included)



Art. ULTVE5

**Pallone per forca
Trial n. 5**

**in gomma
doppio strato
gr. 420**

Ø cm. 21,5
Trial rubber Ball
for Heading trellis
size 5
double stratum

Art. ULTVE4

Pallone per forca Trial n. 4

in gomma doppio strato gr. 250 Ø cm. 20

Trial rubber Ball for Heading trellis size 4 double stratum



Art. 038
Forca doppia
in alluminio
tubo sezione 60 mm.
altezza da terra cm.300
(palloni esclusi)
 Double Heading Trellis
 in aluminium
 pipe section 60 mm.
 300 cm. height off ground
 (balls not included)

Art. B038
Bussola per forca
Art. 038 (optional)
 Underground socket
 for Art. 038 (optional)



Art. ACTP40
Attrezzo per l'allenamento
al colpo di testa
applicabile a porte di qualsiasi tipo
per mezzo di fettucce elastiche,
in PVC Ø mm. 40
(pallone escluso)
 Header training tool
 to be easily applied to goals of any type
 by means of elastic tapes,
 PVC pipe Ø 40 mm.
 (ball not included)



Con questo attrezzo
è possibile verificare
giornalmente i
miglioramenti
nell'elevazione
degli atleti
 This instrument tests
 players' daily jump
 improvements

Art. HJT Head Jump Tester - strumento polivalente di misurazione
ed allenamento, permette la valutazione delle qualità muscolari
degli arti inferiori, dell'elevazione dei giocatori, del loro modo di
colpire la palla di testa e dell'ampiezza del tuffo del portiere
 Instrument that allows the training and measurement of jump ability of
 players and goalkeepers

BARRIERE SPECIALI - GK TRAINING



Video dimostrativo disponibile
su www.barretsport.com
Video available on
www.barretsport.com

La palla passa
attraverso le
finestre senza
perdere velocità

Telo cm.250x173
250x173 cm. sheet

Ball goes through the windows without
losing speed

Art. 003WB
BARRIERA CON FINESTRE
per l'allenamento ai calci
di punizione e per il
miglioramento dei tempi
di reazione del portiere in
caso di tiri improvvisi
kit completo
WINDOW BARRIER for
free kicks and Goalkeeper
training to fast and sudden
shots **complete kit**

pg.1

Art. 003WBS
**STRUTTURA
SUPERIORE**
barriera con
finestre, applicabile
al carrello porta
sagome Art. 003
Window Barrier
UPPER PART
to be fixed upon
trolley Art. 003



Art. 003RX
**BARRIERA FILTRANTE
REFLEX kit completo**
REFLEX FILTERING
BARRIER on wheels -
complete kit



**Nuovo sistema
di fissaggio**
New more
resistant elastics
and hooks

pg.1

Art. 003RXS
**STRUTTURA
SUPERIORE** barriera
filtrante REFLEX,
applicabile al carrello
porta sagome Art. 003
Reflex Filtering Barrier
UPPER PART
to be fixed upon
trolley Art. 003



Art. 003RXS

Art. 003

**INNOVATIVO ATTREZZO FONDAMENTALE PER
L'ALLENAMENTO DEI RIFLESSI DEL PORTIERE.
LA PALLA (INVISIBILE PER IL PORTIERE AL
MOMENTO DEL CALCIO) FILTRA ATTRAVERSO
LE STRISCE ED ARRIVA IN PORTA
ALL'IMPROVISO ASSUMENDO TALVOLTA
TRAJETTORIE IMPREVEDIBILI.**

**ATTREZZO DA POSIZIONARE IN PROSSIMITÀ
DELL'AREA PICCOLA**

**A revolutionary device for goalkeeper's reflex
training.
The goalkeeper cannot see the ball until it
passes through the stripes. The direction of the
ball is often unpredictable!**

To be placed not too far from goalkeeper's area



**L'ATTREZZO PUO' INOLTRE ESSERE UTILIZZATO COME UNA
COMUNE BARRIERA PER L'ALLENAMENTO DEI CALCI DI
PUNIZIONE**

**It is also very useful for free kick practising for both kicker and
goalkeeper!**



MURI - TELAI CON RETE - Rebounders - Iron frames with nets



Art. 5011

**Muro per allenamento portieri in vetroresina
montato su telaio con 4 ruote**
Fiberglass Goalkeeper Rebounder
mounted on frame with
4 wheels

pg.6

Dimensioni:
altezza cm.200
larghezza cm.130
profondità cm.80
peso Kg.100

Dimensions:
height 200 cm.
width 130 cm.
depth 80 cm.
weight 100 Kg.

**Calciando o lanciando la palla
verso il muro essa assumerà
direzioni di rimbalzo
imprevedibili, favorendo
l'allenamento dei riflessi
del portiere**

By kicking or throwing the ball
against the wall it will rebound in
different directions,
testing and training GK's reflexes



**Zavorra
in cemento
inclusa**
Concrete
ballast
included

**Consente l'allenamento con
o senza il preparatore atletico**
Goalkeeper can exercise
by himself as well



**Con superficie superiore a semisfere
e superficie inferiore liscia**
Upper side with hemispheres
and smooth lower side

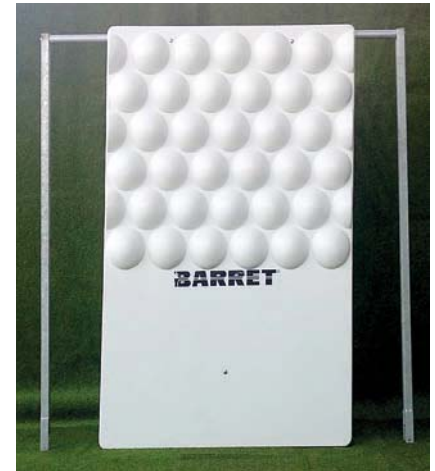

Art. 5012SC
Muro per allenamento portieri in vetroresina cm. 200x130
installato su carrello in acciaio zincato con ruote
 Fiberglass Goalkeeper rebounder 200x130 cm. installed on a
 galvanized steel trolley with wheels

Art. KMC3S
Kit superiore muro allenamento
portieri per adattamento a carrello
Art. NCP3S oppure Art. 003
 Rebounder kit upper part to be fixed
 upon trolley Art. NCP3S or Art. 003

Rimuovendo il pannello in vetroresina ed eventualmente il telaio di sostegno, si può utilizzare il carrello porta 3 sagome Art. NCP3S

By removing the fiberglass panel and the support frame, you can use the trolley for carrying 3 mannequins Art. NCP3S



Art. PVLSC
Pannello in vetroresina con superficie superiore a semisfere e superficie inferiore liscia, munito di ganci e staffa per ancoraggio - dimensioni cm. 200x130
Può essere acquistato separatamente ed installato facilmente sulla Barriera Filtrante Reflex Art. 003RX oppure sulla Barriera con Finestre Art. 003WB
 Fiberglass panel with upper hemisphere surface and lower smooth surface, equipped with hooks and anchor bracket - size 200x130 cm. It can be purchased separately and easily installed both on the Reflex Filtering Barrier Art. 003RX and on the Window Barrier Art. 003WB



Kg. 50



Art. 5010

Muro per allenamento giocatori a 3 facce in vetroresina montato su telaio con 3 ruote

3 side Fiberglass Players' Rebounder mounted on frame with 3 wheels
Dimensions: 1,3 m. width x 1,1 m. height every side weight 50 Kg.



pg.6



Art. 5050

Muro per allenamento giocatori a 2 facce di cui una ad inclinazione regolabile, interamente in vetroresina montato su telaio con 4 ruote
2 side Fiberglass Players' Rebounder mounted on frame with 4 wheels one side can be inclined

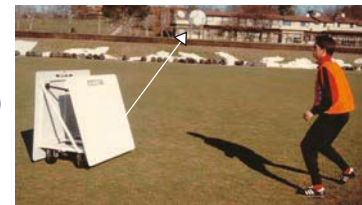
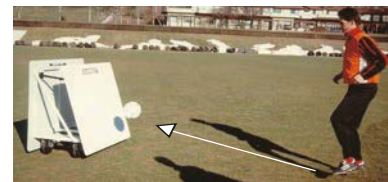

Kg. 50



Dimensioni:

m. 1,3 larghezza x m. 1,1 altezza ciascuna faccia

peso Kg. 50

Dimensions:

1,3 m. width x 1,1 m. height every side

weight 50 Kg.

Attraverso l'utilizzo della parete ad inclinazione regolabile è possibile determinare traiettorie di risposta della palla verso l'alto al fine di sollecitare il tiro al volo, il colpo di testa ed il controllo di palla
Thanks to the adjustable inclination you can get an upward ball rebound and train acrobatic shooting, headers and ball control

Art. MP501N

**Muro prismatico in vetroresina a 3 facce lisce di dimensioni
cm.107x140 - cm.107x120 - cm.107x108 - peso Kg.48 - con asole per il trasporto
utilizzabile contemporaneamente da 2 lati ed in 4 diverse posizioni**

3 side Fiberglass Players' Rebounder with side dimensions
107x140 cm. - 107x120 cm. - 107x108 cm. weight 48 Kg. with slots for transport
****allows 4 different training positions on both sides simultaneously****

pg.6



Permette di ottenere la più ampia
varietà di rimbalzi e traiettorie, utili
per il miglioramento del controllo di
palla, del passaggio, del tiro a volo
e del colpo di testa

1

**Posizione "in piedi" con 3 facce
perpendicolari al terreno di gioco**
Standing position with all sides
perpendicular to the ground



2

**Posizione con base a terra cm.107x108
Allenamento con superfici di rimbalzo
ad inclinazione alta e medio-alta**
Position with 107x108 cm. base
Training with high and medium inclination
rebounding sides

Allows the widest
variety of rebounds in
order to improve ball
control, passing and
shooting



3

**Posizione con base a terra
cm.107x120
Allenamento con superfici
di rimbalzo ad
inclinazione alta e bassa**
Position with 107x120 cm. base
Training with high and low
inclination rebounding sides



**Rinforzo interno
per l'ottimizzazione del rimbalzo**
Internal reinforcement for rebound improvement

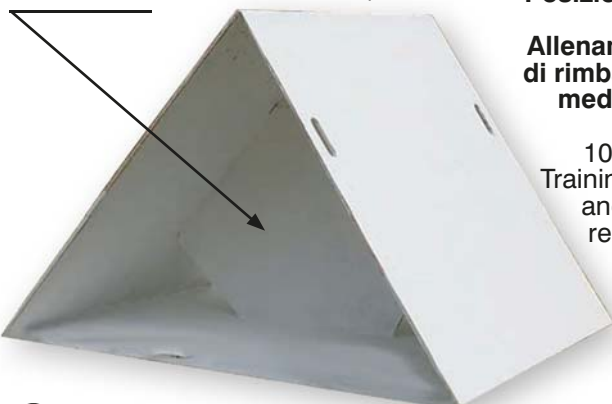

4

**Posizione con base a terra
cm.107x140
Allenamento con superfici
di rimbalzo ad inclinazione
medio-bassa e bassa**
Position with
107x140 cm. base
Training with medium-low
and low inclination
rebounding sides



Art. PLRB16

**Muro prismatico in vetroresina a 3 facce lisce
larghezza cm.130 - altezza massima cm.65
con asole per il trasporto - peso kg.24**

****utilizzabile contemporaneamente da 2 lati ed in 3 diverse posizioni****

3 side Fiberglass Players' Rebounder
width 130 cm. - maximum height 65 cm.
with slots for transport - 24 kg. weight

****allows 3 different training positions on both sides simultaneously****

pg.6

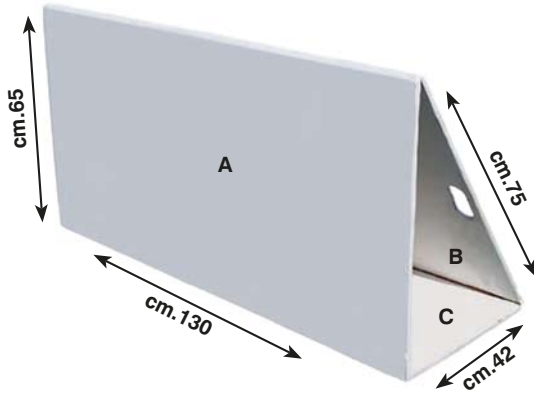

1

**Posizione con superficie A perpendicolare
al terreno e superficie B molto inclinata**
Position with 90 degrees A side and high inclination B side

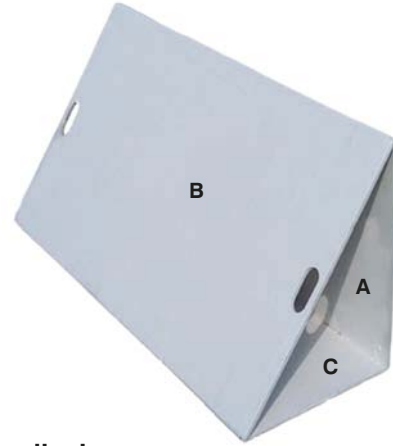

**Video dimostrativo disponibile
su www.barretsport.com**

Video available on
www.barretsport.com

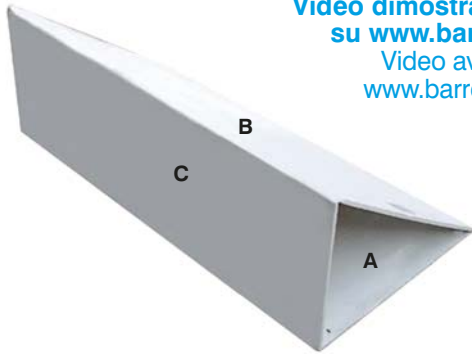

2

**Posizione con superficie C perpendicolare
al terreno e superficie B inclinata**
Position with 90 degrees C side and low inclination B side

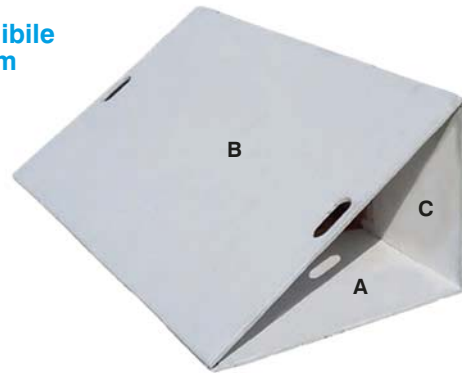

**Si consiglia di utilizzare una
zavorra all'interno dell'attrezzo
per conferire maggiore stabilità**
It is recommended to place a
weight inside for great stability

3

**Posizione con superfici A e C
a diversa inclinazione**
Position with A and C sides differently inclined

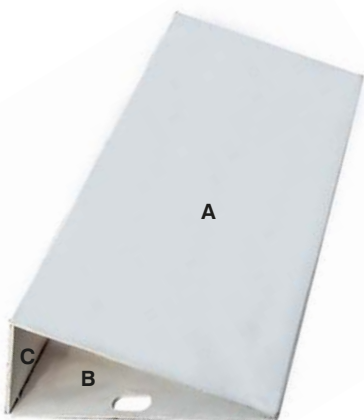

**Permette di ottenere la più ampia
varietà di rimbalzi e traiettorie, utili
per il miglioramento del controllo di
palla, del passaggio, del tiro a volo
e del colpo di testa**

**Rinforzo interno
per l'ottimizzazione del rimbalzo**
Internal reinforcement for rebound improvement

**Allows the widest
variety of rebounds in
order to improve ball
control, passing and
shooting**



pg.7

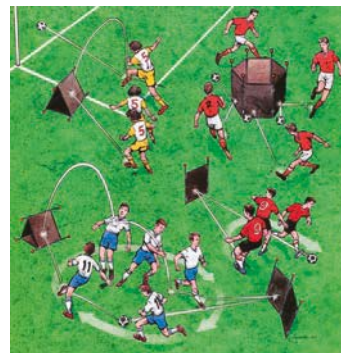

Ideale per l'effettuazione di esercizi individuali e di gruppo volti al miglioramento della coordinazione motoria, del controllo di palla, del passaggio, del tiro e del gioco aereo
 Very useful for individual and group exercises to improve coordination, ball control, passing and shooting

Art. PAL PAL ORIGINAL - Kit 3 pannelli orientabili in legno finlandese trattato a 5 strati rivestiti in gomma, completo di 4 aste metalliche di fissaggio, 6 pomelli di sicurezza e 1 martello per il fissaggio

Pal Original - Kit 3 rebounding sides in Finnish multi stratum wood covered with rubber, with 4 metal pegs, 6 safety protections and 1 hammer



pg.6

Art. TM001

Muro triangolare in legno multistrato marino, trattato con vernice impermeabilizzante dimensioni lato cm.150x50

Attraverso l'uso in posizione verticale è possibile determinare traiettorie di risposta della palla verso l'alto al fine di sollecitare il tiro a volo, il colpo di testa e lo stop

Triangular rebounder made of marine wood treated with special paint against humidity - side size 150x50 cm. By placing it in vertical position you will receive an upward ball rebound to train acrobatic shooting, header and ball control.



pg.7

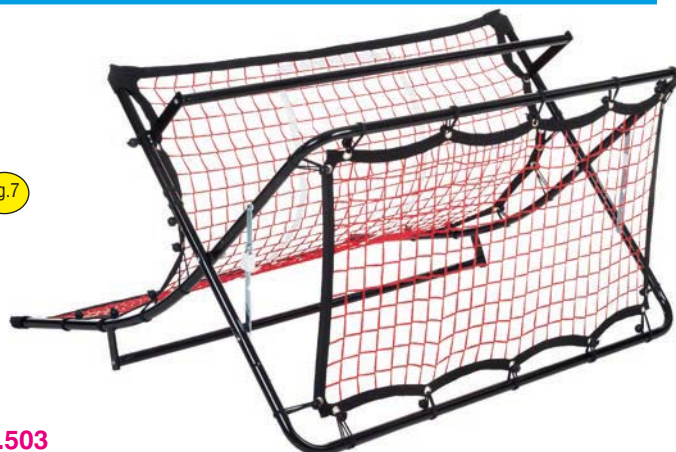

Art. PTI.503

Telaio con rete in acciaio verniciato, bifacciale ricurvo su un lato - inclinazione regolabile dim. cm. 111x105x63
 2 face adjustable inclination iron frame with net for goalkeepers and players size 111x105x63 cm.



Art. SCVR16

Disco in vetroresina con maniglie per l'allenamento della reattività del portiere sulle deviazioni da tiro o colpo di testa ravvicinato diametro cm.47 peso kg.2

Fiberglass Discus with handles

for close shot and deflection GK training - diameter 47 cm. weight 2 kg.

pg.7



Art. 5030.T

Telaio con rete in alluminio dim. cm.90x70 ad inclinazione regolabile con maniglie impugnabili dal preparatore.

Consente la simulazione di colpi di testa e tiri acrobatici per un allenamento alternativo del portiere

Aluminium frame with net size 90x70 cm. adjustable inclination with handles for trainer to simulate headers and acrobatic shooting trajectories for new GK exercises



New!

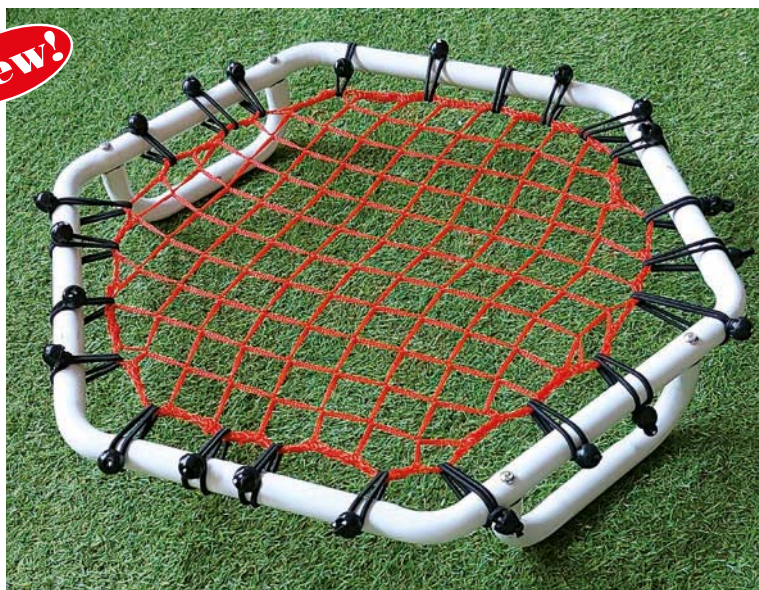

Art. PTI.5858

Telaio con rete esagonale in metallo verniciato dim. cm.65x58 con maniglie impugnabili dal preparatore.

Consente la simulazione di colpi di testa e tiri acrobatici per un allenamento alternativo del portiere

Hexagonal metal frame with net size 65x58 cm. with handles for trainer to simulate headers and acrobatic shooting trajectories for new GK exercises



Art. 5030
Telaio con rete cm. 130 x 130
in ferro verniciato
ad inclinazione regolabile
Painted iron frame with net,
dimensions 130x130 cm.
adjustable inclination

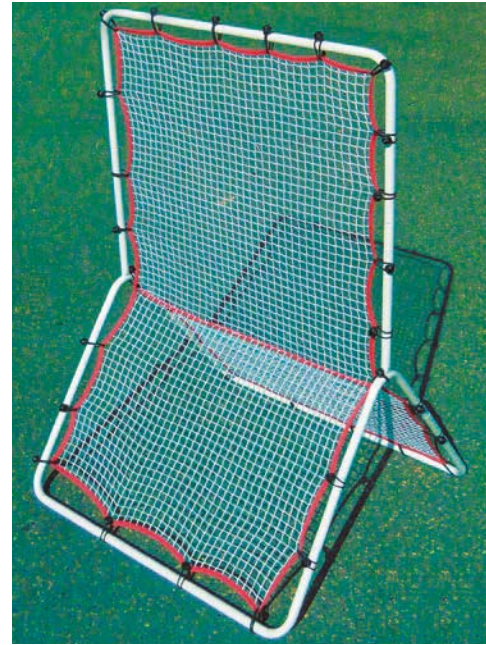

Art. 503.BF
Telaio con rete in ferro verniciato, bifacciale
a doppia inclinazione, altezza cm.150 larghezza
cm.100 con picchetti per fissaggio a terra,
per allenamento portieri e giocatori
Iron frame with net, in painted iron 2 sides double
inclination height 150 cm. width 100 cm. with anchoring
hooks for goalkeepers and players

pg.7

Art. 5035G Telaio con rete cm.105 x 105 in ferro cromato ad
inclinazione regolabile, per allenamento portieri e giocatori
Iron frame with net in chromed iron dimensions 105x105 cm.
adjustable inclination for goalkeepers and players

**Prodotto professionale
in ferro cromato**
Professional in
chromed iron



**Prodotto professionale
in ferro zincato**
Professional in
galvanized iron

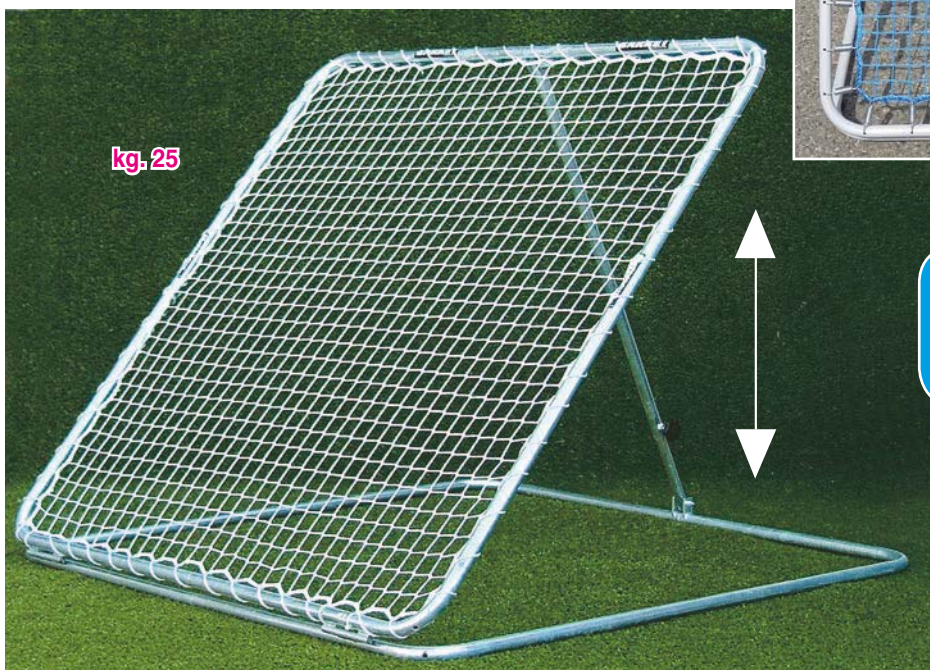

Art. 5040
Telaio con rete cm. 140 x 140
in ferro zincato ad inclinazione
regolabile, per allenamento
portieri e giocatori
Iron frame with net in galvanized
iron dimensions 140x140 cm.
adjustable inclination
for goalkeepers and players



Art. 50.220
Telaio con rete
cm. 220 x 180
in ferro zincato
ad inclinazione regolabile,
per allenamento
portieri e giocatori
Iron frame with net in
galvanized iron dimensions
220x180 cm.
adjustable inclination
for goalkeepers
and players

● pg.7

Prodotti professionali
in ferro zincato
Professional in
galvanized iron



Art. 5041
Telaio con rete cm. 315 x 230
in ferro zincato ad inclinazione regolabile,
per allenamento portieri e giocatori
Iron frame with net, in galvanized iron
dimensions 315x230 cm.
adjustable inclination
for goalkeepers and players

kg. 75



New!



Art. ST441

Set 4 ruote con staffa per un agevole
trasporto del telaio Art. 5041 (optional)
Set of 4 wheels with bracket for Art. 5041 (optional)





Video dimostrativo disponibile su www.barretsport.com
Video available on www.barretsport.com

Art. DT01
Deviatore di traiettoria
Tubi in alluminio, con cerniere e piedini di stabilità.
Coadiuvano l'allenamento quotidiano del portiere ed il suo eventuale recupero post traumatico
BREVETTATO
SHOT DEVIATOR - pipes in aluminium, with hinges and stability pegs - very useful to improve GK reactivity and to accelerate injury recovery
PATENTED

Brevettato
Patented

● pg.6

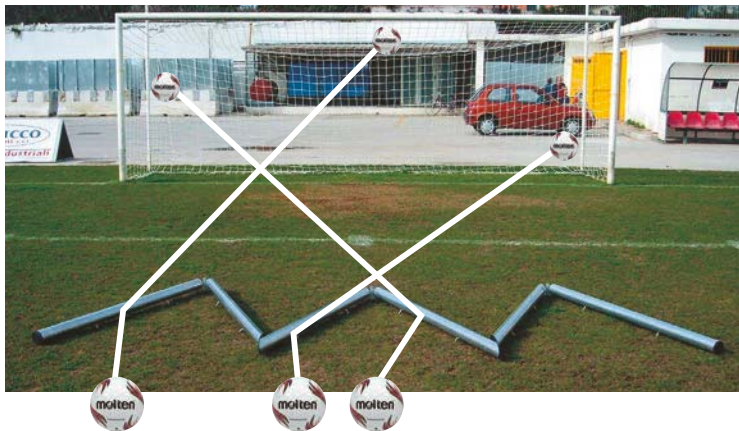

Borsa per il trasporto inclusa
Bag included

Si consiglia di inumidire l'erba di fronte all'attrezzo per incrementare la velocità della palla calciata rasoterra prima dell'impatto con il Deviatore
We recommend to wet the grass in front of the training device in order to let the ball hit the deviator at a higher speed



Video dimostrativo disponibile su www.barretsport.com
Video available on www.barretsport.com

Art. BP63
BALL PLAYNING Modello Mundial - telo in PVC con rilievi gonfiabili e riempiibili con acqua per l'allenamento dei riflessi del portiere metri 5 x 2,5 - completo di borsa e pompa per la gonfiatura

Ball Playning Mundial for GK training in PVC size 5 x 2,5 meters with air and water bubbles, complete with pump and bag



● pg.6

Prodotto ideato e brevettato da Mario Quaglieri, preparatore portieri professionista



Bagna il Ball Playning prima dell'uso per incrementare la velocità della palla!
Always wet your Ball Playning to increase ball speed!



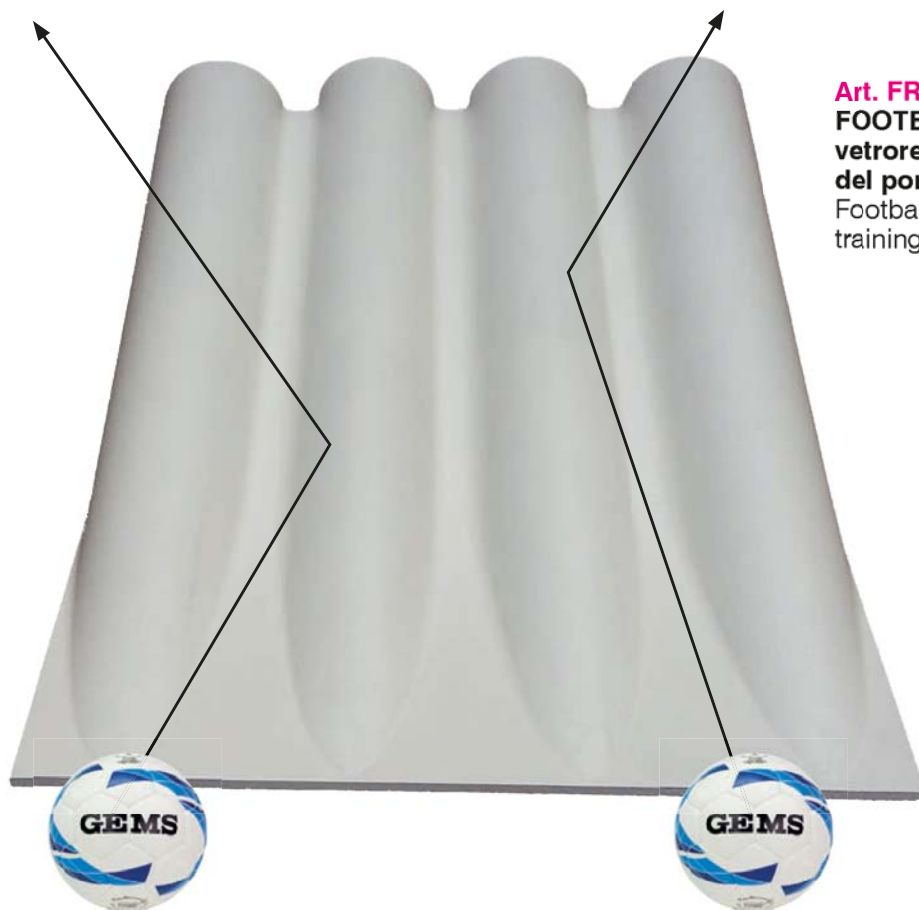

Art. FRM16
FOOTBALL RAMP - attrezzo in vetroresina per l'allenamento dei riflessi del portiere sui tiri ravvicinati e deviati
Football Ramp - fiberglass deviator for GK training to close highly deflected shots

Bagna il Football Ramp prima dell'uso per incrementare la velocità della palla!
Always wet your Football Ramp to increase ball speed!

pg.6

dimensioni: cm.150x110 ad inclinazione regolabile per mezzo di due piedi telescopici
dimensions: 150x110 cm. adjustable inclination by means of two telescopic feet



Video dimostrativo disponibile su www.barretsport.com
Video available on www.barretsport.com

pg.6

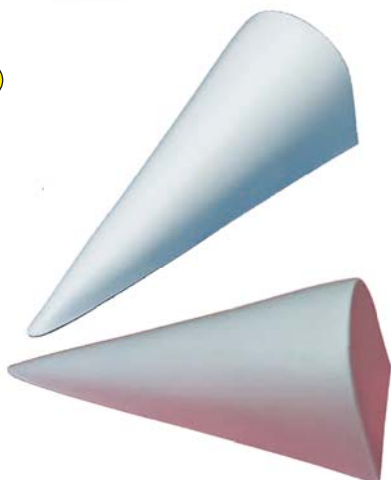

Art. BDV15
Cuspide in vetroresina appesantito con cemento, dimensioni cm.56x21x21h per allenamento dei riflessi del portiere
Fiberglass cusp with concrete filling dimensions 56x21x21 cm. for GK training

Posizionando una serie di cuspidi nell'area piccola si ottengono deviazioni della palla improvvise, utili per l'allenamento dei riflessi e della reattività del portiere
Train goalkeeper's reactivity to sudden and close deflections by placing a number of cusps near the GK's area



Art. FRA
FOOTBALL RACK - attrezzo in ferro zincato per l'allenamento dei riflessi del portiere sui tiri ravvicinati e deviati
 dimensioni cm.160x54 - peso kg. 13
 Football Rack - galvanized iron deviator for training of GK reflexes on close and deflected shots
 size 160x54 cm. - weight 13 kg.

Video dimostrativo disponibile su www.barretsport.com
 Video available on www.barretsport.com

pg.6



Art. FW18
FOOTBALL WAVE - attrezzo in policarbonato per l'allenamento dei riflessi del portiere sui tiri ravvicinati e deviati
 dimensioni cm. 90x60 - peso kg. 5
 Football Wave - polycarbonate deviator for training of GK reflexes on close and deflected shots
 size 90x60 cm. - weight 5 kg.



Bagna il Football Wave prima dell'uso per incrementare la velocità della palla!
 Always wet your Football Wave to increase ball speed!

Più Football Waves possono essere posizionati contemporaneamente sul terreno per ottenere effetti imprevedibili
 You can place more than one Football Wave on the pitch to get unpredictable deflections

Inclinazione regolabile per mezzo di due piedi telescopici
 Adjustable inclination by means of two telescopic feet



PROPRIOCEZIONE - Equilibrium training



Art. 168PC

Art. 168PC
Tavoletta propriocettiva in plastica su emisfera, Ø cm. 41 regolabile in altezza
 Plastic Equilibrium Board with hemisphere bottom side Ø 41 cm. adjustable height



Art. 168PC

pg.7

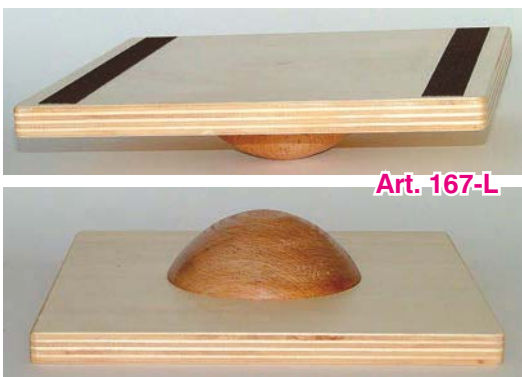

Art. 167-L

Art. 167-L Tavoletta propriocettiva in legno su emisfera, base di appoggio cm. 30x30
 Wooden Equilibrium Board with hemisphere bottom side, base 30x30 cm.



Art. IS441
Tavoletta propriocettiva in legno su emisfera, con rivestimento antiscivolo Ø cm. 40
 Wooden Equilibrium Board with hemisphere bottom side, Ø 40 cm. base with anti-skid surface



Art. 169-R

Art. 169-R Tavoletta propriocettiva in legno su semiluna, base di appoggio cm.60x40 con rivestimento in gomma antiscivolo
 Wooden Equilibrium Board, with half moon bottom side, base dimensions cm.60x40 with anti-skid surface

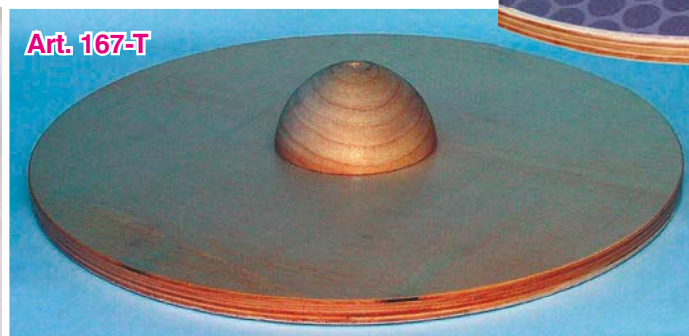

Art. 167-T

Art. 167-T Tavoletta propriocettiva in legno su emisfera, Ø base di appoggio cm. 60 con rivestimento in gomma antiscivolo
 Wooden Equilibrium Board with hemisphere bottom side, base Ø 60 cm. with anti-skid surface



Art. 169-V Tavoletta propriocettiva in vetroresina su semiluna, base di appoggio cm.60x40
 Fiberglass Equilibrium Board, with half moon bottom side, base dimensions 60x40 cm.



Art. 167-V Tavoletta propriocettiva in vetroresina su emisfera, Ø base di appoggio cm. 60
 Fiberglass Equilibrium Board with hemisphere bottom side, base Ø 60 cm.



Velcro
Velcro

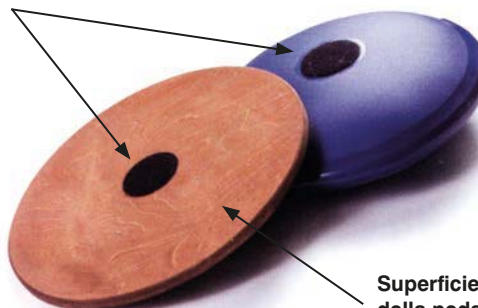

Superficie inferiore
della pedana in legno
Lower surface of the
wooden platform

Art. 995201 PROPRIO FOOT
Tavoletta propriocettiva in legno situata
su una superficie di appoggio gonfiabile
Wooden Equilibrium Board
with inflatable bottom side

pg.7



Art. 995243 ROLA BOLA Tavola per l'allenamento dell'equilibrio
con superficie antiscivolo - i fermi di sicurezza impediscono al cilindro di scivolare all'esterno
Wooden Equilibrium Board with anti-skid on top
The cylinder never slips out of the board thanks to the security wood pieces on bottom side

pg.7



Art. AIR.OC
Air step gonfiabile completo
di maniglie con elastici
(ad esaurimento scorte)
Inflatable Air Step
handles and elastics included
(until available in stock)



Art. TBEFS
BLOCCO PER STRETCHING tendineo e muscolare
(flessori caviglia e coscia, dorso etc.)
con appoggio soffice e sagomato a 2 inclinazioni
ideale per il defaticamento e per il recupero
STRETCHING BLOCK for ankle, leg, back muscles and
tendons - with soft double inclination
very good for after-training exercises

pg.8



Art. MH9T / MH16T Semisfera gonfiabile Trial per riabilitazione e stimolazione propriocettiva diam. cm. 9 o cm. 16
Inflatable hemisphere for rehabilitation Ø 9 or 16 cm.



Art. FTN-DB
Cuscino gonfiabile puntinato Ø cm 32,5
Inflatable cylinder for rehabilitation Ø 32,5 cm.



Art. FY8911
Cuscino gonfiabile puntinato Ø cm 39
Inflatable cylinder for rehabilitation Ø 39 cm.

pg.7



Art. C1
Pedana Cilindrica gonfiabile Trial Skimmy per riabilitazione e stimolazione propriocettiva dim. cm.32,5x6
Inflatable cylinder for rehabilitation dim. 32,5x6 cm.



Art. C2
Pedana Cilindrica gonfiabile Trial Super Skimmy per riabilitazione e stimolazione propriocettiva, dim. cm.40x9
Inflatable cylinder for rehabilitation dim. 40x9 cm.



Resistenti ai tacchetti
Stud proof



Art. C3
Pedana Trial Super Skimmy Professional con spalla rinforzata per riabilitazione e stimolazione propriocettiva, gonfiabile cm.40x9
Inflatable cylinder 40x9 cm. reinforced on sides

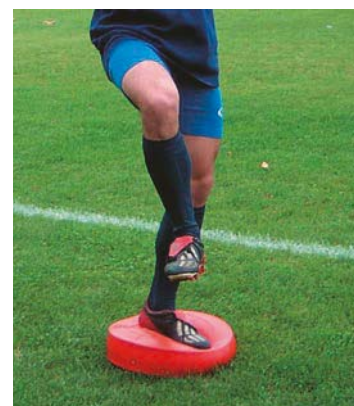



Art. C11
Pedana Rotante 1
 dim. cm 32,5x6
 kg 2,8
 (inclusa pompetta
 per la gonfiatura)
 Rotatory disk 1
 pump included



Art. C22
Pedana Rotante 2
 dim. cm 40x10
 kg 4
 (inclusa pompetta
 per la gonfiatura)
 Rotatory disk 2
 pump included



Le Pedane Rotanti Trial, grazie al particolare meccanismo rotante, consentono di creare un'infinita varietà di esercizi basati su diverse posizioni di appoggio e modalità di movimento, utili a stimolare contemporaneamente il sistema vestibolare e quello visivo sensoriale, agendo quindi su tutti i sistemi di controllo del movimento sia a livello nervoso centrale che su quello spinale medio e periferico

Rotatory Proprioceptive Disks Trial, given the particular rotating mechanism, allow a great variety of exercises based on different positions and motions, useful to simultaneously stimulate the vestibular and the sensory visual systems at both central and spinal/peripheral nervous levels

pg.7

Art. C4
Rebound Disk - diametro cm.40
altezza cm.4 - Kg.1,5 colore rosso
 40 cm. diameter - 4 cm. thick - 1,5 Kg.

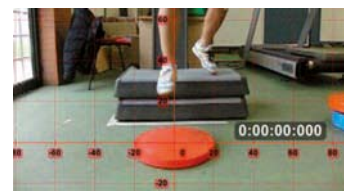

Rebound Disk Trial è una nuova pedana ideale per allenare contemporaneamente la forza muscolare e la propriocezione. È adatta sia all'uso indoor che outdoor, anche con scarpe tecniche munite di tacchetti. In particolare, con Rebound Disk è possibile sfruttare l'altezza per effettuare esercizi combinati pliometrici (cadute ed ammortizzamento con e senza rimbalzo) e propriocettivi, consentendo all'utente un'esperienza coordinativa e di potenziamento neuromuscolare notevole. Il salto, così come la corsa, è un elemento fondamentale in moltissimi sport come calcio, pallamano, beach-handball, basket, volley, e Rebound Disk è particolarmente allenante per il salto con arresto e cambio di direzione

Rebound Disk Trial is a new tool ideal to simultaneously train muscle strength and proprioception. It's suitable both for indoor and outdoor utilization, even with technical shoes (with studs). In particular, with Rebound Disk it's possible to exploit one's height for plyometric exercises (fall and dampen with or without rebound) and for proprioceptive ones, and the user is enabled to experience a remarkable coordination and neuromuscular strengthening. Jumping, as well as running, is a basic element in many sports such as soccer, handball, beach-handball, basketball, volleyball, and Rebound Disk is very effective in training jump with stop and direction changes

**Art. T1 Medusa Trial - struttura instabile base Ø cm. 45
 altezza cm. 23 per riabilitazione e stimolazione
 equilibrio, in gomma doppio strato
 massima instabilità**
 Medusa for rehabilitation
 and equilibrium training
 double stratum rubber
 Ø 45 cm. base
 height 23 cm.

**Resistente
 ai tacchetti
 Stud proof**

pg.8



**Resistente ai
 tacchetti
 Stud proof**

**Art. T3
 Pedana instabile
 con base inferiore
 antiscivolo
 Ø cm. 55
 altezza cm. 15
 studiata per
 i campi sintetici,
 specifica per
 i più giovani**
 Unstable Medusa
 with anti-skid bottom
 55 cm. Ø base
 height 15 cm.
 ideal for artificial
 grass and young
 players

pg.8

**Art. T1.1
 Medusa Trial Ø cm.45
 altezza cm. 23
 con piatto rigido
 alla base
 per conferire
 maggiore stabilità**
 Medusa 45 cm. Ø base
 height 23 cm.
 with rigid bottom for
 better stability



**Resistente
 ai tacchetti
 Stud proof**

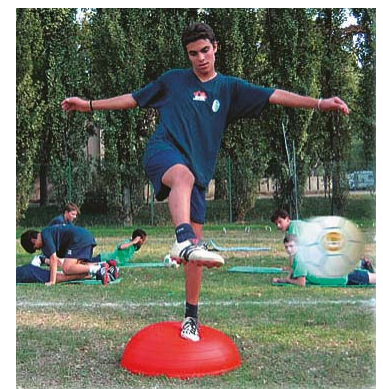

pg.8

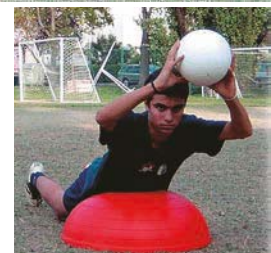

**Art. T2 Tartaruga Trial - struttura instabile base Ø cm. 65 altezza cm. 24
 per riabilitazione e stimolazione equilibrio, in gomma doppio strato**
 Medusa double stratum rubber Ø 65 cm. base height 24 cm. - for rehabilitation and equilibrium training



pg.7

Art. AHF-170

Pedana BOSU Ø cm.63 - h. cm.22
ideale per fitness, yoga, pilates
(fino ad esaurimento scorte)
 Bosu ball Ø 63 cm. - h. 22 cm.
 ideal for fitness, yoga, pilates
 (until available)



Art. BOS

Pedana BOSU Ø cm.59 - h. cm.26
ideale per fitness, yoga, pilates
completa di elastici con maniglie e pompa
 Bosu ball Ø 59 cm. - h. 26 cm.
 ideal for fitness, yoga, pilates
 complete with rubber bands with handles and pump



pg.8



Art. 14181

Fettuccia con lunghezza 18 metri per l'allenamento dell'equilibrio. Si fissa facilmente tra due alberi, ed è perfetta per giocare, allenarsi o fare riabilitazione. Kit completo con sacca e paraalberi
 18 meter long tape for balance training. It is easily fixed between two trees and is perfect for playing, training or rehab. Complete kit with bag and tree protections



pg.8



Art. TCRAZY/TCR.T2
CRAZY HORSE
per allenamento di equilibrio "estremo"
da effettuarsi in coppia
 For extreme balance training

Art. TA-I Coppia tappeti propriocettivi ad isole a 2 densità diverse:

1 tappeto densità gr. 120 con isole densità gr. 30 - 1 tappeto densità gr. 30 con isole densità gr. 120
dimensioni tappeti m.2x1 modulabili con velcro (a formare 1 materasso m.4x1 o m.2x2)

Pair of Mats 2x1 meter each (when together 4x1 or 2x2 meter):

1 mat 120 gr. density with 30 gr. density round areas, 1 mat 30 gr. density with 120 gr. density round areas

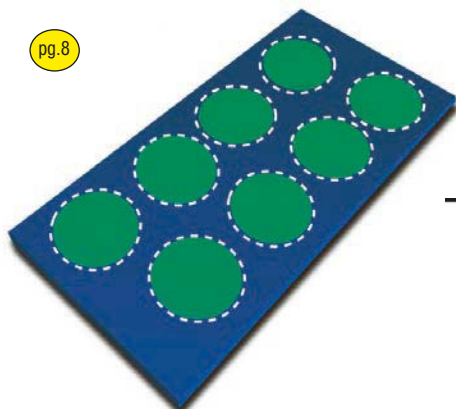

pg.8

Per riabilitazione post-traumatica, ginnastica dolce, coordinazione e propriocizione
For injury recovery, soft gym, body coordination and equilibrium training

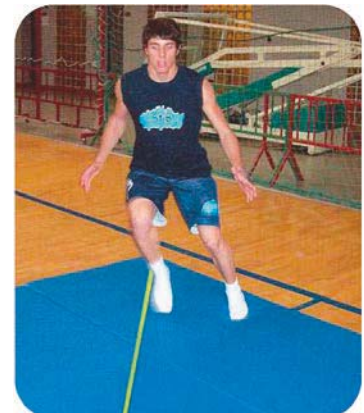
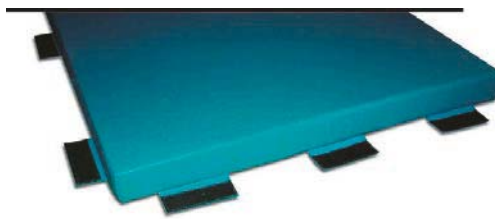



Art. V9178
Plinto per pliometria regolabile in altezza da cm. 30 a cm. 45 in tubolare di acciaio zincato piano di appoggio in legno multistrato dim. cm.150x30
 Plyometric bench adjustable heights (from 30 to 45 cm.) in galvanized steel wooden board dim. 150x30 cm.

pg.10



Art. 1PP40/2PP40/3PP40/1PP50/2PP50/3PP50
Panca per pliometria in acciaio verniciato, lunghezze disponibili: cm. 100 / cm. 200 / cm. 300 larghezza cm. 35 altezze disponibili: cm. 40 / cm. 50 piano di appoggio in legno rivestito in gomma antiscivolo
 Plyometric bench in painted steel, available length 100 / 200 / 300 cm. width 35 cm. available height 40 / 50 cm. board made of wood with anti-skid rubber cover



Art. AHF-140
Parallelepipedo per pliometria in legno cm. 76x61x51 utilizzabile a 3 diverse altezze
 Wooden plyometric box 76x61x51 cm. 3 different heights



Art. AHF-164
Parallelepipedo per pliometria in legno cm. 76x61x51 con imbottitura in EVA sp. cm. 2 utilizzabile a 3 diverse altezze
 Wooden plyometric box 76x61x51 cm. EVA padding 2 cm. thickness 3 different heights



Art. VCU60 / VCU70 / VCU80
Cubo per pliometria in legno verniciato al naturale con gomma antiscivolo sui piani di appoggio lato cm. 60/70/80
 Wooden plyometric cube with anti-skid rubber 60/70/80 cm. side



Art. PAV2 Set 3 plinti soft a basi rettangolari, sovrapponibili - 3 altezze ottenibili: cm. 30, 60, 90 in gommapiuma rivestita con PVC ignifugo Cl. 1
 Set of 3 rectangular base soft steps - by placing them one upon the other you can get 3 different heights: 30, 60, 90 cm.

TRAMPOLINI - Trampolines



Art. 166
Trampolino elastico Ø cm. 97
Trampoline Ø 97 cm.

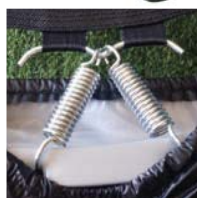

pg.7



Art. TF-03
Trampolino elastico Ø cm. 122
pieghevole - 40 molle
Trampoline Ø 122 cm.
foldable - 40 springs

Art. V1709
Trampolino elastico
ad altezza fissa
dim. cm.125x125
Trampoline 125x125 cm.
reinforced



Art. S01154
Trampolino elastico
ad inclinazione
regolabile
completo di protezioni
dim. cm. 125x125
Trampoline
size 125 x 125 cm.
adjustable inclination
with soft perimetric
protection

Art. TRO-9
Trampolino da esterno Ø cm. 305
con rete di protezione perimetrale
Outdoor trampoline cm. 305 diameter
with perimetric protection net



SCALE - CERCHI - CORDE - Speed Ladders - Hoops - Jumping Ropes

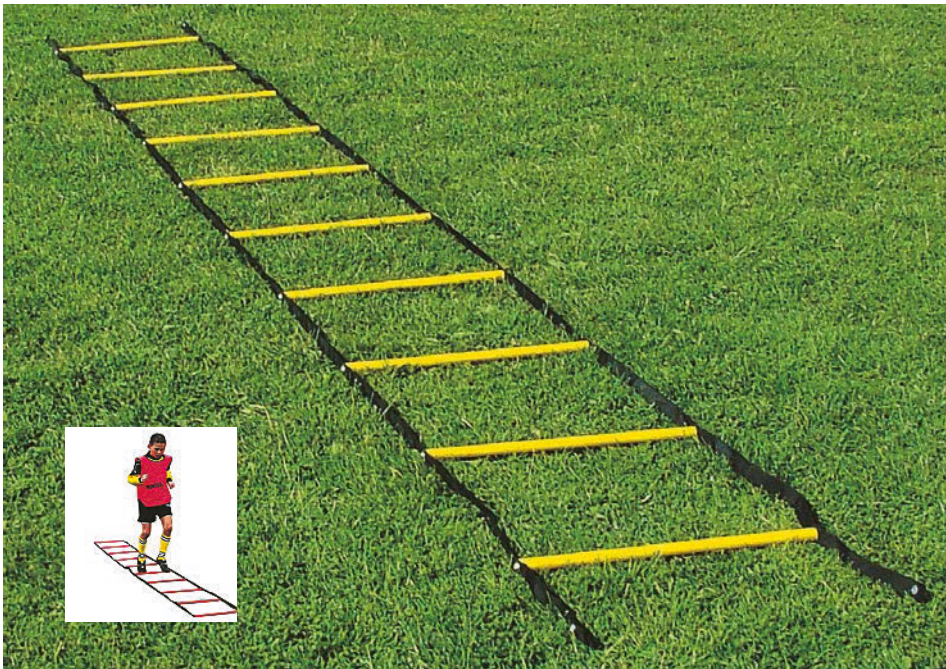

Art. SL4

Scala lunghezza m. 4 con 10 pioli rotondi per esercizi di coordinazione motoria (compresa sacca per il trasporto)

Speed ladder length 4 meters with 10 tubular rungs for quick step and coordination exercises, bag included

pg.9



Art. SL4LP

Scala lunghezza m. 4 con 8 listelli piatti a distanza regolabile per esercizi di coordinazione motoria (compresa sacca per il trasporto)

Speed ladder length 4 meters with 8 adjustable flat rungs for quick step and coordination exercises, bag included



Art. SL6

Scala lunghezza m. 6 con 12 listelli piatti a distanza regolabile (compresa sacca per il trasporto)

Speed ladder length 6 meters with 12 adjustable flat rungs, bag included

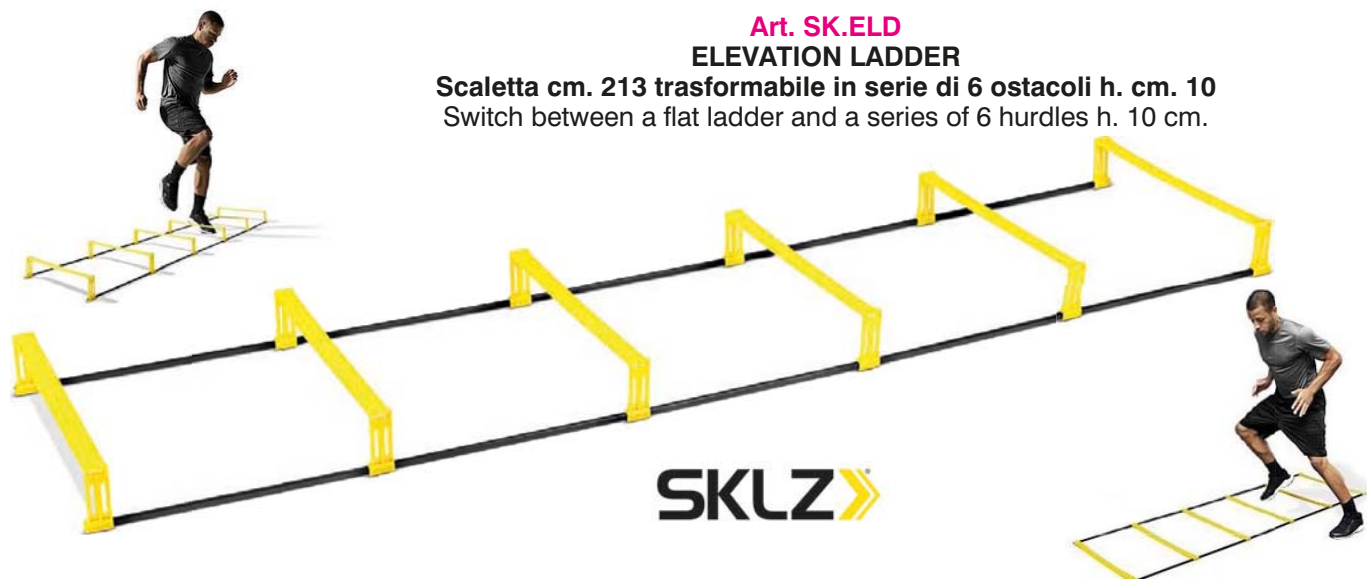

Art. SK.ELD

ELEVATION LADDER

Scaletta cm. 213 trasformabile in serie di 6 ostacoli h. cm. 10
Switch between a flat ladder and a series of 6 hurdles h. 10 cm.

pg.9



Art. B704086

Scala in plastica flessibile lunghezza m.4 con 10 pioli spessore cm.1,5
dimensione quadri cm.40x40 pieghevole con rimessaggio

Flexible speed ladder length 4 meters in plastic pipes 1,5 cm.
thick - foldable with holder

Art. 701411

Minibirillo

concavo altezza cm. 9
per sollevamento
scala Art. B704086

Cone 9 cm. height carved on
top for Art. B704086
underneath support

Art. K4111

Kit scala Art. B704086

+ 20 Minibirilli Art. 701411

Kit Art. B704086 + 20 x Art. 701411



Art. 995215

Cor Web da 36 quadri cm. 35x35
dimensioni totali cm. 465x120
composto da 13 stecche gialle semirigide
e 4 strisce in cinghia rossa
(disponibile fino ad esaurimento scorte)
Speed ladder 36 squares 35x35 cm. each
overall dimensions 465x120 cm.
(until available in stock)

Art. 995216

Borsa per Cor Web in nylon con cordino e
stopper per chiusura, con maniglia per il trasporto
Bag for Cor Web 36 squares

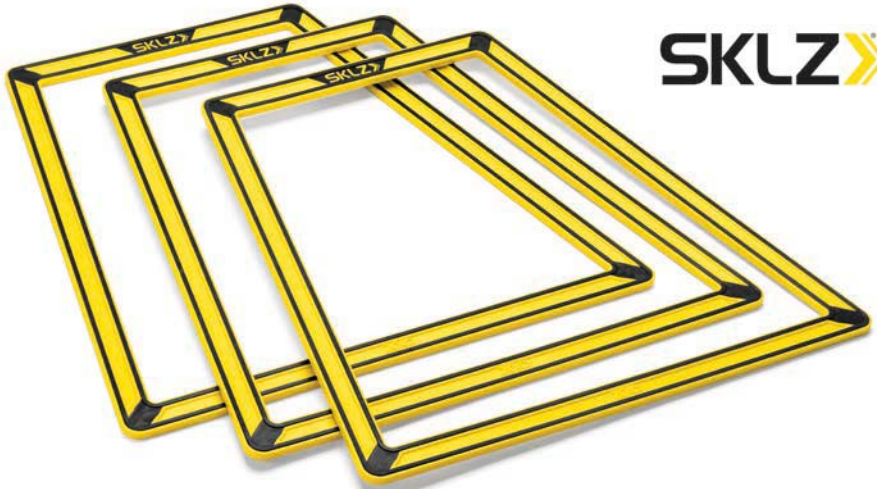

SKLZ

Esempi di combinazioni possibili
A few examples

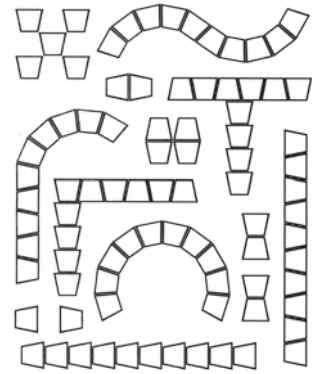

Art. SK.ATP
AGILITY TRAINER PRO - set 10 TRAPEZI componibili per allenamento agilità e coordinazione multidirezionale, e per il miglioramento della velocità e dei tempi di reazione

Agility Trainer Pro - customizable footwork and agility trainer designed for curvilinear and alternative training patterns, cuts your reaction time while adding speed in all directions. Set of 10 trapezoids with a carry handle



Con questo nuovo strumento di allenamento creativo si possono incrementare le doti di rapidità, agilità e potenza nei cambi di direzione e nelle traiettorie curvilinee che gli atleti sono chiamati ad effettuare durante la gara. Questi speciali trapezi sono molto stabili su ogni tipo di terreno, permettendo così un esercizio senza interruzioni



Sports don't happen in a straight line, now neither does your training. The Agility Trainer Pro lets you recreate the curvilinear and broken patterns that take place in sports, helping you set up your cuts, turns and changes of direction. It lets you add the multi-directional quickness and precise footwork that can quickly change the game. The Agility Trainer Pro won't slip, slide or otherwise interrupt your training sessions

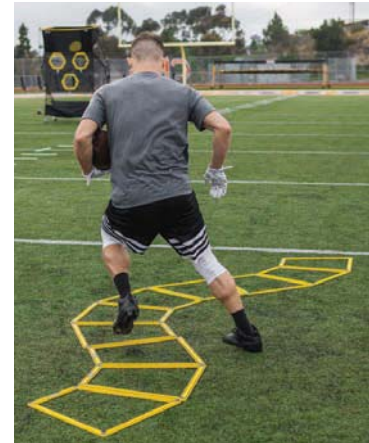

Art. HEXS6 Set 6 esagoni in plastica componibili dim. cm.45x53 (altezza, larghezza) lato cm.28, completi di clip e borsa colori: giallo, verde, rosso, arancio, azzurro

Set of 6 modular plastic hexagons 45x53 cm. (height, width) complete with clips and bag - colors: yellow, green, red, orange, royal

**Video dimostrativo disponibile
su www.barretsport.com
Video available on
www.barretsport.com**



Art. SQ15.NS
**Set 6 elastici con
velcro di ricambio**
Set of 6 spare elastics
with velcro

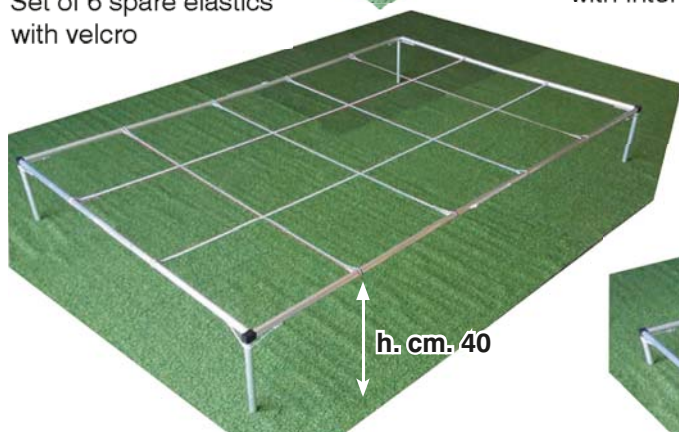

Art. SQ15
15 SQUARES
Telaio di cm. 300x200
in alluminio Ø mm.32
6 elastici con velcro consentono
di formare 15 quadri per esercizi di
coordinazione, reattività, riscaldamento
e potenziamento muscolare
con piedi di sostegno intercambiabili
utilizzabile alle seguenti altezze
dal terreno: cm.0 / cm.20 / cm.40 / cm.60
kit completo di borsa per il trasporto
e di 6 elastici di ricambio (che consentono eventualmente
di formare un numero maggiore di quadri)

Aluminium frame 300x200 cm. pipe Ø 32 mm.
equipped with 6 elastic bands with velcro forming 15 squares for
warm up, coordination, reactivity and jumping exercises
with interchangeable sets of support feet adjustable at the following
heights from ground: 0 cm. / 20 cm. / 40 cm. / 60 cm.
with carrying bag and 6 additional spare elastics
(which eventually allow you to form
a greater number of squares)

pg.9



**Morbidi elastici
flessibili fino
a terra**
Soft elastic
bands
flexible down
to the ground

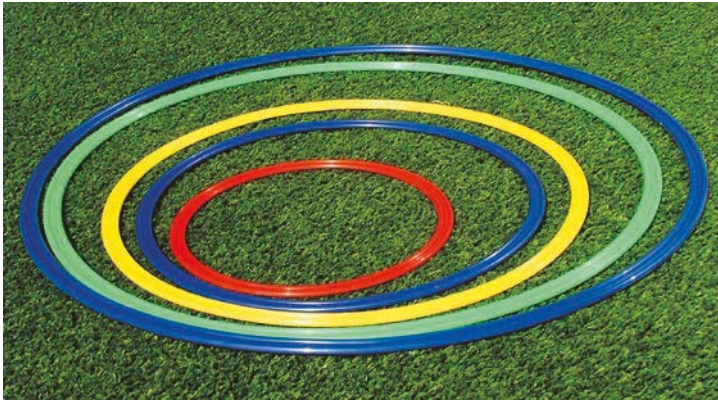

Art. CNP30 / CNP40 / CNP50 / P00181 / P00191 / P00201
Cerchio in nylon piatto Ø cm. 30 / 40 / 50 / 60 / 70 / 80
 Flat Nylon Hoop Ø 30 / 40 / 50 / 60 / 70 / 80 cm.
 4 colori - 4 colors



Art. P00182 / P00192 / P00202 / P00212
Cerchio in PVC tubolare
 Ø cm. 60 / 70 / 80 / 90 colore rosso o giallo
 Tubular PVC hoop
 Ø 60 / 70 / 80 / 90 cm. red or yellow color

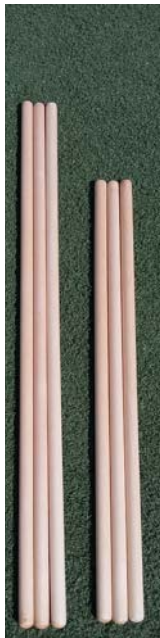

Art. S00402/S00405
Bastone in legno
 cm. 80-100
 80-100 cm. Wooden Stick



Art. E21
Bastone in PVC cm.120
 120 cm. PVC Stick

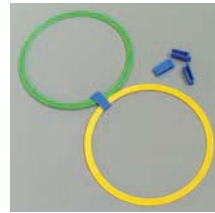

Art. OCC11
Connettore per cerchi piatti
 Flat Hoop Connector



Art. S00472
Mensola porta cerchi a parete in acciaio verniciato
 Hoop wall Holder in painted steel

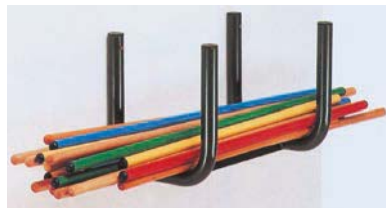

Art. S00414
Mensola porta bastoni a parete in acciaio verniciato
 Stick wall Holder in painted steel

pg.8

Art. 043P
Corda per salto in nylon con manici in legno
 Nylon Skipping Rope with hardwood handles



Art. 043
Corda per salto in canapa con manici in legno ed ingrossamento centrale
 Hemp Skipping Rope with hardwood handles, thicker in the middle section



Art. AHF-017
Corda per salto in PVC con manici soft touch e cuscinetti a sfera
 PVC Skipping Rope with soft handles and ball bearings



Art. CS1
Corda per salto in canapa con ingrossamento centrale senza manici
 Hemp Skipping Rope thicker in the middle without handles

Art. AHF-102
Corda per salto veloce in acciaio con manici in plastica e cuscinetti a sfera (lunghezza regolabile)
 Steel Skipping Rope with plastic handles and ball bearings (adjustable length)



Art. 043L Corda per salto in pelle
 Leather Skipping Rope with hardwood handles



Art. STAR
Starkick completo di cintura e corda elastica per allenamento ai palleggi ed al tocco di palla (pallone escluso)
 Starkick with belt and elastic rope for ball kick and control training (ball not included)



Art. PTI.15070
Soccer Ball Trainer completo di pallone, corda elastica di m. 12,5 e ancoraggio
 Soccer Ball Trainer with ball size 5 in TPU, rubber base, 12,5 m. elastic rope and 1 peg

pg.9



Art. OTK
Training Kicker con corda non elastica per allenamento ai palleggi ed al tocco di palla (pallone escluso)
 Training Kicker with non elastic rope for ball kick and control training (ball not included)



Art. TIM.SP
Supporto per Tackle Improver
 Holder for Tackle improver

Art. TIM
Tackle Improver per allenamento al contrasto
 For tackle training

Uno strumento innovativo per migliorare la tecnica di esecuzione e la potenza del contrasto. Il Tacke Improver indirizza il piede d'appoggio verso la posizione più idonea per esprimere la maggiore potenza d'impatto. Potenzia inoltre tutte le catene muscolari che intervengono nel contrasto, ma senza causare traumi, grazie ad una speciale molla collegata al pistone che sorregge il pallone.

Very useful training device for strengthening all muscles involved in tackling. Absolutely safe, thanks to a spring and piston system that avoids injuries.



pg.9



Art. CVCO
Cavigliera Coordinativa con contrappeso, migliora l'equilibrio e l'indipendenza psicomotoria delle gambe, ed in particolare ammorbidisce la gamba dominante migliorandone la sensibilità del piede
 Rotating ankle, with weight, to improve equilibrium and leg independence: in particular it softens the dominant leg improving sensibility of the non dominant foot



pg.9

Video dimostrativo disponibile su www.barretsport.com
 Video available on www.barretsport.com

ALLENAMENTO SOTTO CARICO E FUNZIONALE - Training with weights



Art. ASN

Cintura in pelle sintetica con velcro completa di corda, catena e moschettoni **di ricambio** per slitta Art. SLD
Synthetic leather belt, rope and chains spare for Art. SLD



Art. SLD

Art. SLD Slitta per il miglioramento della capacità di accelerazione tramite il traino a carico variabile completa di cintura in pelle sintetica con velcro, corda e moschettoni (dischi in ghisa non inclusi)
Sledge (weights not included) improving acceleration with synthetic leather belt, rope and chains



Art. CBV

Cintura in pelle sintetica con velcro **di ricambio** per Art. SLD
Synthetic leather belt w/velcro spare for Art. SLD

pg.9



SKLZ

Art. SK.SPSC

SPEED SAC - sacca di traino con pesi munita di cintura e moschettone utilizzabile anche indoor o su superfici sintetiche

Improves overall speed and explosiveness, boosts acceleration and stride length. Adjustable weight options for variable resistance portable and versatile to be used anywhere



In dotazione 3 sacchi di capacità Kg. 4,5 da riempire con sabbia
Includes 3 x 4,5 Kg. sacs to be filled with sand



pg.8



Art. 045

Giubbino caricabile con pesi fino a Kg.10 (pesi inclusi)
Jacket Weighted up to 10 Kg. (weights included)



pg.9

Art. PCH

Paracadute per potenziamento della corsa
Parachute to improve the power of your run



New!

**Art. BB5D/BB8D/
BB12D/BB17D**
Shoulder Bag
con 3 impugnature
pesi disponibili
Kg. 5-8-12-17
Shoulder Bag with
3 handles
weights available
5-8-12-17 Kg.

pg.8



Art. TBB2 / ... / TBB6
Body Bar
Kg. 2-3-4-5-6 per
allenamento funzionale
con pesi liberi
Body Bar
2-3-4-5-6 Kg.
for functional training
with free weights

pg.12



**Art. PBG-5N/PBG-10N/PBG-15N
PBG-20N/PBG-25N**
Borsa Zavorrata
con 6 impugnature
pesi disponibili Kg.5-10-15-20-25
Heavy Bag with 6 handles
weights available 5-10-15-20-25 Kg.

pg.8

pg.9

Art. BGZ
Borsa Gonfiabile zavorrata con acqua a peso variabile
(capacità massima 12 litri) cm. 85 con 4 maniglie
consente nuovi esercizi di forza coordinata
grazie alla massa oscillante interna
Inflatable Bag with water inside (maximum 12 liters), length cm. 85
with 4 handles allows new exercises for muscle strength thanks to
the dynamic weight inside



Art. V5083
Pedana di salto in tubo in acciaio dim. cm. 100x100
con elastico rigido a tensionamento uniforme
e dinamometro, cintura e moschettoni
(dischi in ghisa non inclusi)
Jump Platform in painted steel dim. 100x100 cm.
with elastic rope and dynamometer, belt and snap-hooks
(weights not included)

pg.9



Art. BR-3812 / BR-5015
Fune da allenamento
Battle Rope
ø mm 38 lunghezza mt. 12
oppure
ø mm 50 lunghezza mt. 15
Battle Rope
12 meters - 38 mm. thick or
15 meters - 50 mm. thick

pg.9



**In poliestere intrecciato con impugnature rivestite in gomma termoretraibile
ideale per il potenziamento dei muscoli di spalle e avambracci,
ottimo allenamento cardiorespiratorio**
Polyester encased rope with shrink-wrap handles, perfect for strengthening shoulders
and forearm muscles, excellent cardio-respiratory workout

FUNCTIONAL TRAINING



pg.9

FT.IST
Functional Training
Attrezzo polifunzionale
per il potenziamento della catena estensoria
e flessoria degli arti superiori e inferiori
 Functional Training multi-purpose
 belt for the enhancement
 of the extension and flexion muscular
 chains of the upper
 and lower limbs



FST-DBL

Functional Training Double Pro
Attrezzo professionale per allenamento
in sospensione con maniglie svincolate
utilizzabili separatamente
 Functional Training with free handles to be used also
 separately - steel snap hooks and rings



MTLTX
Lacci di Trazione
 Traction Laces

pg.9

PLTRZ
Prolunga
per Lacci
di Trazione
 Extension for
 Traction Laces



Attrezzo polifunzionale per il potenziamento della catena estensoria e flessoria degli arti superiori e inferiori
 Multi-purpose belt for the enhancement of the extension and flexion muscular chains of the upper and lower limbs



Art. DTL15
Lacci di Trazione
dinamici
con carrucola
 Dynamic functional
 training with pulley

BANDE ELASTICHE - BOA - Elastic Bands



Art. IFBG
Fitness band colore giallo
yellow
cm. 175x15

Art. IFBR
Fitness band colore rosso
red
cm. 175x15

Art. IFBB
Fitness band colore blu
blue
cm. 175x15

Art. IFBN
Fitness band colore nero
black
cm. 175x15



Art. 991707 / 991708 / 991709
SET 10 ELASTICI AD ANELLO
colore giallo (morbido) - rosso (medio)
verde (resistente) Ø cm. 27,50
Elastic Rings yellow (soft) - red (medium)
green (hard) 27,5 cm. Ø



Art. AHF-141
Coppia maniglie per fitness band
Pair of handles for fitness band

pg.11

Art. AHF-251/AHF-128/AHF-129
AHF-130/AHF-131/AHF-132

Elastico ad anello POWER BAND
circonferenza cm. 208 spessore mm. 4,5
larghezza giallo mm. 6,4 - rosso mm. 13 - nero mm. 22
viola mm. 29 - verde mm. 45 - blu mm. 64
Power Band elastic circumference cm.208 - 4,5 mm. thick
yellow 6,4 mm. width - red 13 mm. width
black 22 mm. width - violet 29 mm. width
green 45 mm. width - blue 64 mm. width



Art. RLEV
Rotolo lattice verde per esercizi muscolari,
larghezza cm. 15, lunghezza mt. 25
spessore 0,3 mm.
Elastic green Band for muscle exercises,
15 cm. wide, 25 meter long, thick 0,3 mm.

pg.11

Art. RLEF
Rotolo lattice fucsia per esercizi muscolari,
larghezza cm. 15, lunghezza mt. 25
spessore 0,4 mm.
Elastic fuchsia Band for muscle exercises,
15 cm. wide, 25 meter long, thick 0,4 mm.



Art. RLEB
Rotolo lattice blu per esercizi muscolari,
larghezza cm. 15, lunghezza mt. 25
spessore 0,5 mm.
Elastic blue Band for muscle exercises,
15 cm. wide, 25 meter long, thick 0,5 mm.



Art. AHF-068
Set 3 elastici tubing con maniglie
tre differenti livelli di resistenza
impugnature ergonomiche soft touch
per esercizi arti superiori e inferiori
completo di borsa in microrete
Set 3 elastics with handles
3-level resistance - soft touch handles,
bag included - tones and strengthens
arms, legs, gluteus, abdominals,
shoulders and chest muscles



Art. KER-IS

Set 5 elastici con 5 diverse resistenze dotati di ganci metallici da entrambi i lati. Completo di 1 coppia di maniglie, 1 coppia di cavigliere, 1 accessorio per bloccare l'elastico contro una porta e utilizzare un arto per volta, 1 sacca
 Set of 5 elastic bands with 5 different resistances equipped with metal hooks on both sides. Complete with 1 pair of handles, 1 pair of ankle bands, 1 accessory to lock the elastic against a door and use one limb at a time, 1 bag

Here are some examples of the door anchor in action:

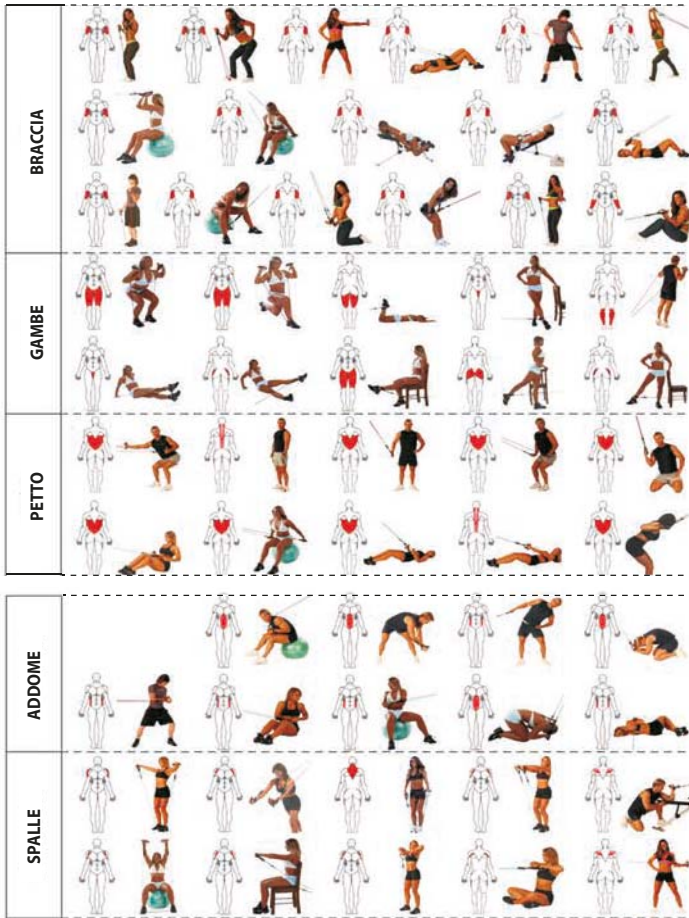

| COLORE ELASTICO | LIVELLO DI RESISTENZA | LIVELLO DI RESISTENZA | DIMENSIONI |
|-----------------|-----------------------|-----------------------|-------------|
| GIALLO | EXTRA LEGGERO | 2,7 kg - 3,6 Kg | 5X8X1100MM |
| VERDE | LEGGERO | 4 kg - 5 Kg | 6X9X1100MM |
| ROSSO | MEDIO | 5,5 kg - 6,75 Kg | 5X9X1100MM |
| BLU | FORTE | 6,75 kg - 9 Kg | 5X10X1100MM |
| NERO | EXTRA FORTE | 9,45 kg - 11,25 Kg | 6X11X1100MM |

1. Your resistance bands come in 5 different resistance levels, noted by a different band color. Please refer to the table for more information on the levels of resistance
2. You can use any or all of the bands at one time during your workouts
3. Attach one end of the band(s) to the foam handles or ankle straps and same on the other end
4. The door anchor will attach anywhere on a standard door, including the bottom of the door. To use the door anchor, ensure the bigger end is attached to the apposite side of door and feed the thin end through. Once the thin end is through you can feed the exercise band through it. Ensure the door is fully closed before performing any exercise

pg.11

| Resistance Band Color | Resistance level | Resistance level | Dimensions |
|-----------------------|------------------|------------------|-------------|
| Yellow | X - Light | 6lbs - 8lbs | 5X8X1100MM |
| Green | Light | 9lbs - 11lbs | 6X9X1100MM |
| Red | Medium | 12lbs - 15lbs | 5X9X1100MM |
| Blue | Heavy | 15lbs - 20lbs | 5X10X1100MM |
| Black | X-Heavy | 21lbs - 25lbs | 6X11X1100MM |

Art. 991710/ ... /991738

Elastico tubing con maniglie colore rosso, giallo, viola, nero
 Elastic with handles
 red, yellow, violet, black color



Art. 991714/ ... /991742
Elastico tubing mt.10 senza maniglie colore rosso, giallo, viola, nero
 10 meter elastic without handles
 red, yellow, violet, black color

Art. 016824

ELASTICO BOA in gomma para mm. 7x18 rivestito con guaina di sicurezza lunghezza mt. 3 con un moschettone a ciascuna estremità, resistenza Kg. 50

Rubber BOA 7x18 mm. with safety sheath 3 meter length, resistance 50 Kg.

pg.10 pg.11



Art. 016827

Paio polsini per elastico BOA

Pair of wristbands for BOA exercises



Art. 016824
ELASTICO BOA

Art. 016826
CINTURA Senior

Si suggerisce l'utilizzo dell'elastico BOA con una cintura o con un altro tra gli accessori disponibili

Utilization of rubber Boa is suggested with a belt or with another available accessory



Art. 016828

Paio cavigliere per elastico BOA

Pair of anklebands for BOA exercises

Art. 016825

CINTURA Junior da agganciare a elastico BOA diametro max cm.105

Junior Belt for BOA traction - max diameter 105 cm.

Art. 016826

CINTURA Senior da agganciare a elastico BOA diametro max cm.140

Senior Belt for BOA traction - max diameter 140 cm.

pg.11



Art. 016829

Pettorina per elastico BOA

Shoulder belt for BOA exercises



Art. C3005

Staffa per ancoraggio elastico BOA a parete
BOA wall anchor bracket



Anello scorrevole
"free-floating" ring



SKLZ

Art. SK.R360

RECOIL 360 - elastico con cintura ad anello scorrevole utilizzabile in autonomia o con l'aiuto del preparatore resistenza Kg. 22

Maximizes power, speed and vertical jump
Engineered with a "free-floating" ring for 360 degrees of movement
Designed for solo use or for training with a partner
resistance 22 Kg.

pg.11

DYNAMIC RESISTANCE / ASSISTANCE TRAINER



Art. SK.ACTR

ACCELERATION TRAINER

per l'allenamento della velocità in ogni direzione,
dell'accelerazione e della velocità massima

Da utilizzare con l'aiuto del preparatore

Trains speed in every direction

Builds speed and power from the start,
during acceleration and at the top-end

Designed for training with a partner



pg.10

DYNAMIC OVERLOAD AND RELEASE SYSTEM



Anello scorrevole
"free-floating" ring



Art. SK.LRP

LATERAL RESISTOR PRO

Attrezzo per migliorare la velocità del primo passo
e la rapidità laterale con elastici tubolari
intercambiabili a diversa resistenza

Develops first-step quickness and lateral speed

Patented Slide-Lock system for quick, safe
switching of resistance cables



STRENGTH AND SPEED TRAINER



pg.10

VERTICAL JUMP TRAINER



Art. SK.HPZ

HOPZ 2.0

Attrezzo per migliorare la forza e la potenza dei muscoli
impegnati nell'elevazione, con elastici tubolari
intercambiabili a diversa resistenza

Builds explosive leg power and strengthens jumping muscles

You can move resistance cables on belt to target specific
muscles and change resistance cable quickly





Art. PTI.SPS

Slide Pads - paio di slide pads utilizzati per esercizi di scivolamento di mani e piedi volti al miglioramento della flessibilità e della forza muscolare
 Set of 2 pcs. - simulates many slide board exercises - conditioning tool to improve flexibility, shaping and core strength



pg.11

Art. PTI.STR

Slide Trainer - lunghezza cm.140 con 2 scarpette con velcro per lo scivolamento
 Utile strumento per sviluppare la forza laterale, la potenza, la resistenza, l'equilibrio, l'agilità, la velocità e la flessibilità
 Slide Trainer length 140 cm. with 2 gliding shoes great for developing lateral strength, power, endurance, balance, agility, speed and flexibility



pg.10

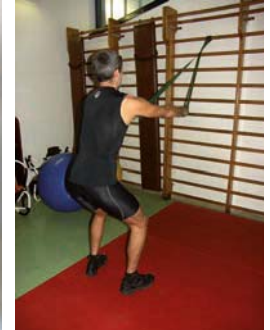

Art. AKHF

Kit Home Fitness comprendente rinforza spalle, sistema carrucolare, bastone estensibile, Antonelast uomo, Antonelast donna
 Kit includes shoulder strengthener, extensible stick, Antonelast for man and Antonelast for woman

Art. ARS.3 Banda Elastica rinforza spalle - può essere usata in ogni luogo che abbia un appiglio per la chiusura a velcro (anche in casa o in albergo) grazie alla presenza di uno spessore che, a porta chiusa, non fa scivolare l'attrezzo e non danneggia la porta
 Elastic Band for shoulder injury training exercises



Art. 05021456
JUMP-TRAINER

Strumento di allenamento per migliorare la potenza nel salto. Adatto a portieri e giocatori. Un atleta indossa la cintura regolabile con velcro, mentre due compagni di allenamento trattengono le fasce elastiche salde a terra - lunghezza delle fasce elastiche m. 1,20 ciascuna (in posizione di riposo)

Training tool to improve jump power. Suitable for goalkeepers and field players. One player puts on the adjustable hip belt with velcro fastener, two training partners hold the elastic bands on the ground using their feet. Length of elastic side bands (not stretched) 1,20 m.

pg.10



Art. 05021320

GOALKEEPER TRACTION BELT

Cintura con elastici intercambiabili per allenamento del portiere. Modificando la composizione degli elastici fissati alla base dei pali si ottengono 8 diversi tipi di resistenza (leggera, media, medio-alta, alta)

Belt with elastics for goalkeeper training.

By switching bungee ropes and connecting them to each other and to the belt in different ways, you get 8 different combinations for low, medium, medium-high, high resistance



Art. KAP

Kit allenamento portiere composto da 10 Antonelast, 1 Cintura, 1 Rinforza adduttori, 4 Anelli fissa bande per il miglioramento della forza esplosiva

Goalkeeper training kit

made of 10 Antonelast, 1 Belt, 1 Abductor muscle band, 4 connecting rings to improve explosive muscular strength and goalkeeper's jumps and dives

pg.10



Art. AE
Banda elastica
Antonelast
per esercizi di
stretching e
potenziamento
muscolare
 Elastic band for
 body muscle
 exercises



Con velcro cucito su
entrambe le estremità
with velcro seamed at
both sides



Art. RA
Rinforza abduttori
 Elastic band for
 abductor muscles

Con velcro cucito su
entrambe le estremità
with velcro seamed at
both sides



pg.10



Art. OSI

Over Speed Improver - Tramite questa cintura elastica l'atleta più veloce trascina il più lento, incrementando contemporaneamente la velocità di entrambi
 By this elastic belt the quicker player pulls the slower player, increasing both athletes' speed



Con velcro cucito su
entrambe le estremità
with velcro seamed at
both sides



Art. PSR
Power Speed
Resistor
per potenziamento
della corsa
esercizio in coppia
(nylon non elastico)
 To improve explosive
 force - two people
 involved (non elastic
 band)



Art. EPW
Elastic Power
2 fasce con cintura
in pelle
incrementa
la forza esplosiva
potenziando la
muscolatura delle
gambe e del dorso
 2 Bands with leather belt
 for explosive strength
 improvement, for leg and
 back muscle training



Art. SRE

Speed Reaction

Allenamento dei riflessi e della reattività (l'elastico non si sgancia se il difensore perde contatto dall'attaccante)

Reflex and reactivity training device (the belt does not separate if the defender loses contact)



Cintura elastica
Elastic belt



Cintura non elastica
Non elastic belt

Art. EB

Evasion Belt - Allenamento dei riflessi e della reattività ideale per marcature a uomo (la cintura si sgancia se il difensore perde contatto dall'attaccante)

Reflex and reactivity training device, for man to man coverage (the belt separates if the defender loses contact)



Art. RIM
Reaction Improver
per l'allenamento della reazione allo stimolo visivo in percorsi ad ostacoli, ideale per marcature a uomo (l'elastico si stacca se si perde contatto)
Elastic Belt for visual reflex training in drill sections, for man to man coverage (the elastic separates if following athlete loses contact)



pg.10



Art. KAT Kit allenamento tattico composto da 7 bande elastiche di metri 10 ciascuna
Tactical training Kit made of 7 Elastic bands 10 meter long each

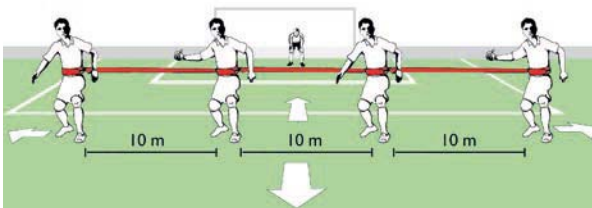
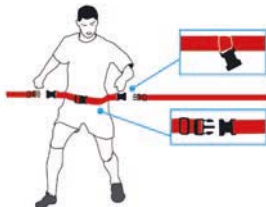

Art. 05020798

Set di 4 cinture con dispositivo di fissaggio e 3 fasce non elastiche lunghe m. 10 ciascuna

Con questo prodotto è possibile vincolare quattro difensori allenandone il posizionamento ed i movimenti sul campo

Set of 4 hip belts with fasteners and 3 unelastic bands 10 m. long each
With this kit you can connect all four players of your defensive block, training their positioning and movements on the field

Art. SC010

OFFERTA KIT TECNICO SCUOLA CALCIO

pg.9

Kit così composto: n.15 paletti slalom Art.007
n. 15 basi ad imbuto Art.018 - n. 1 kit delimitatori Art.016 - n. 6 ostacoli over cm.12 Art.80.12
n. 2 ostacoli over cm.20 Art.80.20 - n. 2 ostacoli over cm.30 Art. 80.30 - n. 2 ostacoli over cm.40 Art.80.40
n. 12 corde salto Art.043P - n. 1 scala a pioli Art. SL4 - n. 12 maxidelimitatori h.cm.28 Art.019.1
n. 12 cerchi piatti diam.cm.50 Art.CNP50 - n. 1 tavoletta propriocettiva in ABS Art.168PC

SOCCER SCHOOL KIT SPECIAL OFFER

15 x Art.007 + 15 x Art.018 + 1 x Art.016 + 6 x Art.80.12 + 2 x Art.80.20 + 2 x Art.80.30 + 2 x Art.80.40
+ 12 x Art.043P + 1 x Art.SL4 + 12(pieces) x Art.019.1 + 12 x Art.CNP50 + 1 x Art.168PC



Art. CNP50



Art. 007



Art. 016



Art. SL4



Art. 019.1



Art. 168PC



Art. 018



Art. 043P

FITNESS BODY-BUILDING

Art. S01108

Art. S01106

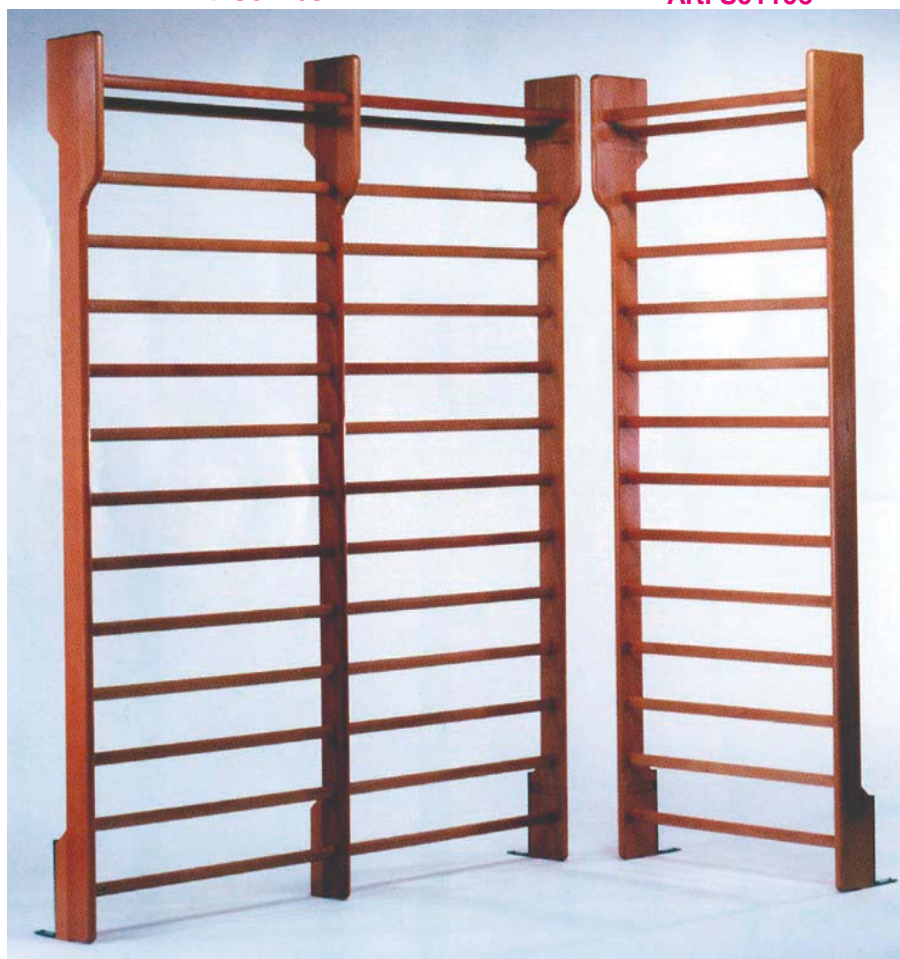

Art. S01106
Spalliera Svedese
a 1 campata
dim. cm. 90x250
in faggio evaporato
Swedish Wall Bar 1 span

pg.13

Art. S01108
Spalliera Svedese
a 2 campate
dim. cm. 180x250
in faggio evaporato
Swedish Wall Bar 2 spans



Art. S00908
Panca per addominali imbottita
agganciabile a spalliera
Abdominal bench to be fixed to
Swedish Wall Bar



Art. UNG05 / UNG1 / UNG2 / UNG3 / UNG4 / UNG5
Coppia Manubri in ghisa rivestiti
Kg. 0,5-1-2-3-4-5 cadauno
Pair of Dumb Bells from 0,5 to 5 Kg. each one

pg.12



Art. F301
Porta manubri in ferro
Dumb Bell Rack



New!

Art. MGED6 / MGED8 / MGED10
Manubrio esagonale con rivestimento in gomma Kg. 6-8-10
(fornito singolarmente)
Hexagonal Dumb Bell with rubber coating 6-8-10 Kg.



Art. AS196
Coppia fermadischi a vite
Pair of plate holders with thread

pg.11 pg.12

Art. US176
Coppia fermadischi a T
Pair of T-shaped plate holders



****Art. US304 / US305**
Bilanciere cm. 150 / cm. 180
Ø mm. 25
Weight bar length 150 / 180 cm.

****Art. US301** Manubrio a dischi inseribili
cm. 35 Ø mm. 25
Hand bar length 35 cm.



****Fermadischi inclusi**
Plate holders included
Carico massimo Kg. 100
Maximum load 100 Kg.

****Art. US303**
Bilanciere sagomato
cm. 120 Ø mm. 25
Bar length 120 cm.



Art. UN640
Dischi in ghisa foro mm.26
Kg. 0,5 - 1 - 2 - 5 - 10
15 - 20 cadauno
Cast Iron Weight Plates
hole 26 mm.



Art. DGG
Dischi in ghisa foro mm.26
rivestiti in gomma
Kg. 0,5 - 1 - 2 - 5 - 10 - 15 - 20 cadauno
Cast Iron Weight Plates hole 26 mm.
covered with rubber



Art. US287
Coppia fermadischi a molla
Pair of spring plate holders



Art. F302
Porta dischi in ferro
Weight Plates Rack



Art. 17203
Paio guanti Lycra
misure da XS a XL vari colori
Gym Gloves Lycra



Art. 30907
Paio guanti Premium Pro
misure da S a XL vari colori
Gym Gloves Premium Pro



Art. 17222
Cintura Body Building h. cm. 10 - misure da S a XL
Body Building Leather Belt h. 10 cm.
sizes from S to XL



Art. 13382 / 13383 / 13384 / 30937
Paio Cavigliere Kg. 0,5 - 1 - 1,5 - 2 cadauna
Pair of Ankle Weights 0,5 - 1 - 1,5 - 2 Kg. each one



Art. AHF-093
Paio Cavigliere Kg. 2,5 cadauna con pesi estraibili
Pair of Ankle Weights 2,5 Kg. each
removable weights



Art. AHF-026
Coppia maniglie per flessioni
Push-up handles



Art. AHF-070
Estensore con elastici
Chest-Expander



Art. AHF-161
Coppia Parallettes h. cm. 75
Pair of Parallettes 75 cm. height

pg.12



Art. AHF-074
Coppia sostegni ruotabili per flessioni
Turnable Push-up handles



Art. AHF-021
Coppia Tenaglie stringimano con impugnatura soft touch
Pincers for hand strengthening



Art. AHF-047
Ruota doppia per addominali
Double Wheel for abdominal muscles



Art. AHF-157
Coppia manubri con ruote per addominali
Pair of dumb bells with wheels for abdominal muscles



Art. AHF-063
Contapassi (ad esaurimento)
Step Counter (until available)

pg.13



Art. AHF-064
Contapassi multifunzione
Multi-function Step Counter



Art. DEAPWR

Ministepper a pistoni idraulici con elastici per il potenziamento di braccia, dorso e addome
Computer a 2 funzioni: tempo, calorie
Peso massimo utilizzatore 100 kg.

Ministepper with hydraulic rams and elastic bands for strengthening arms, back and abdomen

pg.12

Art. OCST
Gradino step a 2 altezze (cm. 10-15)
con antiscivolo dim. cm. 68x30
Step 2 heights
(10-15 cm.) with anti-skid dim. 68x30 cm.



Art. WBX-70

Power Tower

Attrezzo multifunzione ideato per l'allenamento intensivo di tutto il corpo senza l'utilizzo dei pesi
Tubolare a sezione quadrata da 5 cm.

Peso massimo utilizzatore 120 Kg.

Multi purpose tool for intensive body training without weights

pg.13



Art. AHF-003

Gradino step regolabile
a 3 altezze (cm. 15-20-25)

superficie antiscivolo dim. cm. 89x39

Step adjustable at 3 different heights
(maximum height 25 cm.)

with anti-skid surface dim. 89x39 cm.



Art. BTM

Barra per trazioni
con fissaggio a parete
Exercise Bar

pg.12



Art. BTE
Barra Entroporta
Door Bar



Art. CGF350
Panca multifunzione
telaio in acciaio,
schienale regolabile
portata massima kg. 100
Weight lifting Bench



Art. CGF450
Panca pesi con supporti
bilanciere, telaio in acciaio,
schienale regolabile
peso max utilizzatore kg. 100
Weight lifting Bench
with bar holders



Art. WBX-85
Panca piana/90° Power Bench
rinforzata (abbinabile con Power Rack)
Power Bench

ATTENZIONE: questi prodotti sono concepiti esclusivamente per uso home fitness, perciò la garanzia non copre il loro utilizzo presso palestre o centri sportivi



pg.13

Art. WBX-50
Power Rack
Supporti per bilanciere
Altezza e larghezza
regolabili
Dotato di 2 rimessaggi
per dischi
Peso massimo
caricabile 200 Kg.
Supports for weight bar



Art. GYM1000
Stazione Multifunzione
dotata di torre per dorsali, pressa per
pettorali, attrezzo per le gambe, vogatore,
cuscino per bicipiti - carico massimo 60 Kg.
(pesi inclusi), 15 esercizi praticabili
Peso massimo utilizzatore 120 Kg.
Multi purpose machine

Art. ELX-1

Ellittica con manubrio
e pedali regolabili
Sistema frenante magnetico
8 livelli di intensità con
regolazione manuale
Pulsazioni Hand Pulse
Schermo LCD
Funzioni: tempo, velocità,
distanza, pulsazioni, calorie,
recupero, odometro
Peso massimo utilizzatore 120 Kg.
Peso del volano 6 Kg.
Elliptical exercise Bike
7 function computer



ATTENZIONE: questi prodotti sono concepiti esclusivamente per uso home fitness, perciò la garanzia non copre il loro utilizzo presso palestre o centri sportivi



Art. AHF-165
Fascia da braccio
porta smartphone
Arm smartphone holder

pg.12



Art. E680
Bracciale porta oggetti
in neoprene cm.14,5x8x2
Neoprene arm wallet

Art. AB-CNH
AB Crunch Master
richiudibile
AB Crunch Master
foldable



Art. GWM13
Pedaliera manuale
utilizzabile da seduti per gli arti inferiori
e appoggiata sul tavolo per gli arti superiori
Peso 5 Kg. - con computer
Intensità sforzo regolabile
Cycling device for arm and leg exercises

pg.12



Art. GWE13
Pedaliera elettrica
per la ginnastica passiva
degli arti inferiori e superiori
Velocità regolabile
con telecomando
Peso 6 Kg. - con computer
Cycling electric device for arm and
leg exercises



Art. BFK-300

Bicicletta da camera con freno magnetico
Regolazione dell'intensità manuale a 8 livelli
Volano da 4 Kg. - Computer a 6 funzioni: tempo, velocità, distanza, calorie, scan, pulsazioni con sensori Hand Pulse
Peso massimo utilizzatore 100 Kg. - Peso dell'attrezzo 20 Kg.
Cyclette Magnetic with 6 function computer

pg.12

pg.13

ATTENZIONE: questi prodotti sono concepiti esclusivamente per uso home fitness, perciò la garanzia non copre il loro utilizzo presso palestre o centri sportivi



Art. BRX-60

Bicicletta da camera con freno magnetico
Regolazione dell'intensità manuale a 8 livelli
Volano da 7 Kg. - Computer a 6 funzioni: tempo, velocità, distanza, calorie, odometro, pulsazioni con sensori Hand Pulse
Peso massimo utilizzatore 110 Kg.
Peso dell'attrezzo 24 Kg.
Cyclette Magnetic with 6 function computer

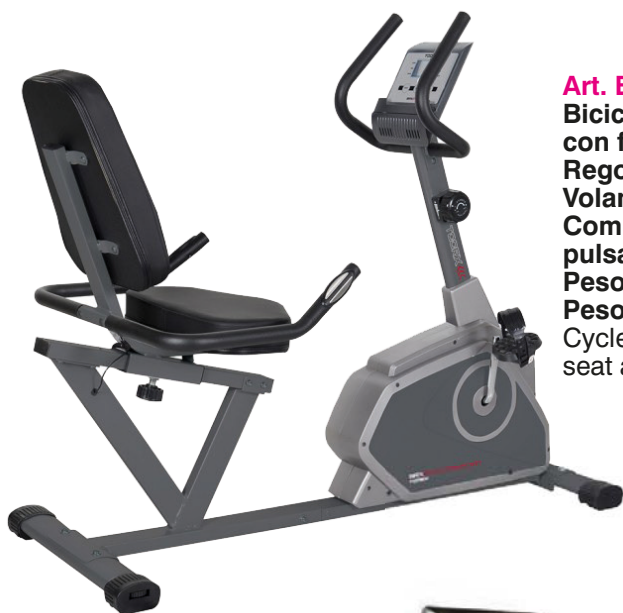

Art. BRX-RC

Bicicletta da camera BRX-R 65 COMFORT con freno magnetico e sedile con schienale
Regolazione dell'intensità manuale a 8 livelli
Volano da 7 Kg.
Computer a 7 funzioni: tempo, velocità, distanza, calorie, pulsazioni con sensori Hand Pulse, odometro, scan
Peso massimo utilizzatore 110 Kg.
Peso dell'attrezzo 29,5 Kg.
Cyclette Magnetic with 7 function computer, seat adjusting system



Art. 18220
Coprisella spinning
Seat cover
for spinning bike



Art. SRX60

Spinning Bike
SRX60 EVO
con volano da 20 Kg.
Trasmissione a cinghia con pignone fisso
Sistema di frenaggio a tampone con feltri
Computer con LCD (velocità, tempo, distanza, calorie, odometro, pulsazioni)
Sella regolabile in orizzontale ed in altezza
Manubrio regolabile in altezza con appoggio per l'avambraccio
Portaborraccia
Peso massimo utilizzatore 125 Kg.
Peso dell'attrezzo 41 Kg.
Cyclette Magnetic with seat and handle-bar adjusting systems



**Senza motore.
Adatto per camminare,
non per correre**
With no engine. Suitable for
walking, not to run

pg.13

Art. TFK-MAG

TAPIS ROULANT MAGNETICO TFK-SLIM-MAG

piano di corsa cm.38x102
sistema di frenaggio magnetico su 8 livelli
doppio volano Kg.6 - peso massimo
utilizzatore Kg.100 - display LCD indicante velocità,
frequenza cardiaca, distanza, tempo,
consumo calorico, scan, rilevazione cardio Hand Pulse
Tapis roulant magnetic with no engine,
with multi function computer



Art. TFK-200

TAPIS ROULANT TFK-200

motore 1,75/2,75 HP DC - velocità 0,8-14 Km/h
inclinazione manuale - piano di corsa cm. 42x123
peso massimo utilizzatore 100 Kg.
1 programma libero, 16 preimpostati, display LCD
indicante velocità, frequenza cardiaca, distanza,
tempo, consumo calorico, programma in esecuzione
Tapis roulant with 1,75/2,75 hp engine and
multi program computer

pg.13

ATTENZIONE: questi prodotti sono
concepiti esclusivamente per uso
home fitness, perciò la garanzia
non copre il loro utilizzo presso
palestre o centri sportivi



Art. TFK-455

TAPIS ROULANT TFK-455 SLIM - salvaspazio

motore 2,00/3,00 HP DC - velocità 0,8-16 Km/h
inclinazione elettrica - piano di corsa cm.42,5x127
peso massimo utilizzatore 110 Kg.
1 programma libero, 12 preimpostati, display LCD
indicante velocità, inclinazione, frequenza cardiaca
tramite Hand Pulse, distanza, tempo,
consumo calorico, programma in esecuzione
Tapis roulant with 2/3 hp engine and multi program computer

Art. TRXRC

**Vogatore Rower Compact - display LCD indicante
numero vogate, calorie, tempo, scan
regolazione sforzo su 12 livelli
peso max utilizzatore 110 Kg.
Rower machine with computer**



CASACCHE - Mesh Shirts



Art. 088-A

Casacca traforata fluo taglia adulto

Fluo pierced training bib adult size - colors as in the picture



Art. 088-B

Casacca traforata fluo per bambini fino a 9 anni

Fluo pierced training bib small size
(for children up to 9 years)
colors as in the picture



pg.15

Art. 088-D

Casacca traforata double-face fluo taglia adulto colori rosso/blu - giallo/arancio

Fluo pierced training bib double-face adult size
colors red/blue - yellow/orange



Art. GIL01

Gilet steward

Colori giallo - arancio
Colors yellow - orange



PANTALONCINI - CALZE - GUANTI - T-SHIRT - GIACCHE PIOGGIA Shorts - Socks - Gloves - T-shirt - Rain jackets

**** QUANTITÀ PER TAGLIA E COLORE MULTIPLA DI 5 PEZZI ****

Quantity by size and color multiple of 5 pieces



Art. MF01

Pantaloncino da allenamento
100% poliestere
taglie dalla 3XS alla XXL
Colori: royal, bianco, bordeaux,
verde, navy, rosso, nero
(quantità per taglia e colore
multipla di 5 pz.)
Shorts in polyester
size from 3XS to XXL
Colors: white, red, royal,
blue, black, brown, green
(quantity by size and color
multiple of 5 pieces)

pg.15



**Offerta sul
listino!**
Check on
price list!

Art. IS005

Paio calze calcio con piede
Taglie
Bimbo: 29-34
Ragazzo: 35-40
Uomo: 41-46
Colori: royal, giallo limone, bianco,
bordeaux, navy, rosso, nero,
Pair of soccer socks sizes: Kid, JR, SR
Colors: white, red, royal, blue, black, brown,
lemon yellow



Art. IGUAS

Paio Guanti in acrilico
colore nero
misura junior e senior
con antiscivolo
Black acrylic Gloves
size junior and senior
anti-skid



pg.16

Art. E6000

Scaldacollo in pile
taglia unica regolabile
colore navy o nero
Neck warmer in pile
one size fits all

Art. E6013
Berretto in acrilico
nero, navy
taglia senior
Winter Cap
size senior



pg.15



Art. 07761A
Giacca antipioggia con marsupio
taglie dalla XXXS alla XXL
colore navy
Rain Jacket - sizes XXXS to XXL
color blue



pg.15

pg.16

Art. TSG10/TSG11

T-SHIRT colori: bianco, nero, rosso,
verde, giallo, arancio, blu, royal
misure: bambino dalla S alla XL adulto dalla S alla XXL,
neutra oppure personalizzata con logo ad un colore
(ordine minimo per la personalizzazione 50 pezzi)
T-Shirt various colors and size, also with your logo on request
(minimum order for customization 50 pieces)

● I numeri in giallo indicano la pagina di riferimento del Listino Prezzi 2021-2022

Art. SB099

TUBOLARE BARRET in microfibra 108 dinari
Prodotto tecnico brevettato come modello d'uso CEE - Made in Italy
Lascia traspirare la pelle e ripara dal freddo e dal vento
utilissimo in molteplici situazioni:
durante e dopo gli allenamenti, durante gli incontri,
per sostenere la tua squadra, nel tempo libero, in moto etc.

Barret TUBOLAR HAT in microfiber - made in Italy patented
BTH lets your skin breath while protecting you from cold and wind
you can wear it during or after training, during the game, in your spare time,
to support your team, when riding your bike etc.

utilizzabile come scaldacollo, foulard, bandana, fascia, passamontagna etc.



it can change shape from neck warmer to head band to foulard to bandana

pg.16



Prodotto
bi-elastico
senza cuciture
bi-elastic
seamless



**A differenza del comune
prodotto in pile, la
microfibra del Tubolare
Barret impedisce il
surriscaldamento e
l'eccessiva sudorazione
della pelle, grazie
alla sua speciale
traspirazione e
leggerezza**



**PRODOTTO
TECNICO
TECHNICAL
PRODUCT**

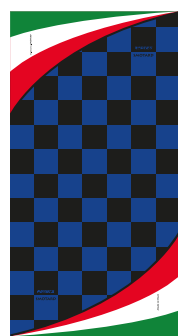
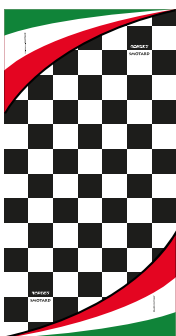

Colori disponibili:
bianco/nero, nero/azzurro,
rosso/nero, bianco/celeste,
bianco/rosso, giallo/rosso,
azzurro nazionale italiana
(prodotto personalizzabile su
richiesta per ordine minimo di
100 pezzi, con spese
per elaborazione grafica da
definire)

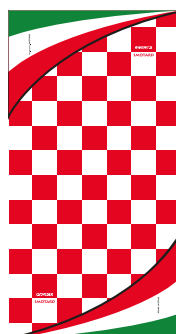
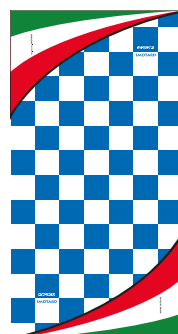
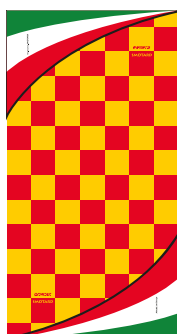

Colors available
as in the pictures
Barret tubolar HAT can be
personalized with your logo and
colors with a minimum order of
100 pieces (graphic work not in-
cluded in the price)

● Numbers in yellow show the relevant page on 2021-2022 Price List

TACCHETTI ED ACCESSORI PER SCARPE - Studs and Shoe accessories



Art. 265bis / 268bis / 270bis
Tacchetto alluminio conico
 mm. 14-17-19
 conf. 100 pz. per misura
 Conical aluminium Stud
 14-17-19 mm.
 100 piece pack



Art. BACSC
Blister 12 tacchetti in alluminio
conici con rondelle
 (8 x mm. 14 + 4 x mm. 17)
 12 piece pack conical aluminium
 studs with washers

● pg.13 ● pg.14

Art. BACS
Blister 12 tacchetti in alluminio
conici senza rondelle
 (8 x mm. 14 + 4 x mm. 17)
 12 piece pack conical aluminium
 studs without washers



Art. 262/263/264/265/266/267/268/269/270
Tacchetto alluminio conico tornito
 mm. 11-12-13-14-15-16-17-18-19
 conf. 100 pz. per misura
 Milled conical aluminium Stud
 100 piece pack



Art. PR11 / PR13 / PR14 / PR17
Tacchetto alluminio conico tornito
punta rinforzata mm. 11-13
14 (ad esaurimento) -17
 conf. 100 pz. per misura
 Conical aluminium Stud
 reinforced tip 11-13 (14 until available) -17 mm.
 100 piece pack



Art. A11 / A13 / A15 / A17
Tacchetto alluminio conico tornito
Argentinos superleggero Serie A
 mm. 11-13-15-17
 Milled conical aluminium Stud
 ultra-light Serie A
 11-13-15-17 mm.



Art. AL09F / AL11F / AL13F / AL15F
Tacchetto alluminio conico tornito Argentinos superleggero Serie A
con filettatura maggiorata (Adidas) mm. 9-11-13-15
 Milled conical aluminium Stud ultra-light Serie A
 with increased thread (Adidas) 9-11-13-15 mm.



Art. 292 / 293 / 294 / 294bis
Tacchetto in nylon conico punta rinforzata in alluminio
 mm. 11, 13, 15, 17 - conf. 100 pz. per misura
 Conical Nylon stud with reinforced tip - 100 piece pack



Art. BNPR1 / BNPR2
Blister 12 tacchetti in nylon punta rinforzata
 mm. 11-13-15 / mm. 13-15-17
 12 piece pack nylon studs with reinforced tip
 mm. 11-13-15 / mm. 13-15-17



Art. M204 / M205
Tacchetto in nylon monocolore
 mm. 13 / 16
 conf. 100 pz. per misura
 Nylon Stud
 mm. 13 / 16 - 100 piece pack

pg.14



Art. M203
Blister 12 tacchetti in nylon monocolore
 8 x mm. 13 + 4 x mm. 16
 (nero, rosso, bianco)
 12 piece pack nylon studs single color (black, red, white)



Art. 35M12
Tacchetto gomma base stretta mm. 12 conf. 100 pz.
 Narrow Base Rubber Stud mm. 12 - 100 piece pack
Art. 35M14
Tacchetto gomma base stretta mm. 14 conf. 100 pz.
 Narrow Base Rubber Stud mm. 14 - 100 piece pack



Art. 072.11.13
Confezione blister 12 Tacchetti gomma base larga per terreni gelati
 (8 x mm. 11+ 4 x mm. 13)
 Wide Base Rubber Stud - for icy ground
 12 piece pack



Art. 302 Base filettata in alluminio - conf. 50 pz. per misura
 Threaded aluminium bases mm. 7, 8, 10, 12 - 50 piece pack
Art. 302G Base filettata in alluminio - conf. 50 pz. per misura
 Threaded aluminium bases mm. 13, 14, 17 - 50 piece pack
Art. 314 Rondella in alluminio - conf. 100 pz.
 Aluminium washer - 100 piece pack



Art. CHAZ
Chiave in acciaio zincocromata
 Stud Key



Art. 317 / 318
Paio tendiscarpe a molla,
misura 40-42 / 43-45
 Shoe stretchers with spring,
 size 40-42 / 43-45

● pg.14

Art. BLS4
Lastrina antitrauma ritagliabile in gel forata
spessore mm.4 dimensioni cm.14x28
da utilizzare a contatto con la pelle del piede
dentro la scarpa in caso di ferite, vesciche o
contusioni: attutisce il dolore derivante dalla
corsa e dall'impatto con la palla

● pg.15

Anti-shock pierced gel thickness 4 mm. size
 cm.14x28 you can cut it and place it inside your
 shoe against the skin to prevent pain from running
 and kicking in case of small foot injuries

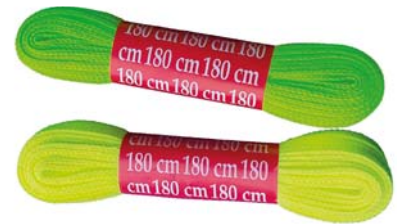
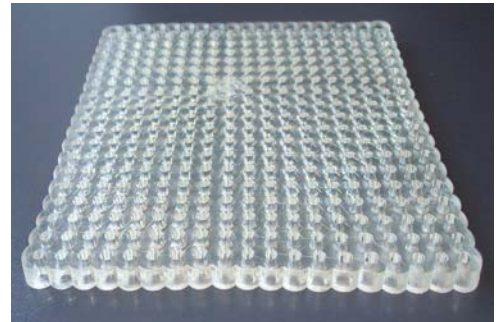

Art. 326 / 326FL / 327 / 327FL / 328 / 328FL
Paio lacci per scarpe cm.120-150-180
colori nero, bianco, giallo fluo, verde fluo, arancio fluo
 Pair of shoe laces 120-150-180 cm. long
 colors: black, white, fluo yellow, fluo green, fluo orange



Art. SOLSP
Paio solette in gel
profumate ritagliabili
 Gel Insoles



Art. ALZ.SP
Paio Alzatacco in gel
taglia 1 donna
taglia 2 uomo
 Gel under heel softeners
 woman and man sizes



Art. 21654
Paio solette
Spugna Sport
 Sport Insoles

● pg.15



Art. E6694
Paio Alzatacco in silicone
misura S (33/36) - M (37/40)
L (40/44) - XL (44/48)
 Silicone under heel softeners
 various sizes



Art. 238.1
Grasso Aquila Kg.1
Aquila Grease for shoes
Kg. 1

pg.14

Art. 238
Grasso Aquila ml. 100
Aquila Grease for shoes
ml. 100

Art. 34071A
Spray
impermeabilizzante
Spray waterproofing



pg.14

Art. D122X
Spray Dilato ml. 200
ammorbidente
Spray to soften leather
soccer shoes



Art. S489
Spazzola in setola naturale
Shoe Brush

pg.14



Art. SL.S
Spugna lucidascarpe
(ad esaurimento)
Shoe polisher sponge
(until available)



Art. TE.540.01
Zerbino pulisciscarpe
in plastica con ventose
dimensioni cm.35x27
Shoe cleaning device
in plastic with suckers
dimension 35x27 cm.

pg.15

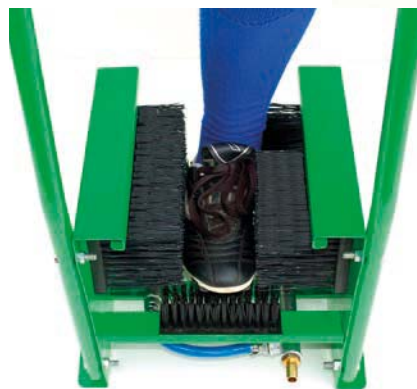

Art. FA270
Macchina lavascarpe con 4 spazzole sostituibili
getti incrociati regolabili ad alta pressione
completo di poggiamani e 4 fori di fissaggio a terra
in dotazione fascetta in acciaio per collegamento tubo
mm 15x21 (non incluso) alla rete idrica.
Shoe washing device - high pressure crossed water jets
iron frame with handles - replaceable brushes
easy fixing to the floor with 4 holes



PARASTINCHI - Shinguards



Art. PSCV
Paio parastinchi
senza cavigliera
misura adulto e bambino
Pair of shinguards
without ankle protection
junior and senior size

pg.15



Art. IS30HS
Paio parastinchi
senza cavigliera
misura S-M-L
Pair of shinguards
without ankle
protection
size S-M-L

**INNOVATIVO PARASTINCO BARRET REALIZZATO CON SPECIALI LISTELLI ANATOMICI
LEGERISSIMO MA CON ALTA RESISTENZA ALL'IMPATTO**
BARRET SPECIAL SHINGUARDS anatomic, very light and highly resistant to impact



Art. BP90

Paio parastinchi Barret senza cavigliera misura unica
Pair of Barret shinguards without ankle protection
one size fits all



**BREVETTATO
PATENTED**



Art. PBC
Paio parastinchi
con cavigliera
misura adulto
Pair of shinguards
with ankle protection
senior size



FASCE CAPITANO - GUANTI PORTIERE - Captain's Armbands - GK Gloves

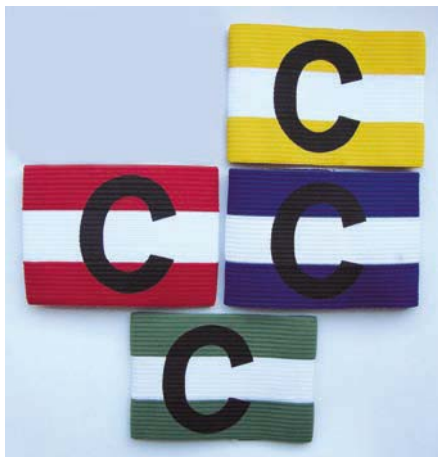

Art. 150
Fascia capitano elastica
misura adulto
Elastic Captain's armband
size adult

Art. 150.B
Fascia capitano elastica
misura bambino
Elastic Captain's armband
size children

pg.16



Art. 150F Fascia capitano elastica
mis. adulto colore giallo o arancio fluo
Elastic Captain's armband adult size
colors: fluorescent yellow and orange



Art. 150V.9
Fascia capitano con velcro, taglia adulto
colori: bianco, rosso, giallo fluo, verde,
blu e arancio fluo - h. cm. 9
Captain's armband adjustable length - 9 cm. height
size adult - colors: white, red, fluo yellow,
blue, green, fluo orange



Art. 150V / 150V.B
Fascia capitano con velcro, taglia adulto o bambino
Modello Champions colori bianco, rosso, giallo, verde,
blu, fucsia, arancio - h. cm. 6,5
Captain's armband adjustable length - 6,5 cm. height
size adult or children
colors: white, red, yellow, blue, green,
fuchsia, orange



Art. 150V.9N
Fascia capitano neutra con velcro, taglia adulto
h. cm. 9 - colori: giallo fluo, arancio,
bianco, rosso, verde, blu
Captain's armband with no "C" printed
adjustable length 9 cm. height size adult
colors: fluo yellow, orange, white, red, green,
blue



Art. 1000PG
Paio Guanti portiere misure da 6 a 11
Pair of Goalkeeper Gloves
Size from 6 to 11



pg.15

Art. F30BG
Paio Guanti
portiere junior
misure da 4 a 7
Pair of
Goalkeeper Gloves
Size from 4 to 7



I colori dei guanti raffigurati nelle immagini possono variare

NUMERAZIONI TERMOSALDABILI Numbers for Uniforms

Colori disponibili: bianco, giallo, rosso, verde, royal, blu, granata, nero, oro, argento
Available colors: white, yellow, red, green, royal, blue, brown, black, gold, silver

Art. PN23



Art. PN18



Art. PN10



● pg.16

Art. PG23

Numeri termosaldabili Serie Omega h.23 cm. in confezione da 1 a 22
Numbers for sport uniforms Omega series 23 cm. height package from number 1 to number 22

Art. PG18

Numeri termosaldabili Serie Omega h.18 cm. in confezione da 1 a 22
Numbers for sport uniforms Omega series 18 cm. height package from number 1 to number 22

Art. PG10

Numeri termosaldabili Serie Omega h.10 cm. in confezione da 1 a 22
Numbers for sport uniforms Omega series 10 cm. height package from number 1 to number 22

Art. PN23

Numeri termosaldabili Serie Omega h.23 cm. numeri singoli (da 0 a 9)
Single numbers for sport uniforms Omega series 23 cm. height (from 0 to 9)

Art. PN18

Numeri termosaldabili Serie Omega h.18 cm. numeri singoli (da 0 a 9)
Single numbers for sport uniforms Omega series 18 cm. height (from 0 to 9)

Art. PN10

Numeri termosaldabili Serie Omega h.10 cm. numeri singoli (da 0 a 9)
Single numbers for sport uniforms Omega series 10 cm. height (from 0 to 9)



TEMPERATURA MASSIMA 135 °C
TEMPO MASSIMO DI APPLICAZIONE
6 SECONDI
MAXIMUM TEMPERATURE 135 °C
MAXIMUM 6 SECOND PRINT

Art. PG4

Numeri termosaldabili Serie Omega h.4 cm. in confezione blister numeri da 1 a 100 colore bianco, blu o nero
La numerazione progressiva (di 100 in 100) arriva fino a 500
Numbers for sport uniforms Omega series 4 cm. height package from number 1 to number 100 black, blue or white color

MATERASSINI - Mats

Art. 044
Materassino pieghevole
alta densità
cm. 180x50x0,7
Folding foam Mat
high density
180x50x0,7 cm.

Art. 044-A
Materassino pieghevole
alta densità
cm. 180x60x0,7
Folding foam Mat
high density
180x60x0,7 cm.



pg.16

Art. 044-R
Materassino arrotolabile
alta densità
cm. 180x50x0,6
Rolled foam Mat
high density 180x50x0,6 cm.

Art. AS803
Materassino Exercise Mat
imbottito e serigrafato cm.180x60x2,5
PVC Mat 180x60x2,5 cm.



Art. 30924
Materassino Yoga arrotolabile
cm. 172x60x0,4
Rolled Yoga Mat 172x60x0,4 cm.

LAVAGNE TATTICHE PER CALCIO E CALCETTO - Tactical Boards for Football and Futsal

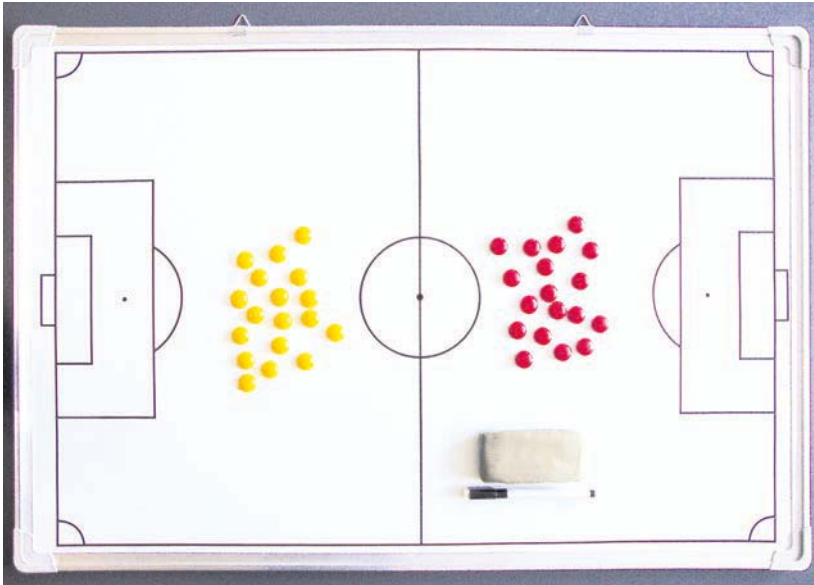

Art. 087
Lavagna magnetica cm. 60x90 cancellabile con cornice metallica
 Tactical board 60x90 cm. magnetic and erasable with metal frame

Art. 087.BO
Borsa per lavagna magnetica Art. 087 cm. 60x90
 Bag for tactical board Art. 087 60x90 cm.



Art. PM60
Serie pedine magnetiche di ricambio per lavagna Art. 087
 Spare magnetic pieces for tactical board Art. 087

pg.17

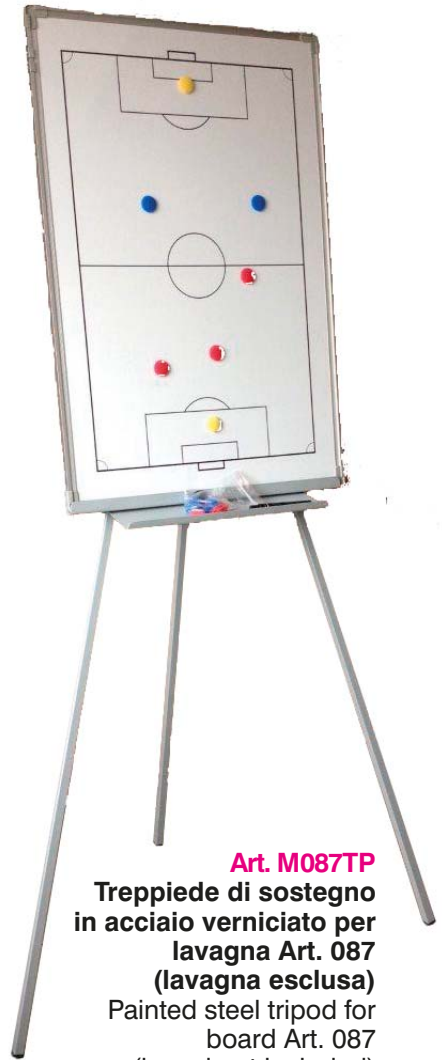

Art. M087TP
Treppiede di sostegno in acciaio verniciato per lavagna Art. 087 (lavagna esclusa)
 Painted steel tripod for board Art. 087 (board not included)



Art. 090
Lavagna su treppiede con 100 fogli cm.70x100 (non cancellabili)
 Board on tripod with 100 sheets 70x100 cm. (not erasable)

Art. 090RIC
Ricambio 100 fogli cm.70x100 per lavagna Art. 090 (treppiede escluso)
 100 spare sheets for board Art. 090 (tripod not included)

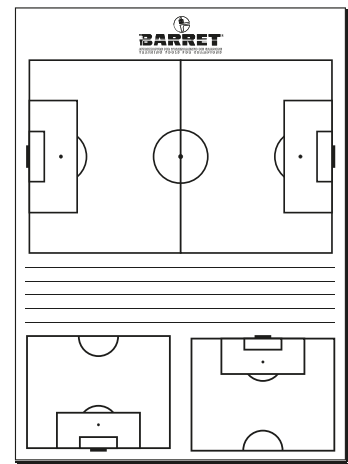

Art. BL50F
Blocco con 50 fogli formato A4 (non cancellabili)
 Block with 50 A4 sheets (not erasable)



Art. 05030425

Set 25 fogli adesivi cm.60x80 applicabili a porte e pareti, rimuovibili e cancellabili (ideale per partite in trasferta)
 Set of 25 adhesive sheets 60x80 cm. on a roll, easily separable. Due to the electrostatic charge, it can be hung on any door or wall and removed several times without leaving any trace. Ideal for away games. Either permanent or non permanent markers work for writing

● pg.17



Lato A
Side A



Lato B
Side B

Art. 089

Lavagna magnetica bifacciale cancellabile con borsa cm. 45x30
 2 face Tactical Board magnetic and erasable 45x30 cm. with bag



Art. 089-P

Lavagna magnetica cancellabile pieghevole cm. 46x25
 Foldable Tactical Board magnetic and erasable 46x25 cm.



Lato A
Side A



Lato B
Side B

Art. 089CM

Lavagna Tattica Calcio bifacciale magnetica e cancellabile cm. 45x30
 2 face Futsal Tactical Board magnetic and erasable 45x30 cm.

● pg.18

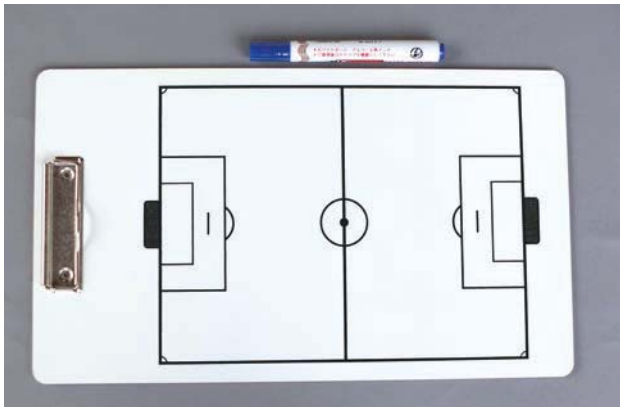

Art. 089-A
Lavagna bifacciale cancellabile cm. 40x23
 2 face Tactical Board erasable, 40x23 cm.



Art. CSRK
Lavagna Tattica magnetica cancellabile
con block-notes cm. 40x23
 Magnetic Tactical Board 40x23 cm. erasable

● pg.17

● pg.18

Art. 089-C
Lavagna Tattica
Calcetto bifacciale
cancellabile
cm. 40x23
 2 face Futsal
 Tactical Board 40x23
 cm. erasable

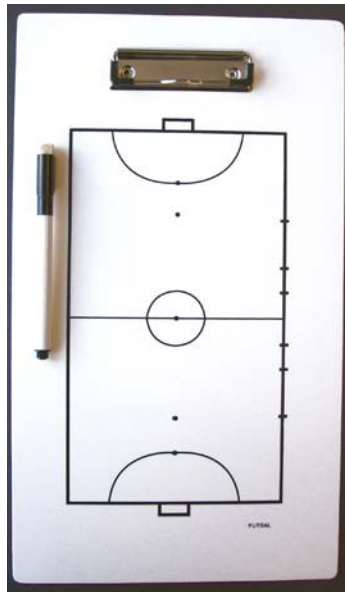

Art. PM
Serie pedine magnetiche
di ricambio per lavagne
di dimensioni ridotte
 Spare magnetic pieces
 for small tactical boards

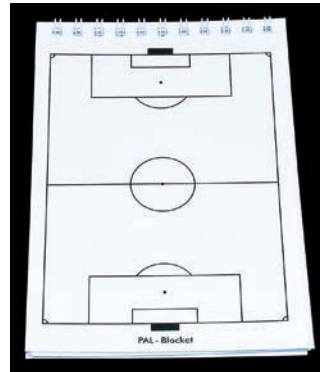

Art. PAL-B
Pal Block - blocco
tascabile con 25 pagine
copertina cancellabile
 Pocket block-notes
 25 pages with erasable cover

● pg.18



Art. 18330
Lavagna magnetica cancellabile pieghevole
Multisport (Calcio, Basket, Volley, Rugby,
Badminton, Tennis, Floorball, Pallamano,
Hockey su ghiaccio)
dimensioni cm. 32x22
 Multisport Foldable Tactical Board magnetic and
 erasable 32x22 cm.

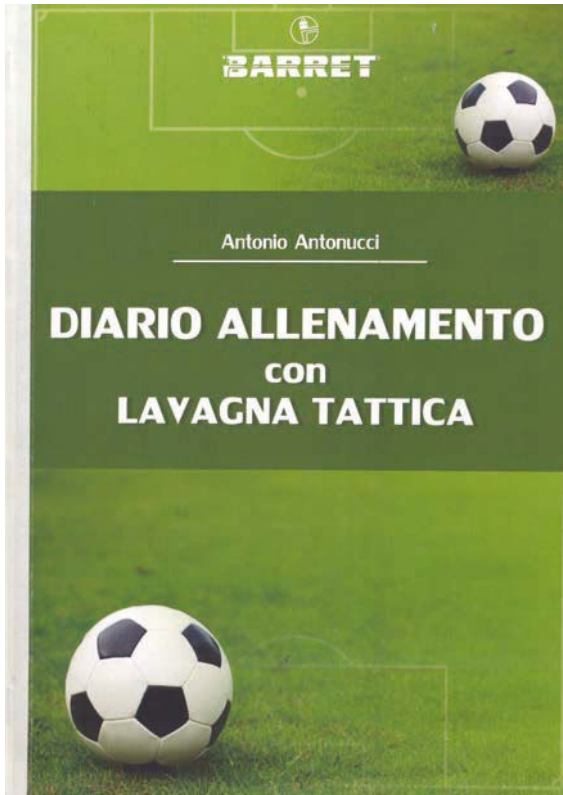

Art. DALT
DIARIO ALLENAMENTO

per l'allenatore di calcio con lavagna tattica

Lo strumento ideale per programmare e registrare durante il corso della stagione tutto ciò che riguarda la preparazione fisica generale, specifica e speciale, i test di valutazione, la preparazione psico-tattica teorica e pratica, la preparazione psico-cinetica, gli esercizi tecnico-tattici, il riscaldamento, il defaticamento e la preparazione post-infortunio della Vostra squadra di calcio e dei singoli giocatori che la compongono. E' inoltre fondamentale per l'annotazione di tutto ciò che riguarda le partite amichevoli e le partite di campionato, in relazione agli avversari da incontrare.

Il diario è corredato di una retrocopertina pieghevole utilizzabile come lavagna tattica cancellabile a 3 facce

140 pagine



● pg.18

Con lavagna cancellabile sulla retrocopertina



GHIACCIO - TAPE - CREME - OLI
Ice - Tape - Creams - Oils

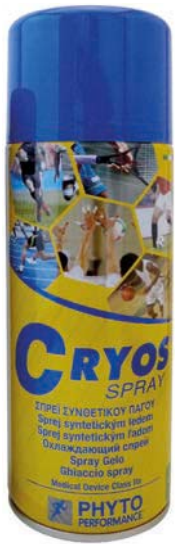

Art. 164
Ghiaccio spray
ml. 400
Ice spray 400 ml.



Art. 165
Ghiaccio
in busta monouso
Ice in envelope



Art. NE2.5
Nastro economico cm. 2,5x13,7 mt
Tape cm. 2.5x13,7 mt.

Art. NE5
Nastro economico cm. 5x13,7 mt
Tape cm. 5x13,7 mt.

Art. N2.5
Nastro tipo Strappal cm. 2,5x10 mt
Tape Strappal cm. 2,5x10 mt.

Art. N5
Nastro tipo Strappal cm. 5x10 mt
Tape Strappal cm. 5x10 mt.



Art. 9254
Salvapelle
Skin Protection

pg.17



Art. IDNC38
Nastro adesivo colorato fermacalze
cm. 3,8x13,7 mt.
colori: rosso, nero, blu, verde e giallo
Coloured Tape stop stockings
in red, black, blue, green and yellow



Art. TPG09
Fraplast cm. 8 (Tensoplast)



Art. IPT01
Cutter taglia bendaggi
Cutter for bandages

Art. IPT02
Forbice
taglia taping
in acciaio inox
Scissors for taping



Art. T255
Kinesio Tape



Art. ONC

**Olio riscaldante 500 ml
stimola la circolazione,
tonifica la muscolatura,
previene le lesioni muscolari
microtraumatiche**
Oil 500 ml
for muscle warm up, stimulating
blood circulation
and preventing micro injuries



Art. CNC

**Crema riscaldante 250 ml
stimola la circolazione,
tonifica la muscolatura,
previene le lesioni muscolari
microtraumatiche**
Cream 250 ml
for muscle warm up, stimulating
blood circulation and preventing
micro injuries



Art. IRVF

**Vaselina filante
per curare le zone della pelle a
maggiore sollecitazione**
Vaseline avoiding skin problems

pg.17



Art. IRFA

**Fango argilla per impacchi
dopo distorsioni,
per assorbimento ematomi**
Special mud to be used after
injuries (i.e. sprained ankles)
and to absorb bruises



Art. IJGE

**Crema Gel Jesic
coadiuvante per
infiammazioni, contusioni
e lesioni dell'apparato
muscolare**
Cream Gel Jesic
for treating minor injuries
and sore muscles



T10R

**Gel
freddo
refrigerante
immediato su
contusioni o
strappi muscolari**
Cold Gel for
immediate
application on
bruises and sore
muscles

T17G

**Cuscinetto
in gel
dim. cm.17x27
(effetto freddo
ed effetto caldo)**
Gel Pillow
17x27 cm.
(both for cold
and hot therapy)

T17G

BORRACCE - Water Bottles

pg.16

pg.17



Art. K8
Borraccia da 1 litro
in plastica
1 liter plastic Water Bottle

Certificate
per uso
alimentare
Food grade
certified



Art. B500ML
Borraccia
da ½ litro
in plastica
½ liter plastic
Water Bottle



Art. BAL1
Borraccia da 1 litro
in alluminio
1 liter aluminium Water Bottle



Art. BAL05
Borraccia da ½ litro
in alluminio
½ liter aluminium Water Bottle



Art. BTA05
Borraccia termica
da ½ litro in acciaio
mantiene costante la temperatura
del liquido (sia caldo che freddo)
½ liter thermic steel Water Bottle
keeps the liquid temperature
unchanged

Certificate
per uso
alimentare
Food grade
certified



Art. IRTT
Distributore termico 6 litri
con rubinetto
Thermos 6 liter with tap



pg.16

pg.17

Art. 308.C
Cestello per 6 Borracce
in plastica
Holder for 6 plastic
water bottles



Art. 306
Kit 6 Borracce
da 1 litro in plastica con cestello
Kit 6 one liter plastic water bottles
with holder



Art. C6B
Cestello per 6 Borracce
in plastica pieghevole
Foldable Holder for 6
plastic water bottles



Art. KIT6
Kit 6 Borracce da 1 litro
in plastica con cestello pieghevole
Kit 6 one liter plastic water bottles
with foldable holder



Art. OC8
Cestello per 8 Borracce
in plastica pieghevole
Foldable Holder for 8
plastic water bottles



Art. K8S6
Kit 8 Borracce
da 1 litro in plastica
con cestello pieghevole
Kit 8 one liter plastic water bottles
with foldable holder

BANDIERINE - Flags



Art. 074
Kit completo
4 paletti
calcio d'angolo
con snodo
in PVC Ø mm.32
(bandierine colore
giallo o rosso)
Kit 4 complete
flexible Corner Poles
in PVC Ø 32 mm.
(yellow or red flags)



Art. 074RP
Kit completo
4 paletti
calcio d'angolo
con snodo
rinforzati con tubo
in polipropilene
Ø mm.40
(bandierine colore
giallo o rosso)
Kit 4 complete
flexible Corner
Poles reinforced
with polypropylene
pipe Ø 40 mm.
(yellow or red flags)

pg.18



Non utilizzabili
per partite ufficiali
 Not for official
 matches

Art. 073
Kit completo
4 paletti calcio d'angolo
in PVC Ø mm.32
(bandierine colore giallo o rosso)
Kit 4 complete Corner Poles
in PVC Ø 32 mm.
(yellow or red flags)



Art. 368

Art. 368 Set ricambi
4 Bandierine calcio d'angolo
colore giallo o rosso
 Set of 4 spare Corner Flags
 yellow or red color



Art. 075 / 076
Coppia Bandierine segnalinee gialle o a scacchi con aste in plastica
Pair of linesman's Flags yellow or checked with plastic sticks

pg.18



Art. 172
Coppia Bandierine segnalinee elettroniche complete di ricevitore e borsa
Pair of electronic linesman's Flags complete with signal receiver and bag

pg.18

ACCESSORI ARBITRO - Referee's accessories



Art. 078
Fischio Fox 40 Classic senza pallina
nero o colorato
Whistle FOX 40 Classic

078PD
Fischio arbitro senza pallina
Fox 40 Classic CMG nero o
colorato con imboccatura
anatomica e cordino
Whistle FOX 40 Classic CMG
cushioned mouth grip
(cord is included)

pg.18



Art. 078SK
Fischio Fox 40 SONIK BLAST
CMG con cordino - vari colori,
con due camere sonore
Whistle FOX 40 SONIK BLAST
CMG with cord, various colors



Art. 078CH

Fischio senza pallina nero o colorato con cordino in confezione blister
Plastic whistle without a ball various colors with cord

pg.18



Art. 228C
Fischio in plastica
nero con cordino
Plastic black whistle with
cord

Art. 228
Fischio in plastica
nero
senza cordino
Plastic black whistle
without cord



Art. 079C
Fischio cromato
con cordino
Chromed brass
whistle with cord



Art. FEFOX
Fischio elettronico
Fox 40 con cordino
potenza 125 dB
Electronic Fox 40 whistle
with cord

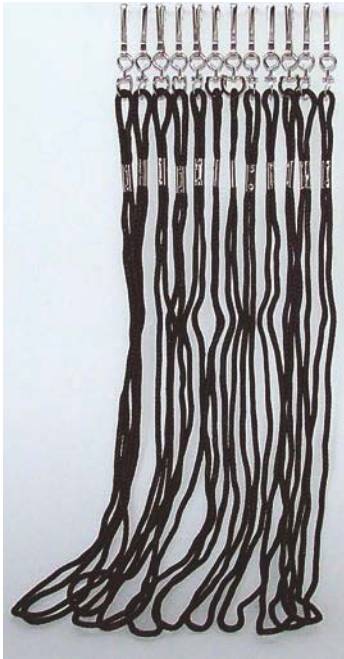

Art. 080
Cordino Lanyard
colore nero
Nylon
whistle cord Lanyard
black color

pg.18



Art. F40CAP
Cordino Fox antipanico
regolabile, vari colori
Fox whistle cord adjustable
various colors



Art. 9816
Polsino regolabile
per fischietto Arbitro
Adjustable wristband
for referee's whistle



Art. KCPFOX
Kit cronometro da polso e
fischietto Fox 40 Sonik Blast
con cordino
Kit wrist Chronometer with Fox 40
Sonik blast whistle with cord



Art. RPC
Raccoglitore ad anelli cm.18x15
per cartellini giocatori
con 20 buste trasparenti
Ring binder 18x15 cm. for players'
cards with 20 transparent envelopes



Art. 081F Coppia cartellini
giallo e rosso con custodia,
matita e tabellino gara
Yellow and red cards with holder,
pen and game note card

Art. RPCRIC
Ricambio 10 buste trasparenti per
raccoglitore ad anelli Art. RPC
Set of 10 spare envelopes for Art. RPC



Art. ZAFN
Tabellino gara di ricambio
per Art. 081F
Spare game note card for Art. 081F



Art. GR15
Coppia cartellini
giallo e rosso
riscrivibili con pennarello
(cancellabili con alcol)
Rewritable yellow
and red cards with pen
(erasable with alcohol)

pg.18

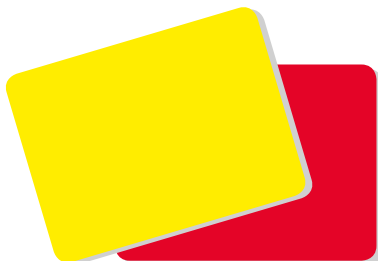

Art. RYC02
Set 1 cartellino arbitro giallo
e 1 cartellino arbitro rosso
Set 1 yellow and 1 red card for referee



Art. RCB
Cartellino arbitro blu
Blue referee card



Art. 880147
Moneta per arbitro
in plastica
rosso/nera
Referee's coin

SEGNALATORI MANUALI ED ELETTRONICI PER SOSTITUZIONI Manual and electronic Substitution Boards

Art. 071
Serie numeri
cambio giocatori
(da 1 a 25)
senza manico
Numbers for substitution
(from 1 to 25)
without handle



Art. 072
Serie numeri cambio
giocatori (da 1 a 25)
con manico
Numbers for substitution
(from 1 to 25)
with handle



pg.19

Art. E6230
Segnalatore bifacciale
economico per cambio
giocatori manuale cm.43x38
Substitution indicator
1 piece 2 sides

Lato A
Side A



Lato B
Side B



Lato B
Side B

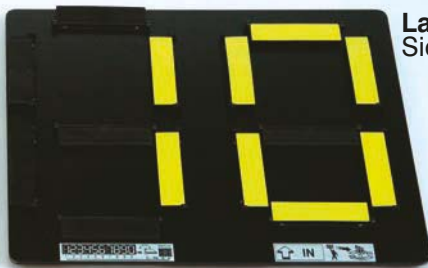
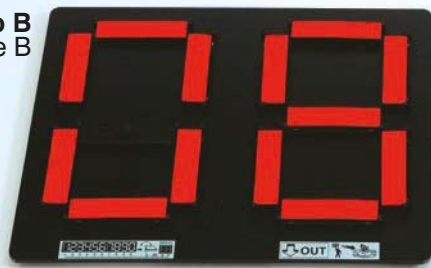

Lato A
Side A

Art. C00937
Segnalatore bifacciale per
cambio giocatori manuale
fluorescente - cm.40x32
base in plastica lucida
Substitution indicator
fluorescent 1 piece 2 sides

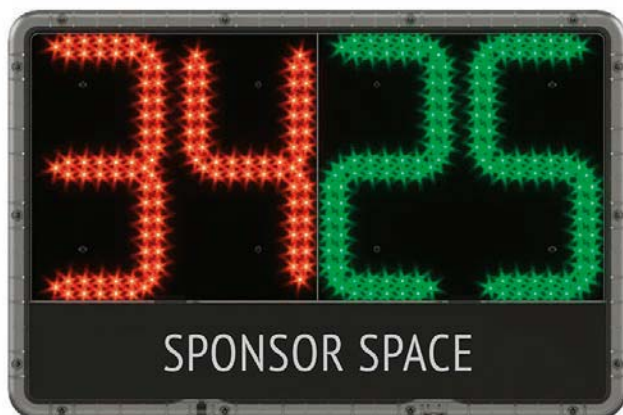

Art. F292-30
Valigetta cm. 61x40x8
per Art. FINOUT4 e FINOUT8
Case 61x40x8 cm. for Art. FINOUT4 and FINOUT8

Art. FINOUT4
Tavoletta elettronica bicolore, monofacciale
a 4 cifre (2+2) - led verdi per giocatore entrante
led rossi per giocatore uscente, completa di
caricabatteria - dim. cm. 58x38x2,7 kg. 2,2
4 Digit Electronic Substitution Board
1 side 2 color leds (red and green) cm.58x38x2,7
Kg. 2,2 with battery charger

Art. FINOUT8
Tavoletta elettronica bicolore, bifacciale
a 4 cifre (2+2) - led verdi per giocatore entrante
led rossi per giocatore uscente, completa di
caricabatteria - dim. cm. 58x38x2,7 kg. 2,25
4 Digit Electronic Substitution Board
2 sides 2 color leds (red and green) 58x38x2,7
Kg. 2,25 with battery charger

Art. 065-EC

**Tavoletta elettronica bifacciale, bicolore
DELTA 2FE1 cm.46x33x1,8 Kg.1,5
completa di valigetta e caricabatteria**
4 digit Electronic substitution Board
2 sides - 2 color leds (red and green)
bag and battery charger included



UEFA
APPROVED



pg.19

Art. D2FE

**Tavoletta elettronica
bifacciale, bicolore DELTA 2FE
completa di valigetta e caricabatteria**
cm. 64,5x39x2,5 kg. 2,8
UEFA Electronic substitution Board
2 sides - 2 color leds
bag and battery charger included



UEFA
APPROVED

UEFA
APPROVED

Art. 065-F

**Tavoletta elettronica approvata UEFA/FIFA
bifacciale, bicolore a 4 cifre DELTA 2F
completa di valigetta e caricabatteria**
led rossi e verdi - cm. 64x39x3 kg. 3
4 digit UEFA/FIFA Electronic substitution
Board 2 sides - 2 color leds (red and green)
bag and battery charger included



COMPRESSORE - POMPE - MANOMETRI Inflator - Pumps - Gauges



Art. 106
Compressore
elettrico 220 Volt
con borsa
Electric Inflator
220 Volt
with bag

pg.19

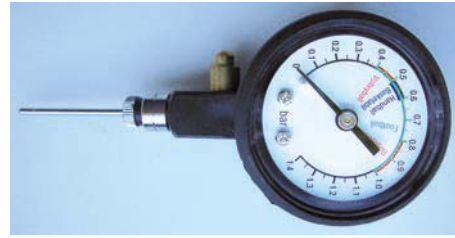

pg.18

Art. 107
Manometro misura pressione palloni con valvola
(con indicazione pressioni consigliate per vari sport)
Pressure Gauge with valve
(with indication of pressure for different sport balls)



Art. US107
Manometro misura pressione palloni alta precisione
con valvola (con indicazione
pressioni consigliate per i vari sport)
High precision pressure Gauge with valve
(with indication of pressure for different sport balls)



Art. 104-A Pompa con ago - Pump with needle

pg.18



Art. PSS
Pompa a staffa
All purpose
Pump



Art. 2005
Confezione 12 Aghi
con valvola
per gonfiatura palloni
Ø filettatura mm.5
Set 12 Needles
with valve
for inflating balls
Ø 5 mm. thread

pg.19

Art. 2005RC
Ago di ricambio
per compressore Art. 106
Ø filettatura mm.7,5
Spare needle
for electric inflator Art. 106
Ø 7,5 mm. thread



Art. 104-T
Pompetta in gomma soft
con ago e valvola di sfiato
ideale per gonfiatura
palloni in gomma
Soft Pump with needle
and valve
for inflating rubber balls

CRONOMETRI - ROTELLE METRICHE - CONTAMETRI Chronometers - Meter Counter - Measuring Tapes

I MODELLI
DEI CRONOMETRI
POSSONO
VARIARE
MODELS MAY
CHANGE

pg.19



Art. CRN.E
Cronometro digitale
1/100 sec.
Digital Chronometer
1/100 sec.



Art. CR032
Cronometro al quarzo
a 30 memorie
resistente all'acqua
Quartz Chronometer
30 memories water resistant



Art. CMT Contametri fino a m. 9999
Meter Counter (until m. 9999)



Art. PR20
Rotella Metrica
in fibra m. 20
Fiber measuring tape 20 m.

Art. PR50
Rotella Metrica
in fibra m. 50
Fiber
measuring tape
50 m.

Art. PR100
Rotella Metrica
in fibra m. 100
Fiber measuring tape 100 m.

PALLONI CALCIO - Soccer Balls



Art. GPA4 / GPA5

Pallone calcio Gems Viper Olimpico da allenamento in PU n. 4 e n. 5

vari colori

Ball Gems in PU size 4 and 5 various colors

pg.19



Art. GPF5

Pallone calcio Gems Viper Olimpico da allenamento in PU n. 5

GIALLO FLUO

Ball Gems in PU size 5 fluorescent yellow

New!



Art. 1000MS4

Pallone calcio da allenamento Molten misto TPU 1000MS n. 4 (Europa League replica)
Molten training ball TPU size 4 (Europa League replica)



Art. 1000MS5

Pallone calcio da allenamento Molten misto TPU 1000MS n. 5 (Europa League replica)
Molten training ball TPU size 5 (Europa League replica)



Art. NKPA4 / NKPA5

Pallone calcio Nike Pitch Team colore bianco o arancio n. 4 e n. 5
Nike training ball size 4 and 5

pg.20



Art. GPRZX

Pallone calcio Gems Raptor ZX da gara FIFA Quality Pro in PU n. 5
Ball Gems in PU size 5



pg.19

Art. F5V48TR

Pallone calcio Molten n. 5 F5V4800 "Trofeo" per allenamento professionisti e gare ufficiali categorie inferiori
Molten Soccer Ball F5V4800 "Trofeo" size 5

PALLONI CALCETTO, DA PALLEGGIO E SPECIALI - Futsal and rubber balls



pg.19

Art. GPPC3
Pallone Gems Bomber
Primi Calci in TPU n. 3
Ball Gems in TPU size 3



pg.20

Art. GBLD
Pallone calcetto Gems
Blade a rimbalzo
controllato n. 4
Futsal Ball Gems size 4



pg.20

Art. GPCV
Pallone calcetto Gems Vertigo
a rimbalzo controllato n. 4
Futsal Ball Gems size 4



Art. M390P
Pallone calcetto Molten
modello F9U2000 UEFA
rimbalzo controllato
Molten Futsal Ball F9U2000



Art. GPC8
Pallone calcio a 8 Gems Raptor C8
in PU n. 4,5
Ball Gems in PU size 4,5



Art. MTHO
Pallone calcetto Molten
modello F9U4800 UEFA
rimbalzo controllato
(Thorax)
Molten Futsal Ball
F9U4800



pg.20

Art. 26854
Pallone feltro indoor n. 4
a rimbalzo normale
Indoor Ball size 4



Art. 45862
Pallone feltro indoor
n. 4 a rimbalzo controllato
Indoor slow rebound
Ball size 4



pg.20

Art. ULT46-3
Pallone calcetto
in gomma TRIAL triplo
strato rimbalzo controllato
gr.380 - diam. cm.19,9
 Futsal Ball slow rebound
 Trial rubber



Art. 1935S
Pallone calcio in gomma
monostrato n. 3
colore giallo
 Rubber soccer Ball
 single stratum size 3
 color yellow



pg.21

Art. BYCC
Pallone calcio bicolore
gomma Trial Ø cm.21,5 gr. 420
 Trial rubber bicoloured ball



Art. V45/V44/V42/V41/V40
Palloni calcio in gomma Trial monostrato n. 1 - 2 - 3 - 4 - 5
(misura 5 solo nel colore bianco)
 Rubber soccer Balls single stratum Trial size 1 - 2 - 3 - 4 - 5
 (size 5 only in white color)

pg.20



Art. ULT42-3/ULT41-3
ULT40-3
Palloni calcio in gomma
Trial triplo strato
n. 3 - 4 - 5
 Rubber soccer Balls
 triple stratum Trial
 size 3 - 4 - 5

Art. ULTST3/ULTST4/
ULTST5
Palloni Trial SILVER
STREET n. 3 - 4 - 5
doppio strato
 SILVER STREET Trial balls
 size 3-4-5 double stratum



Art. TRILO
Pallone calcio Trial
TRILO n. 4,5
doppio strato
limita il trauma dovuto
all'impatto con la palla
 Soccer Ball Trial TRILO
 size 4,5 double stratum
 softens ball contact

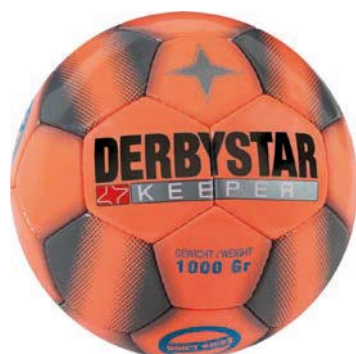

Art. B703390

Pallone in pelle sintetica gr.1000
Training Ball
in synthetic leather 1000 gr.



Art. ULTS40

Pallone in gomma Trial
allenamento potenziato doppio strato
Ø cm.21,5 gr.630 (+50%)
Trial heavy rubber ball double stratum



Art. ULTD40

Pallone in gomma Trial
allenamento potenziato
doppio strato
Ø cm.21,5 gr.840 (+100%)
Trial heavy rubber ball
double stratum

pg.20

pg.21



Art. TRBC

Pallone Reaction Ball Trial
doppio strato rimbalzo e traiettorie
imprevedibili per calcio
Trial Reaction Ball unpredictable
rebounds for soccer double stratum



Art. B703315

Pallone per allenamento portieri
rimbalzo irregolare in pelle sintetica
Crazy Goalkeeper Ball
irregular rebounds in synthetic leather



Art. B703316

Reflex ball
pallone prismatico
in pelle sintetica
Prismatic ball in
synthetic leather



pg.20

Art. 149S14

Pallone in
gommapiuma Ø cm. 14
Foam rubber ball Ø 14 cm.



Art. 149S

Pallone in
gommapiuma Ø cm. 20
Foam rubber ball Ø 20 cm.



pg.21

Art. E48

Pallone sonoro Trial
per non vedenti
Ø cm.22 - gr.470
Trial rattle ball for blind people

PALLE MEDICHE - Medicine Balls



pg.21

Art. AHF-105 / AHF-106 / AHF-107 / AHF-108 / AHF-109

**Palle Mediche
rigonfiabili e rimbalzanti
Kg. 1 - 2 - 3 - 4 - 5
ad alto grip colore nero
Medicine Balls
inflatable and rebounding
high grip in black color**



Art. 048 / 050 / 051 / 052 / 053

**Palle Mediche rigonfiabili
e rimbalzanti Trial
kg. 1 - 2 - 3 - 4 - 5
(il colore varia
a seconda del peso)
Trial Medicine Balls
inflatable and rebounding
different colors for different weights**



Art. PTI.M2 / ... / PTI.M10

**Palle Mediche con maniglie
kg. 2 - 4 - 6 - 8 - 10
(il colore varia
a seconda del peso)
Medicine Balls with handles
different colors for different weights**

Art. AHF-048/.../AHF-097

**SLAM BALL
kg. 2 - 3 - 4 - 5 - 6 - 7 - 8
9 - 10 - 12 - 15**



pg.21 pg.22



Art. AHF-224/.../AHF-232

**WALL BALL
kg. 3 - 4 - 5 - 6 - 7 - 8
9 - 10 - 12**



pg.12

Art. KEB4/KEB6/KEB8/KEB10/KEB12/KEB16/KEB20/KEB24

**Kettlebell in ghisa verniciata con base in gomma
kg. 4 - 6 - 8 - 10 - 12 - 16 - 20 - 24
Painted cast iron Kettlebells - rubber base**

**Art. RVKEB
Rastrelliera verticale
porta kettlebell/
palle mediche
(8 posti)
8-seater vertical rack
for cast iron
Kettlebells/
Medicine Balls**



Art. OV500 / OV1 / OV2 / OV3 / OV4 / OV5
**Over Ball Trial kg.0,5 - 1 - 2 - 3 - 4 - 5
con impugnatura anatomica
Over Ball Trial**

pg.21



**Art. WMD100 / WMD200
WMD300 / WMD400 / WMD500**
**Palle Mediche morbide Bubble
Trial - kg. 1 - 2 - 3 - 4 - 5
Soft Trial Medicine Bubble Balls
kg. 1 - 2 - 3 - 4 - 5**



New!

Art. SKN05 / SKN1 / SKN2 / SKN3 / SKN4 / SKN5

Palle mediche SKIN BALL riempite con acqua demineralizzata colorata - peso kg. 0,5-1-2-3-4-5

SKIN BALL Medicine balls filled with demineralized coloured water - weight 0,5-1-2-3-4-5 Kg.

pg.21

Grazie a queste nuove palle mediche gli atleti utilizzano carichi non inerti ma dinamici, effettuando esercizi di forza coordinata nuovi e destabilizzanti. La massa oscillante all'interno della palla medica SKIN BALL impone, sia in fase di lancio che di carico, adattamenti muscolari e coordinativi istantanei la cui intensità è variabile, e quindi non prevedibile. Inoltre, per i più giovani le palle mediche SKIN BALL sono molto efficaci per la memorizzazione della tecnica e per migliorare la conoscenza ed il controllo del proprio corpo. È possibile gonfiare e sgonfiare tutte le SKIN BALL variandone così la sofficietà

The new SKIN BALL medicine balls allow new exercises for muscle strength, equilibrium and coordination.

The liquid inside these balls makes them dynamic weights that require new rapid and adapting movements both when throwing and when lifting. Younger players will also improve and memorize body movements enhancing their equilibrium. These balls can be inflated or deflated so that softness will change

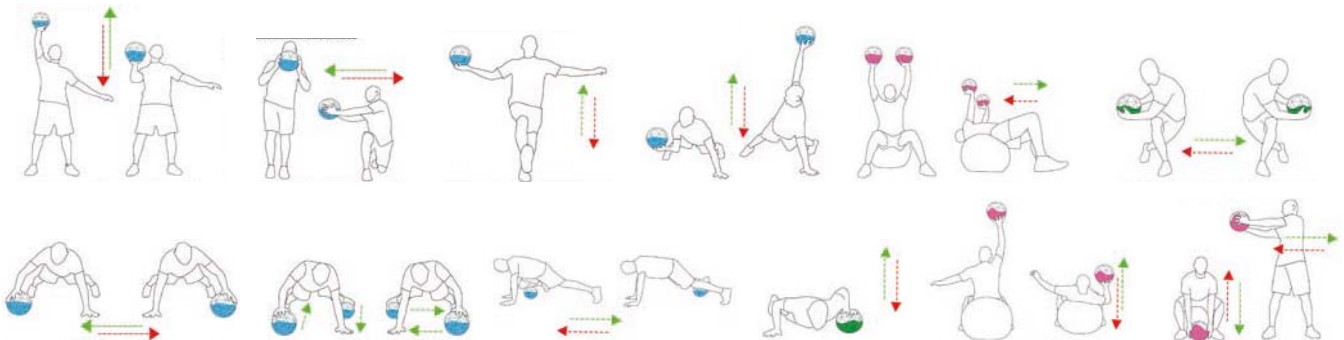

Con le palle mediche SKIN BALL è possibile effettuare un allenamento dinamico utile per il rafforzamento degli arti inferiori e superiori, e per migliorare l'abilità nel lancio e nella presa

With SKIN BALL you can run a dynamic training good for strengthening the lower and upper limbs, and to increase the ability of making throws and holds

Art. POL1 / POL1.5 / POL2 / POL3 / POL3.5

POLIBOLO - Over Ball Trial a massa oscillante (riempite con acqua distillata) peso kg.1 - 1,5 - 2 - 3 - 3,5

POLIBOLO - Over Ball Trial filled with distilled water - weights 1 - 1,5 - 2 - 3 - 3,5 Kg.



Le Over Ball e le Polibolo possono essere utilizzate sia come manubri sia come palle mediche

Over Balls and Polibolos can be used both as dumb bells and medicine balls

PALLE RITMICHE, PSICOMOTORIE E LUDICHE - Rhythmic and Gym Balls



Art. GS42/GS41/GS40/GS39 Palle Ritmiche Trial - Trial Rhythmic Balls gr. 400-350-250-150



**Ideali per trattamento
fisioterapico,
equilibrio, stretching,
tonificazione, attività
aerobica, scarico
vertebrale,
riscaldamento,
potenziamento
muscolare ...**

Very useful for injury
recovery, equilibrium,
stretching, muscle
training, aerobic activity,
warm up ...



Art. 30934/30935/30936/31036

Palle psicomotorie monostrato

Gym balls single stratum

Ø cm. 55

Ø cm. 65

Ø cm. 75

Ø cm. 85

**Art. V10/V11/V12/V13/V14/V15/
V16/V17/V18/V19**

Palle psicomotorie Trial in gomma doppio strato (il colore varia a seconda del diametro)

Trial Gym balls
in double stratum rubber

Ø cm.14-18-22-30

42-53-65-90-120-150



● pg.22

Art. V-LAB

Palla psicomotoria Trial La Ball con range di possibile utilizzo da cm.50 a cm.70 struttura instabile in gomma doppio strato particolarmente elastica

Gym ball Trial La Ball
inflatable from 50 to 70 cm.

changing shape

concept in very elastic

double stratum rubber



Art. ULTbbs3
Pallone Jumbo Trial a 3 strati
 diam. cm.28 - gr.280
 Jumbo Trial Ball triple stratum

pg.21



Rimbalzo normale con diametro maggiorato per favorire l'apprendimento del bambino
 Normal rebound with bigger diameter for youngest training and fun



Art. BTR1

Palla sensoriale Ø cm. 21 - gr. 420
 Sensory Ball Ø cm.21 - gr. 420

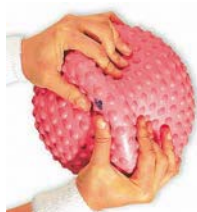

Le palle sensoriali rimbalzanti esaltano la tattilità e rappresentano anche uno strumento di automassaggio a pressione
 To stimulate touch and also useful massage tools



Art. BTR2

Palla sensoriale Ø cm.12 - gr. 180
 Sensory Ball Ø cm.12 - gr. 180

pg.20

Allenando la visibilità laterale migliorano la percezione dello spazio, i movimenti e la sicurezza nella vita quotidiana
 For space perception, coordination and everyday life safety

pg.8



Art. TLV16

Palle morbide Trial per allenamento della visibilità laterale Set di 6 Palle diametro cm. 16 gr. 110
 Soft balls for lateral visibility training Set of 6 balls
 16 cm. diameter - 110 gr.

Art. TLV21

Set di 6 Palle diametro cm. 21 gr. 160
 Soft balls for lateral visibility training Set of 6 balls
 21 cm. diameter - 160 gr.



Art. BS1T

PALLONE BASIC jelly touch
 Ø 12/16 cm. gr.140 - colore verde
 Basic Ball green color

Art. BS2T

PALLONE BASIC jelly touch
 Ø 16/22 cm. gr.180 - colore arancio
 Basic Ball orange color

Art. BS3T

PALLONE BASIC jelly touch
 Ø 22/28 cm. gr.240 - colore rosso
 Basic Ball red color

pg.21

BORSE - Bags

**QUANTITÀ PER MODELLO
E COLORE MULTIPLA DI 5 PEZZI**
Quantity by model and color
multiple of 5 pieces

COLORI DISPONIBILI
rosso, royal, navy (no Small),
nero, verde, bordeaux
Colors: red, royal, black,
green, navy (no Small),
bordeaux



Art. STD02
Borsa Big
doppio fondo
cm. 53,5x45h.x32,5
poliestere 600
Soccer bag large

Art. STD09
Borsa Medium
doppio fondo
cm. 50x42h.x30
poliestere 600
Soccer bag medium

Art. STD03
Borsa Small
doppio fondo
cm. 47,5x40h.x26,5
poliestere 600
Soccer bag small

pg.23

**QUANTITÀ PER COLORE
MULTIPLA DI 5 PEZZI**
Quantity by color
multiple of 5 pieces



Art. STD04
Borsa TOP bicolore in poliestere 600 con fondo
rigido h. 15 cm. con tracolla e porta nome,
tre tasche, dim. cm. 53,5x45h.x32,5
colori: navy/royal, nero/grigio, navy/rosso,
nero/verde, navy/giallo, nero/rosso, nero/bordeaux
Soccer Bag bicolor in polyester 600 1 pocket
size 53,5x45h.x32,5 cm.
colors: navy/royal, black/grey, navy/red, black/green,
navy/yellow, black/red, black/bordeaux

**QUANTITÀ PER COLORE
MULTIPLA DI 15 PEZZI**
Quantity by color
multiple of 15 pieces



Art. STD18
Zainetto doppio fondo poliestere 600
2 tasche - cm. 34x47h.x24 fondo rigido
colori: royal, nero, rosso,
navy, verde, bordeaux
Rucksack in 6 different colors



Art. STD05
Borsa Portamute cm. 72x35h.x28
poliestere 600 - colore nero
Soccer bag for uniforms dim. 72x35h.x28 cm.
color black

QUANTITÀ PER COLORE
MULTIPLA DI 5 PEZZI

Quantity by color
multiple of 5 pieces

pg.23



Art. STD08
Borsa palestra poliestere 600 cm.60x30h.x32
con due tasche e vano portascarpe
colori rosso, royal, navy, nero
Gym Bag color black, red, royal, navy



Art. ZBGL
BORSA/ZAINETTO monocolore economica
cm. 36x38 vari colori - serigrafabile su richiesta
Backpack one color with your logo on request



Art. STD07
Borsa Medica dim. cm. 40x28,5h.x20
poliestere 600 - colore nero
Bag for First Aid 40x28,5h.x20 cm.



Art. BMD
Borsa Medica dim. cm. 37x29h.x17
Bag for First Aid 37x29h.x17 cm.

CESTE PORTAPALLONI - Baskets for balls



Art. FP400

Cesta portapalloni a soffietto in alluminio
cm. 60x60x100h pieghevole con sacca
 Basket for balls in aluminium
 60x60x100h cm. foldable with bag



Art. F401

Cesta Portapalloni in ferro verniciato
cm. 80x55x60h pieghevole
 Basket for Balls in painted steel 80x55x60h cm. foldable



pg.22

Art. F402

Cesta Portapalloni
in ferro zincato
cm. 60x60x90h pieghevole
 Basket for Balls
 in galvanized steel
 60x60x90h cm. foldable

Art. F404 Cesta Portapalloni
in rete metallica verniciata
cm. 70x70x70h pieghevole
con lucchetto
 Basket for Balls
 painted with metallic net
 70x70x70h cm.
 foldable, with lock



Art. F403G Cesta Portapalloni
in ferro verniciato cm. 100x75x90h
pieghevole con lucchetto
 Basket for Balls in painted steel
 100x75x90h cm. foldable, with lock



pg.22



pg.23

Art. NCPR

Sacca portapalloni in nylon
con maniglie, tracolla e ruote
 Bag for balls with handles and wheels

Art. F403ZN
Cesta Portapalloni in ferro zincato
cm. 100x75x90h
pieghevole con lucchetto
 Basket for Balls in galvanized steel
 100x75x90h cm. foldable, with lock



PORTE CALCIO - Soccer Goals



Art. 109

Coppia Porte fisse regolamentari in lega leggera costruite secondo lo standard europeo di qualità UNI EN 748 con paletti tendirete posteriori in acciaio zincato, pali sezione mm. 120x100 verniciati con smalto acrilico non tossico, ganci reggirete e bussole per interrimento pali incluse (ribaltine alzarete non incluse)

Pair of regular Goals in light alloy manufactured according to the UNI EN 748 European standard of quality norms. Pipe section 120x100 mm. painted with non toxic white. Net holders, rear posts and underground sockets included (liftable ground backframes not included)

pg.23

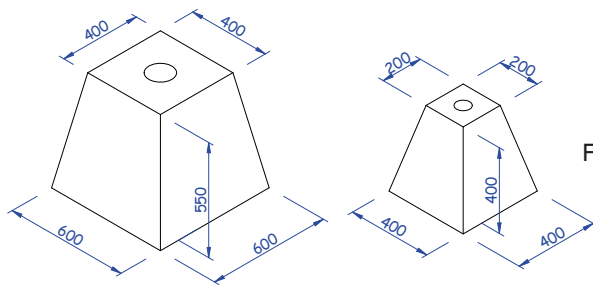

Ancoraggio tramite plinti in cemento (non inclusi)

Fixing with concrete blocks (not included)

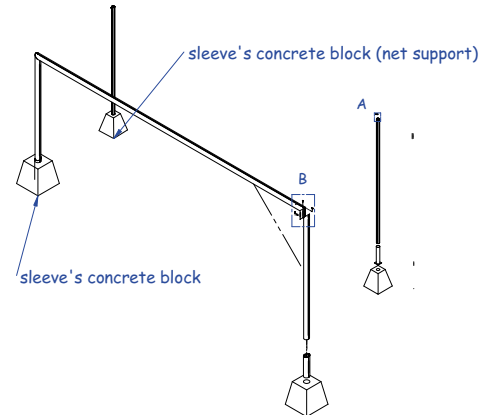

ATTENZIONE: in caso di ordine errato da parte del Cliente le porte, una volta consegnate, non possono essere rese

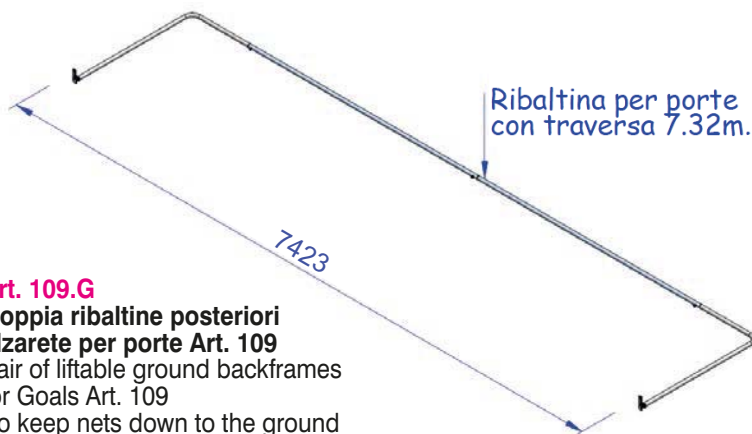

Art. 109.G

Coppia ribaltine posteriori alzarete per porte Art. 109

Pair of liftable ground backframes for Goals Art. 109 (to keep nets down to the ground and also to raise them up when cutting grass)

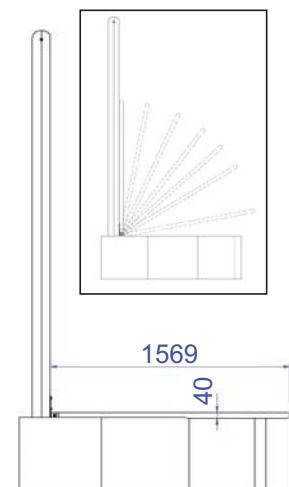

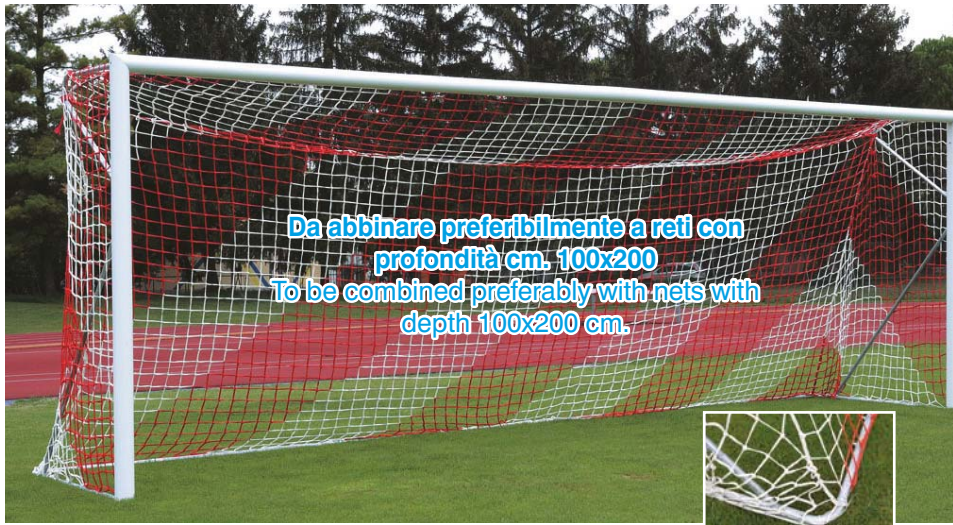

Art. 120-RG
Coppia ruote per porte trasportabili regolamentari Art. 110FG, 110-D e 110G
Pair of wheels for regular size transportable goals Art. 110FG, 110-D and 110G

Art. 110FG Coppia Porte Trasportabili in lega leggera dimensioni regolamentari profilo sezione mm. 120x100 verniciate con smalto acrilico non tossico base di appoggio posteriore con tubo tondo in ferro - a norma UNI EN 748
Pair of transportable Goals in light alloy regular size, pipe section mm. 120x100 painted with non toxic white - back frame in round iron pipe - UNI EN 748 standard



LE PORTE TRASPORTABILI IN FASE DI GIOCO DEVONO ESSERE ZAVORRATE SULLA BASE POSTERIORE O FISSATE A TERRA CON PICCHETTI PER MOTIVI DI SICUREZZA. LE RUOTE GOMMATE SONO OPTIONAL

Transportable goals must always be anchored to the ground by sacs of sand or metal pegs, for safety reasons. Wheels are optional

Art. 110-D
Coppia Porte Trasportabili dim. regolamentari in lega leggera profilo sezione mm. 120x100 - verniciate con smalto acrilico non tossico base di appoggio posteriore con profilo ovale in alluminio mm. 65x55 - a norma UNI EN 748
Pair of transportable Goals in light alloy regular size, pipe mm. 120x100 painted with non toxic white - back frame in aluminium ovoidal pipe 65x55 mm.



Art. AMCP
Carrello per il trasporto di porte (trasportabili) regolamentari e ridotte - brevettato
Patented trolley for moving official and junior size transportable goals

● pg.26



Art. 110G Coppia Porte Trasportabili in lega leggera dimensioni regolamentari profilo mm. 120x100 verniciate con smalto acrilico non tossico, base di appoggio posteriore con profilo in lega mm. 120x100 - a norma UNI EN 748 e FIGC
 Pair of transportable Goals in light alloy regular size, pipe mm. 120x100, painted with non toxic white - back frame pipe 120x100 mm. - UNI EN 748 and FIGC standard

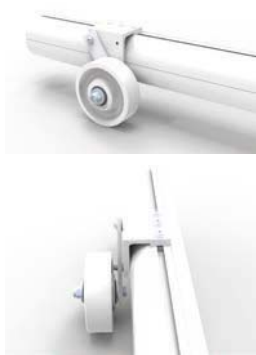

Art. 110GMR Set 4 ruote per porte trasportabili regolamentari Art. 110G (2 set per 1 coppia di porte). Ciascuna ruota in dotazione ha una posizione di riposo e una posizione di trasporto (per passare dall'una all'altra occorre far ruotare il dispositivo intorno al perno). Dunque, le ruote restano sempre fissate al telaio posteriore della porta
 Set of 4 wheels for regular size transportable goals Art. 110G (2 set for 1 pair of goals). Each wheel remains fixed to the back ground frame also when goals are in use, in stand by position. To switch the wheel into transport position you have to turn it around the pivot

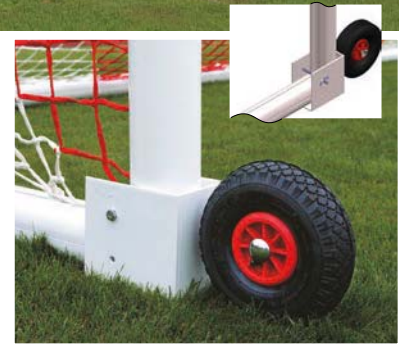

pg.24

Art. 120-RG
 Coppia ruote per porte trasportabili regolamentari Art. 110FG, 110-D e 110G
 Pair of wheels for regular size transportable goals Art. 110FG, 110-D and 110G

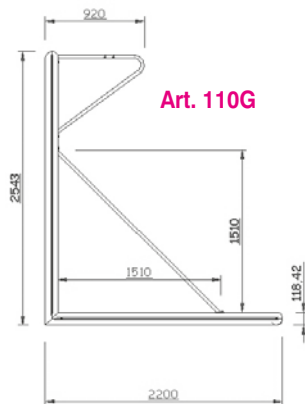

Art. 110G

Art. 4580M
 Mollone per ancoraggio porte trasportabili regolamentari e ridotte su terreno naturale
 Spring for goal anchoring on natural grass

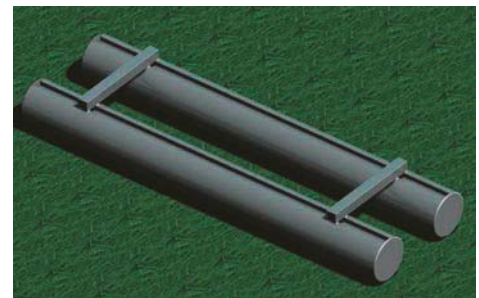

Art. AFC
 Zavorra in alluminio per ancoraggio porte trasportabili regolamentari e ridotte
 Aluminium weighted pipes for goal anchoring

ATTENZIONE: in caso di ordine errato da parte del Cliente le porte, una volta consegnate, non possono essere rese

Art. DSSCE
 Sacco zavorra vuoto (da riempire con sabbia) per ancoraggio porte trasportabili regolamentari e ridotte
 Empty Ballast Bag (to be filled with sand) for goal anchoring

pg.26



Art. DSS20
 Sacco zavorra kg. 20 (riempito con sabbia) per ancoraggio porte trasportabili regolamentari e ridotte
 Ballast Bag weight 20 Kg. for goal anchoring

Porte fisse (con bussole e pali da interrare) e trasportabili in lega leggera o acciaio, sezione tubo mm. 120x100 o mm.80 - dimensioni m. 3x2 - m. 4x2 - m. 5x2 - m. 6x2
 Fixed and transportable Goals in light alloy or painted steel, pipe section 120x100 mm. or 80 mm. dimensions m. 3 x 2 - m. 4 x 2 - m. 5 x 2 - m. 6 x 2

pg.24 pg.25

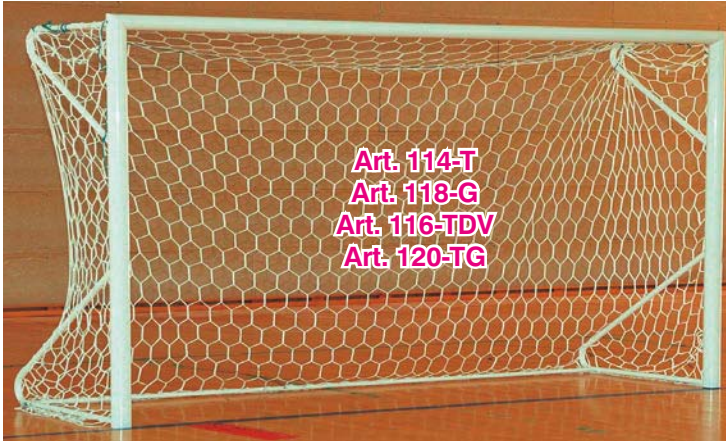

Art. 114-T
 Art. 118-G
 Art. 116-TDV
 Art. 120-TG

Con distanziale a terra posteriore in tubo tondo
 With round pipe ground base

ATTENZIONE: in caso di ordine errato da parte del Cliente le porte, una volta consegnate, non possono essere rese

Art. 114-T

Coppia Porte m. 4 x 2 a traversa intera in acciaio trasportabili tubo sezione 80 mm.
 Pair of Goals m. 4 x 2 - 1 piece crossbar in painted steel, transportable, pipe 80 mm.

Art. 118-G

Coppia Porte m. 4 x 2 a traversa intera in lega di alluminio trasportabili tubo sezione 80 mm.
 Pair of Goals m. 4 x 2 - 1 piece crossbar in light alloy, transportable, pipe 80 mm.

Art. 116-TDV

Coppia Porte m. 5 x 2 a traversa divisa in lega di alluminio trasportabili tubo 80 mm.
 Pair of Goals m. 5 x 2 - crossbar in 2 pieces in light alloy, transportable, pipe 80 mm.

Art. 120-TG

Coppia Porte m. 6 x 2 a traversa divisa in lega di alluminio trasportabili tubo sezione 80 mm.
 Pair of Goals m. 6 x 2 - crossbars in 2 pieces in light alloy, transportable, pipe 80 mm.

Art. 118A
Coppia Porte m. 4 x 2 a traversa divisa in lega di alluminio trasportabili tubo 80 mm. con base posteriore a sezione quadra
 Pair of Goals m. 4 x 2 - crossbars in 2 pieces in light alloy, transportable, pipe 80 mm. with square pipe ground bases

Art. 1129A
Coppia Porte m. 5 x 2 a traversa divisa in lega di alluminio trasportabili tubo 80 mm. con base posteriore a sezione quadra
 Pair of Goals m. 5 x 2 - crossbars in 2 pieces in light alloy, transportable, pipe 80 mm. with square pipe ground bases

Art. 1121A
Coppia Porte m. 6 x 2 a traversa divisa in lega di alluminio trasportabili tubo 80 mm. con base posteriore a sezione quadra
 Pair of Goals m. 6 x 2 - crossbars in 2 pieces in light alloy, transportable, pipe 80 mm. with square pipe ground bases



Art. 118A
 Art. 1129A
 Art. 1121A

Da abbinare esclusivamente a reti con profondità cm. 100x160
 To be combined only with nets with depth 100x160 cm.

Base posteriore a sezione quadra
 Reinforced ground base

LE PORTE TRASPORTABILI IN FASE DI GIOCO DEVONO ESSERE ZAVORRATE SULLA BASE POSTERIORE O FISSATE A TERRA CON PICCHETTI PER MOTIVI DI SICUREZZA. LE RUOTE GOMMATE SONO OPTIONAL
 Transportable goals must always be anchored to the ground by sacs of sand or metal pegs, for safety reasons. Wheels are optional



Art. 120-R
Coppia ruote per porte trasportabili ridotte Art. 118A, 1129A, 1121A
 Pair of wheels for reduced size transportable goals Art. 118A, 1129A, 1121A

pg.25



Art. 4640
Coppia ruote per porte trasportabili ridotte Art. 114-T, 118-G, 116-TDV, 120-TG
 Pair of wheels for reduced size transportable goals Art. 114-T, 118-G, 116-TDV, 120-TG



Le porte ridotte sono disponibili anche nel modello fisso con bussole e pali da interrare
 Available also fixed models with underground sockets



Art. 119G
Art. 120-G

Da abbinare esclusivamente a reti con
profondità cm. 100x160
To be combined only with nets with
depth 100x160 cm.

Art. 119G Coppia Porte m. 5 x 2 a traversa divisa
in acciaio trasportabili tubo 80 mm.
Pair of Goals m. 5 x 2 crossbar in 2 pieces in painted steel,
transportable, pipe 80 mm.

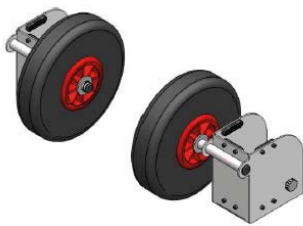

Art. 240RU Coppia ruote
gommate con staffa per porte
Art. 119G/120-G
Pair of wheels for transportable
goals Art. 119G/120-G



Art. 240AF Kit di fissaggio a
terra per porte Art. 119G/120-G
Ground anchoring kit for
transportable goals
Art. 119G/120-G

Art. 120-G Coppia Porte m. 6 x 2 a traversa divisa
in acciaio trasportabili tubo sezione 80 mm.
Pair of Goals m. 6 x 2 crossbars in 2 pieces
in painted steel, transportable, pipe 80 mm.

pg.24 pg.25

Art. 241C Chiave per kit
di fissaggio Art. 240AF
Key for ground anchoring
kit Art. 240AF



ATTENZIONE:
in caso di ordine errato da parte del Cliente
le porte, una volta consegnate,
non possono essere rese



Art. 122G
Art. 121G

Art. 122G
Coppia Porte Calcetto m. 3 x 2 trasportabili
in acciaio verniciato tubo sezione 80 mm.
Pair of Goals m.3x2 transportable in painted steel pipe 80 mm.

Art. 121G
Coppia Porte Calcetto m. 3 x 2 trasportabili
in lega leggera tubo sezione 80 mm.
Pair of Goals m.3x2 transportable in light alloy pipe 80 mm.

pg.25

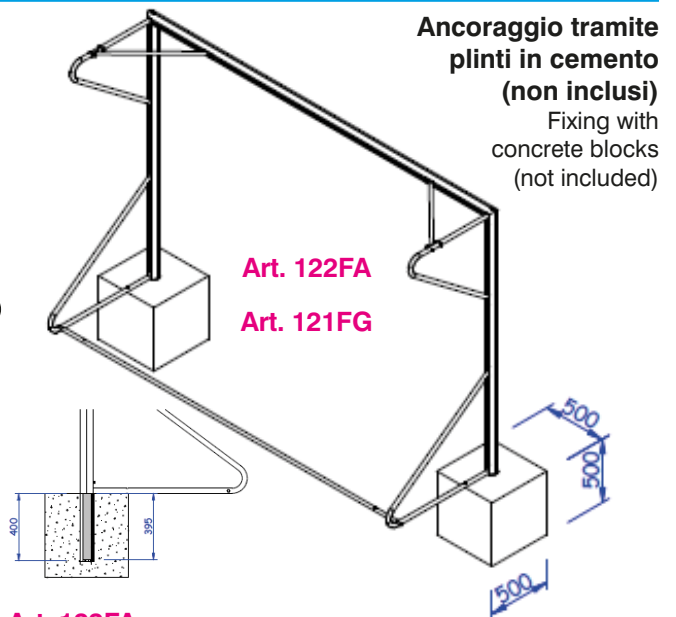

**Ancoraggio tramite
plinti in cemento
(non inclusi)**
Fixing with
concrete blocks
(not included)

Art. 122FA
Coppia Porte Calcetto m. 3 x 2 fisse con bussole da
interrare in acciaio verniciato tubo 80 mm.
Pair of Goals m.3x2 fixed in painted steel pipe 80 mm.

Art. 121FG
Coppia Porte Calcetto m. 3 x 2 fisse con bussole da
interrare in lega leggera tubo 80 mm.
Pair of Goals m.3x2 fixed in light alloy pipe 80 mm.

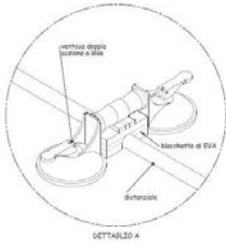

Art. VTCL
Ventosa doppia per ancoraggio a terra
porte calcetto su superfici indoor lisce
(si consigliano 2 kit per ciascuna porta)
 Ground anchoring suckers for reduced goals
 to be used upon indoor smooth floors
 (it takes 2 kits for every goal)

pg.25 pg.26



Art. DSSCE
Sacco zavorra vuoto
(da riempire con sabbia)
per ancoraggio
porte trasportabili
regolamentari e ridotte
 Empty Ballast Bag
 (to be filled with sand)
 for goal anchoring



Art. DSS20
Sacco zavorra kg. 20
(riempito con sabbia)
per ancoraggio
porte trasportabili
regolamentari e ridotte
 Ballast Bag weight 20 Kg.
 for goal anchoring

Art. PC04
Picchetto in alluminio
per ancoraggio
di porte ridotte
con distanziale sottile
su terreno naturale
 Aluminium anchoring hook
 for reduced soccer goals
 with thin pipe ground bases

Art. AM01.7/.../AM01.3
TUBO ZAVORRA in PVC diametro 50 mm. atossico,
flessibile, modellabile, appesantito da composto
ecologico (peso 6 Kg. per metro) resistente alle alte e
basse temperature e ai raggi ultravioletti
per porte ridotte mt. 3x2/4x2/5x2/6x2
e regolamentari sia fisse che trasportabili
 Weighted soft Pipe 50 mm. diameter
 (6 Kg. per meter) resistant to high/low
 temperatures and ultra violet rays
 for safe anchoring of transportable goals
 m. 3x2/4x2/5x2/6x2 and official size goals
 to the ground

pg.26



Art. 353.G10 (modello 2010)



Art. 353.G13 (modello 2013)

Art. 353.G10 / 353.G13
Serie 100 ganci reggirete di
ricambio modello a rotazione
per porte regolamentari o ridotte
 100 spare Net Holders
 rotating model for regular
 and reduced goals



pg.25

Art. 353 Serie 100 ganci reggirete
di ricambio modello con vite per porte
regolamentari o ridotte
 100 spare Net Holders with screws
 for regular and reduced goals



Art. V590010
Serie 100 ganci
reggirete
di ricambio
 100 spare
 Net Holders



Art. V680011 Serie 100 ganci
reggirete di ricambio
a base rotonda da fissare con viti
 100 spare Net Holders

ATTENZIONE: verificate la tipologia dei ganci
delle Vostre porte prima di ordinare i ricambi
 Please check the model of your holders
 before ordering spares



Art. GFG
Gancio
reggirete
in ferro con
piastrina
di ricambio
 Spare iron
 Net Holder



Art. SC1051
Serie 100 ganci
reggirete
di ricambio
 100 spare
 Net Holders



Art. 110BAG
Serie 60 ganci
reggirete
di ricambio
 60 spare
 Net Holders



pg.25

Ideale per uso
privato
Not for official
matches

Art. SG176

**Porta m. 3x2 trasportabile
in ferro verniciato,
tubo sezione mm. 32
completa di rete, ganci e
picchetti**

3x2 meter transportable
Goal in painted iron, pipe
section 32 mm. complete
with net and anchor pegs



pg.25

Ideale per uso
privato
Not for official
matches

Art. 500SG

**Porta m. 3x2 trasportabile
in ferro verniciato,
tubo sezione mm. 50
completa di rete, ganci e
picchetti**

3x2 meter transportable
Goal in painted iron, pipe
section 50 mm. complete
with net and anchor pegs

**ATTENZIONE: in caso di ordine errato da parte del Cliente
le porte, una volta consegnate, non possono essere rese**

PORTE BIFRONTALI in lega leggera o acciaio dimensioni m. 3x2 - 4x2 - 6x2

Available 2 SIDE GOALS in light alloy or in painted steel dimensions m. 3 x 2 - 4 x 2 - 6 x 2

pg.26



Art. 084

**Porta bifrontale
m. 4 x 2
in lega leggera
sezione tubo 50 mm.
completa di rete**

Two Side Goal
4 x 2 m. in light alloy
pipe 50 mm.
net included

Art. 084AC

**Porta bifrontale
m. 4 x 2
in acciaio verniciato
sezione tubo 50 mm.
completa di rete**

Two Side Goal
4 x 2 m. in painted
steel, pipe 50 mm.
net included

MINI PORTE Mini-goals



Art. F214
Coppia Miniporte professionali
in acciaio verniciato tubo sezione 80 mm.
dimensioni m. 1,5 x 1 complete di reti
Pair of professional steel Mini-goals
pipe 80 mm. dimensions m. 1,5 x 1
nets included



pg.26

Art. F218
Coppia Miniporte professionali
in acciaio verniciato
tubo sezione 80 mm.
dimensioni cm. 90x60
complete di reti
Pair of professional steel Mini-goals
pipe 80 mm.
dimensions 90x60 cm.
nets included



Art. 123C
Coppia Miniporte in acciaio verniciato m. 1,5 x 1
complete di reti e picchetti
Pair of Mini-goals m. 1,5 x 1
in painted steel pegs and nets included



Art. 123F
Coppia Miniporte in acciaio verniciato
m. 1,5 x 1 complete di reti e picchetti
Pair of Mini-goals m. 1,5 x 1 in painted steel
pegs and nets included

pg.26



Art. 124C
Coppia Miniporte m. 1,5 x 1,1 in PVC rinforzato tubo Ø 70 mm. complete di reti e picchetti
Pair of PVC Mini-goals m. 1,5 x 1,1 pipe Ø 70 mm. pegs and nets included



Art. 124
Coppia Miniporte in polipropilene m. 1,5 x 1,1
tubo Ø 40 mm. complete di reti
Pair of polypropylene Mini-goals m. 1,5 x 1,1
pipe Ø 40 mm. - nets included



Dimensioni porta ribaltata m. 1,5 x 0,80
Goal upside down dimensions 1,5 x 0,80 m.



Art. A124
Coppia Miniporte in alluminio m. 1,5 x 1,1
tubo Ø 32 mm. complete di reti
Pair of aluminium Mini-goals m. 1,5 x 1,1
pipe Ø 32 mm. - nets included



Dimensioni porta ribaltata m. 1,5 x 0,80
Goal upside down dimensions 1,5 x 0,80 m.

pg.26



Art. PUG
Coppia Miniporte in nylon
m. 1,83 x 1,07
complete di reti,
picchetti e borsa
Pair of nylon Mini-goals
1,83 x 1,07 m.
nets, pegs and bag included



Art. IS215
Miniporta in acciaio m. 2,15 x 1,52 completa di rete, parete con bersagli e rete di rimbalzo
Steel Mini-goal m. 2,15 x 1,52 - net, PVC target and rebounding net included

MINIPORTA CM.150x90 PIEGHEVOLE - Foldable 150x90 cm. mini-goal



New!

pg.26

Art. BG150

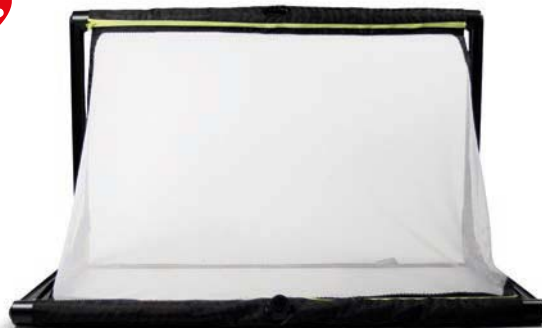

Questa miniporta da calcio pieghevole consente ad allenatori e giocatori di concentrarsi sugli esercizi fondamentali poiché per il montaggio sono richiesti solo 10 secondi. Il telaio facilmente trasportabile è durevole, sicuro e realizzato con una struttura in PVC resistente al calore. Esso è dotato di bobine progettate per tornare in posizione dopo una pallonata e, soprattutto, la porta rimane stabile senza necessità di ancoraggio a terra grazie al sistema a molla integrato.

A differenza di molte porte da calcio in metallo comunemente usate, questa miniporta in PVC è totalmente sicura e previene il rischio di infortuni qualora un giocatore andasse a sbatterci contro.

La rete della porta a tecnologia telescopica brevettata può essere personalizzata. È possibile infatti stamparvi il logo della propria squadra di modo che la porta diventi un utile strumento di marketing per le società sportive, ma anche per i partners esterni delle società stesse che desiderano investire in sponsorizzazioni smart.

La miniporta da calcio pieghevole può essere utilizzata sulle diverse tipologie di superfici (erba, sabbia, cemento, legno). Non ha bisogno di borsa dato che la sua resistente rete funge anche da rivestimento.

La miniporta da 150 cm x 90 cm si riduce ad una dimensione compatta di 180 cm x 15 cm x 10 cm, e le comode cinghie rendono il trasporto agevole visto che il peso è di soli 7 chilogrammi.

Le miniporte da calcio pieghevoli vengono utilizzate quotidianamente presso alcune delle più rinomate accademie e scuole calcio di club professionistici tra cui Chelsea, Barcellona, Ajax, Arsenal, Manchester United, Liverpool ed Everton. Sono approvate e raccomandate dalla Federcalcio catalana in Spagna, dalla Federazione norvegese, nonché dall'Oregon Youth Soccer Association.



**SI INSTALLA
IN 10 SECONDI
READY IN 10
SECONDS**

**LEGGERA E
COMODA PER
IL TRASPORTO
LIGHT AND
COMFORTABLE
FOR TRANSPORT**

**CON RETE
PERSONALIZZABILE
WITH
CUSTOMIZABLE
NET**



This foldable mini-goal allows coaches and players to focus on core exercises as only 10 seconds are required for assembly. The easily transportable frame is durable, safe and made with a heat resistant PVC construction. It's equipped with coils designed to return to position after a ball hit and, above all, the goal remains stable with no need to be anchored to the ground thanks to the integrated spring system.

Unlike many commonly used metal soccer goals, this PVC mini-goal is totally safe and prevents the risk of injury should a player bump into it.

The patented telescopic goal net can be customized. In fact, it's possible to print the logo of your team so that the goal becomes a useful marketing tool for sports clubs, but also for external partners who wish to invest in smart sponsorships.

The foldable mini-goal can be used on different surfaces (grass, sand, concrete, wood). It does not need a bag as its durable net also acts as a covering.

The 150 cm x 90 cm mini-goal is reduced to a compact size of 180 cm x 15 cm x 10 cm, and the comfortable straps make transport easy as the weight is only 7 kilograms.

Foldable mini-goals are used daily at some of the most renowned academies and soccer schools of professional clubs including Chelsea, Barcelona, Ajax, Arsenal, Manchester United, Liverpool and Everton. They are approved and recommended by the Catalan Football Association in Spain, the Norwegian Federation, as well as the Oregon Youth Soccer Association.



RETI REGOLAMENTARI - Regular Nets

Le reti a maglia esagonale sono tessute, quelle a maglia quadrata sono annodate (eccetto Art. B011)
 Square mesh nets are knotted (except Art. B011)



Art. B011
 polipropilene mm.5
 maglia mm.120 mesh
 colore bianco
 white
 certificate FIGC/LND
 certified
 profondità
 cm.200x200 depth

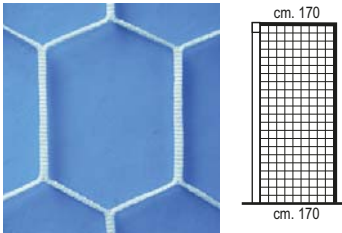
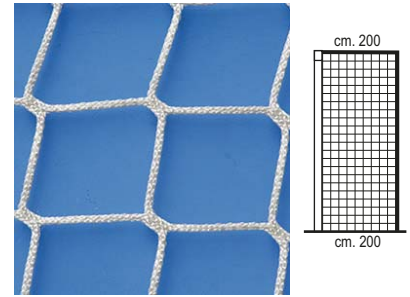

Art. 125E
 polipropilene mm. 3
 profondità
 cm.170x170 depth

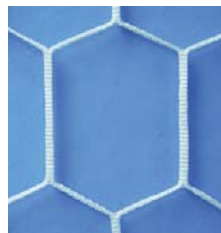

Art. 125
 polipropilene mm. 4
 profondità
 cm.170x170 depth

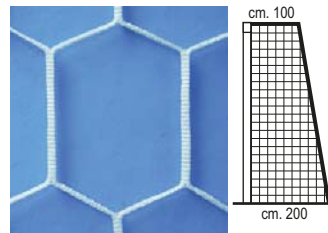

Art. 126
 poliestere mm. 5
 profondità
 cm.100x200 depth

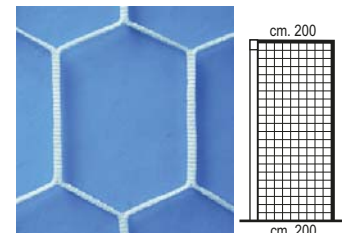

Art. 127
 polipropilene mm. 5
 profondità
 cm.200x200 depth

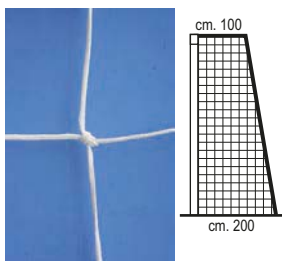

Art. B19
 polietilene sp.mm.3,5
 profondità
 cm.100x200 depth

pg.27



Art. 128E
 polietilene sp.mm.3,5
 profondità
 cm.200x200 depth

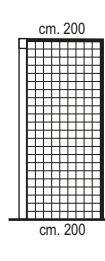

Art. 128
 polietilene sp.mm.4,5
 profondità
 cm.200x200 depth



Profondità:
 la prima grandezza indica
 la sporgenza posteriore
 della rete
 ad altezza traversa,
 la seconda grandezza
 indica quella a terra
 Depth: the first figure indicates
 the rear depth of the net at
 crossbar level, the second
 figure indicates the rear depth
 at ground

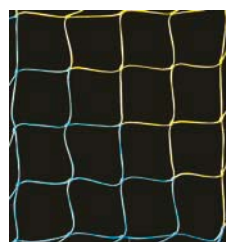

Art. 128FR Coppia reti annodate in polietilene mm.4 bianche o a strisce colorate (bianco-royal, bianco-rosso, giallo-royal) profondità cm.100x200 depth
 Pair of nets polyethylene 4 mm. color stripes, knotted (available in white, white-royal, yellow-royal, white-red)

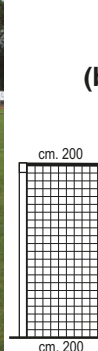
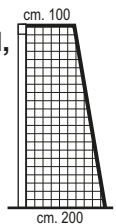

Art. 128C Coppia reti annodate in polietilene mm.3,5 a strisce colorate (bianco-royal, bianco-rosso, giallo-royal, rosso-blu, bianco-nero, bianco-verde) profondità cm.200x200 depth
 Pair of nets polyethylene 3,5 mm. color stripes, knotted (available in white-royal, yellow-royal, white-red, white-black, white-green, red-blue)



Art. 129T
 Coppia reti polipropilene mm.4 annodate a mano a strisce colorate (consigliabile per combinazioni di colori alternative a quelle degli Art.128FR e 128C) profondità cm.200x200 depth
 Pair of nets with color stripes, hand knotted in various combinations



RETI RIDOTTE - Reduced Size Nets - m.4x2/m.5x2/m.6x2/m.6x2,2/m.6,5x2,5

Profondità: la prima grandezza indica la sporgenza posteriore della rete ad altezza traversa, la seconda grandezza indica quella a terra

Depth: the first figure indicates the rear depth of the net at crossbar level, the second figure indicates the rear depth at ground

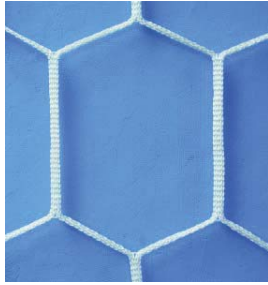

Art. 133
Coppia Reti
m. 4x2
in polipropilene
mm. 4
profondità
cm.120x120
Pair of nets 4x2 m.
Polipropilene
mm. 4 thickness
cm.120x120 depth

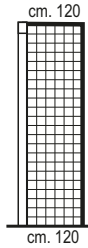

Art. 133SN
Coppia Reti m. 4x2
annodate in
polietilene mm. 2,5
profondità
cm.100x100
Pair of knotted nets
4x2 m.
polietilene thickness
2,5 mm.
cm.100x100 depth

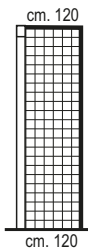
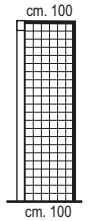

Art. 133LR
Coppia Reti m. 4x2
annodate in polietilene
spessore mm. 3,5
profondità cm.120x120
Pair of knotted nets
4x2 m. polietilene
thickness 3,5 mm.
cm.120x120 depth

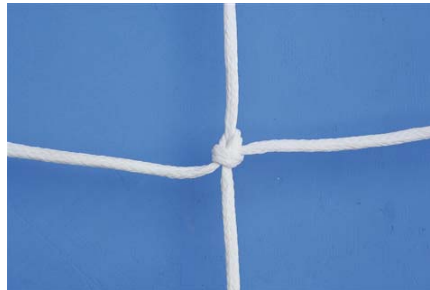

Art. 133NP
Coppia Reti m. 4x2
annodate in polietilene
spessore mm. 3,5
profondità cm.100x160
Pair of knotted nets
4x2 m. polietilene
thickness 3,5 mm.
cm.100x160 depth

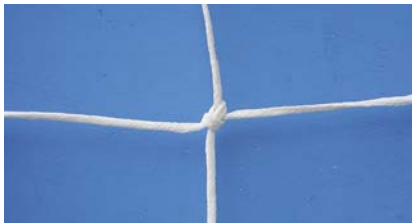
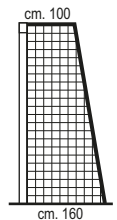

Art. 132N
Coppia Reti m. 5x2
annodate in polietilene mm. 2,5
profondità cm.120x120
Pair of knotted nets
5x2 m. polietilene
thickness 2,5 mm.
cm.120x120 depth

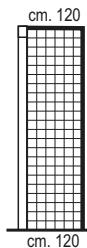

pg.27

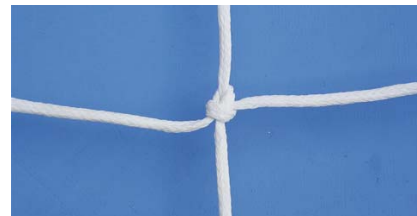

Art. B171
Coppia Reti m. 5x2
annodate in polietilene mm. 3,5
profondità cm.100x160
Pair of knotted nets
5x2 m. polietilene
thickness 3,5 mm.
cm.100x160 depth

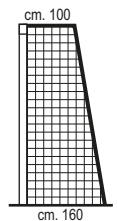

Art. 131N
Coppia Reti m. 6x2
annodate in polietilene mm. 2,5
profondità cm.120x120
Pair of knotted nets
6x2 m. polietilene
thickness 2,5 mm.
cm.120x120 depth

Art. B170
Coppia Reti m. 6x2
annodate in polietilene mm. 3,5
profondità cm.100x160
Pair of knotted nets
6x2 m. polietilene
thickness 3,5 mm.
cm.100x160 depth

Art. 131.22
Coppia Reti
m. 6x2,2
annodate in
polietilene
mm. 3,5
profondità
cm.100x160
Pair of knotted nets
6x2,20 m.
polietilene
thickness 3,5 mm.
cm.100x160 depth

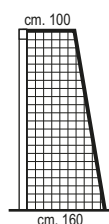
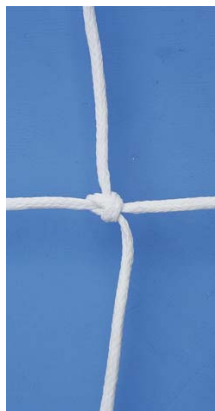

Art. 131.5
Coppia Reti
m. 6,50x2,50
in polipropilene
mm. 4
profondità
cm.120x120
Pair of nets
6,50x2,50 m.
Polipropilene
mm. 4 thickness
cm.120x120 depth

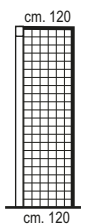
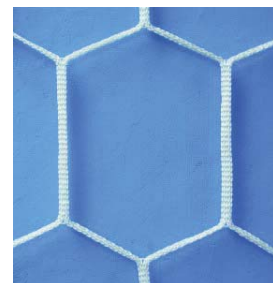

RETI CALCETTO - Futsal Nets m. 3x2

Profondità cm.100x100
Depth: 100x100 cm.

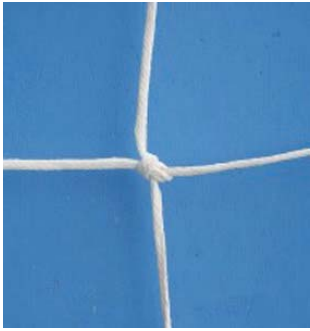

Art. 134E
Coppia reti m.3x2 annodate in polietilene spessore mm.2,5
Pair of 3x2 meter nets knotted polietilene thickness 2,5 mm.

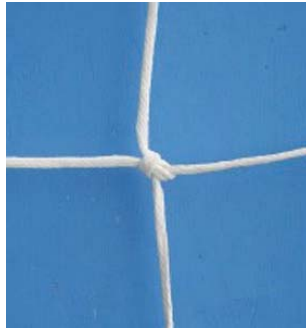

Art. 135C
Coppia reti m.3x2 annodate in polietilene spessore mm.3,5
Pair of 3x2 meter nets knotted polietilene thickness 3,5 mm.

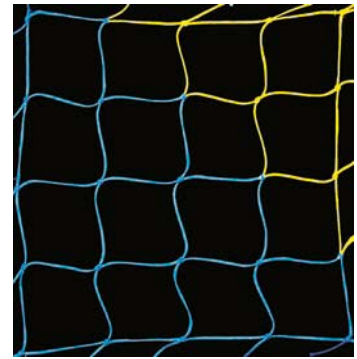
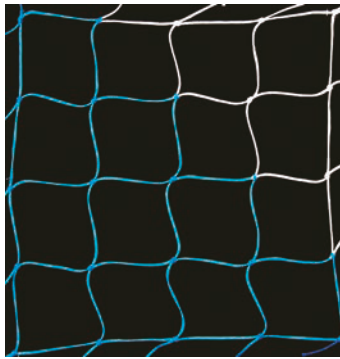
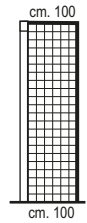

Art. 135FR Coppia reti m.3x2 annodate in polietilene spessore mm.3 colori: bianco-royal, bianco-rosso, giallo-royal
Pair of 3x2 meter nets knotted polietilene thickness 3 mm. colors: royal/white, red/white, yellow/royal

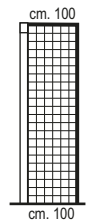
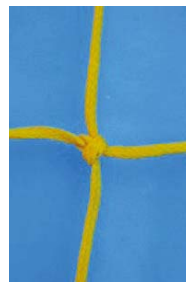
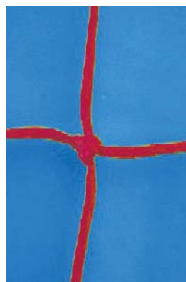

Art. 135 Coppia reti m.3x2 annodate in polietilene spessore mm.4,5 colori: rosso, bianco, giallo
Pair of 3x2 meter nets knotted polietilene thickness 4,5 mm. Colors: red, yellow or white

pg.27



Art. 137
Coppia reti **m.1,5x1,1** per Miniporte
Pair of nets 1,5x1,1 m. for Mini-goals

RETI PORTAPALLONI - Ball sacs



Art. 041-6 / 041-12 / 041-18
Reti Portapalloni in polipropilene senza nodo (da 6, 12 o 18 palloni)
Nets for balls in polypropylene (for 6, 12 or 18 balls)



S041-6 / S041-12 / S041-18
Reti Portapalloni in polipropilene con nodo (da 6, 12 o 18 palloni)
Knotted Nets for balls in polypropylene (for 6, 12 or 18 balls)

pg.28

Art. SM20
Sacca Portapalloni in nylon 420/PVC
capienza 20 palloni
Ball Sac for 20 balls



RETI DI PROTEZIONE - Protection nets



TUTTE LE RETI DI PROTEZIONE VENGONO REALIZZATE SU MISURA IN BASE ALLE RICHIESTE DEL CLIENTE IN CIRCA 10 GIORNI

All protection nets are manufactured according to Customer's needs in about 10 days

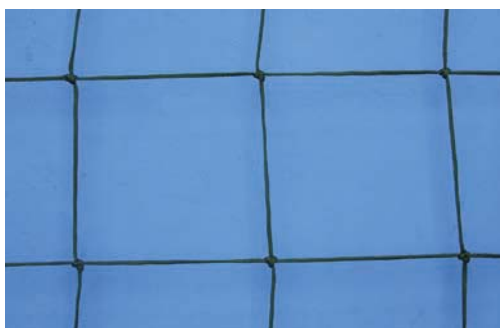

● pg.28



Art. 093N
Rete protezione polietilene verde annodata
maglia cm. 13x13 sp. mm.2,5
(per calcio e calcetto)
Protection Net green polyethylene mesh
13x13 cm. knotted, thickness 2,5 mm.

Art. 093.5
Rete protezione polietilene verde
annodata maglia cm. 13x13 sp. mm.3,5
(per calcio e calcetto)
Protection Net green polyethylene mesh
13x13 cm. knotted, thickness 3,5 mm.



Art. 0934N
Rete protezione
polietilene verde annodata
maglia mm. 45x45 sp. mm.2
(per tennis e baseball)
Protection Net green
polyethylene mesh
4,5x4,5 cm. knotted, thick 2 mm.
(for tennis and baseball)

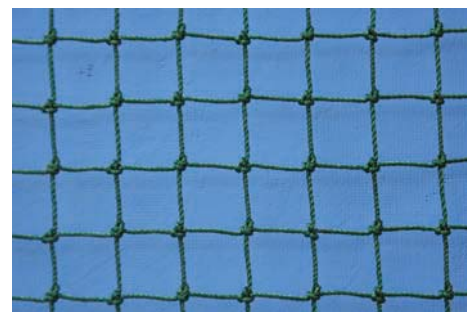

Art. R55
Rete protezione polietilene
nera maglia mm.18
annodata sp. mm.2
antioggetto / antipetardo
Protection Net
anti-objects and fire crackers

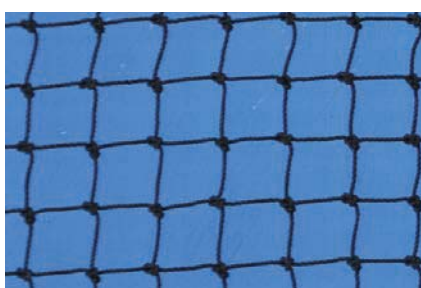

Art. R57
Rete protezione polietilene verde maglia
mm.25x25 sp. mm.3 (per golf)
Protection Net for golf

RETI PER CALCI DI PRECISIONE - Precision shooting nets

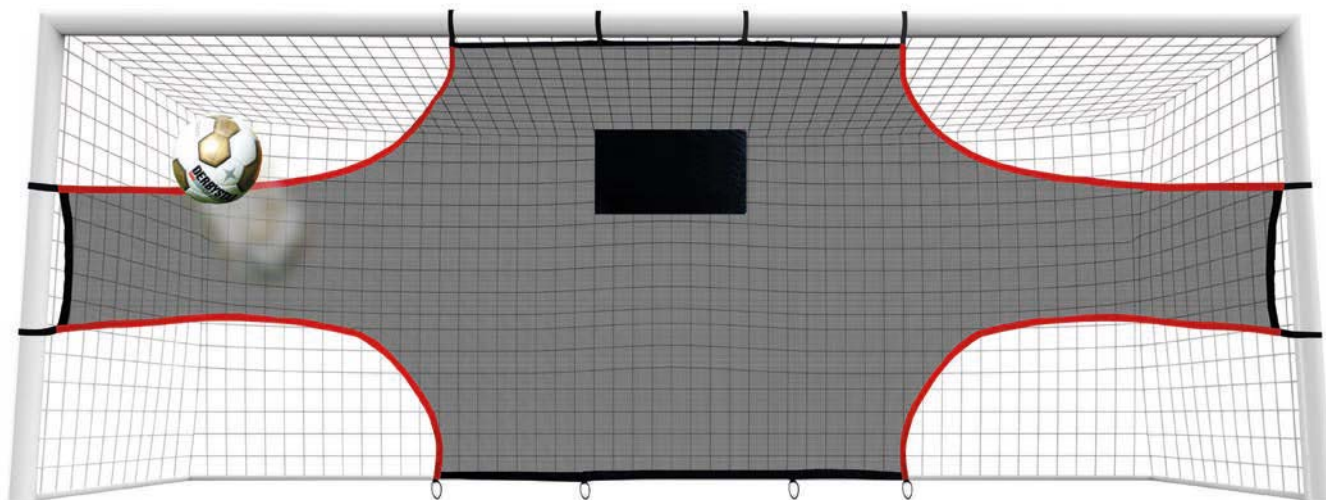

Art. PTI.732

Rete bersaglio per porta regolamentare completa di fasce con velcro per fissaggio a pali e traversa e picchetti per ancoraggio a terra

pg.28

Target net for regular size goal complete with velcro straps for fixing to poles and crossbar and pegs for ground anchoring

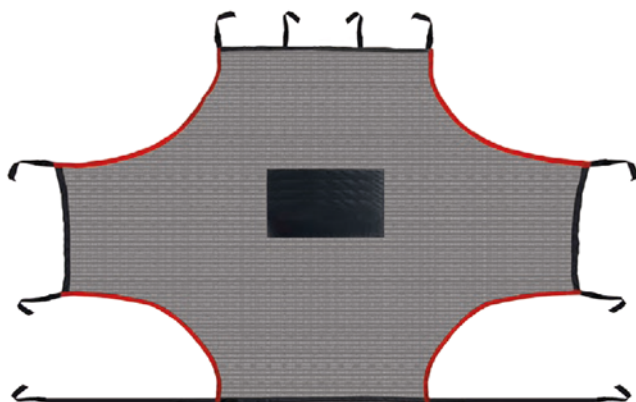

pg.28

Art. PTI.275

Rete bersaglio per porta m.3x2 completa di fasce con velcro per fissaggio a pali e traversa e picchetti per ancoraggio a terra

Target net for futsal goal complete with velcro straps for fixing to poles and crossbar and pegs for ground anchoring

pg.28

4 tasche bersaglio per calci di estrema precisione



4 target pockets for very accurate shootings

Basta raccogliere palloni in fondo al sacco, lascia che sia la palla a tornare da te!

Stop picking up balls all the time, let the ball come back to you!

Art. GM

Rete respingente con 4 tasche per calci di precisione completa di corda elastica e picchetti da applicare a porta regolamentare

Special net with 4 accuracy pockets including elastic rope and pegs for regular size goal

Art. GM42

Rete respingente con 4 tasche per calci di precisione completa di corda elastica e picchetti da applicare a porta m. 4x2

Special net with 4 accuracy pockets including elastic rope and pegs for m. 4x2 goal



pg.28

ART. 05020785

Set bande elastiche per allenamento ai tiri di precisione - completo di borsa impermeabile composto da 3 strisce orizzontali + 3 verticali + 2 strisce bianche per utilizzo su superfici sintetiche + 3 sacchi per sabbia (da riempire) + accessori per il fissaggio - da applicare a porta regolamentare

Straps for flexible marking of target zones for official size goal

Set of 3 horizontal bands + 3 vertical bands

+ 2 bands (white) for indoor use, on artificial turf etc. + 3 sandbags (without sand) + fixing accessories
Packed in a waterproof bag

New!

pg.7

Art. QBFG
CROSS TRAINING
rete bersaglio
sempre in piedi per
allenamento alla
precisione del cross,
del lancio in
profondità,
del rinvio del portiere
CROSS TRAINING
movable target to
improve crossing, long
passing and GK kicks
precision

Il bersaglio ha dimensioni cm.120x120,
ha una inclinazione regolabile da
orizzontale a quasi verticale ed è in grado
di ricevere la palla ad altezze comprese
tra cm.175 e cm.262
senza mai cadere a terra
base in alluminio, peso Kg.10
facilmente spostabile sul campo

The basket is adjustable from horizontal to
nearly vertical, height adjustable from 175
to 262 cm. - aluminium base, weight 10 Kg.
very easy to move on the field, never falls
down when hit by the ball



PANCHINE ALLENATORI - Trainers' dug-outs



Panchina allenatori
profilo curvato
mm. 50x30 in acciaio
zincato a caldo
Art. V6230 e seguenti
rivestimento
posteriore e laterale
in policarbonato
alveolare non
trasparente spessore
mm. 4,
piano di seduta con
scocche in
polipropilene montate
su telaio zincato

Altezza tettuccio cm. 200, profondità fianco laterale cm. 88

● pg.29

Panchina allenatori
profilo curvato
mm. 50x30 in acciaio
zincato a caldo
Art. V6220
e seguenti
rivestimento
posteriore e laterale in
policarbonato
trasparente spessore
mm. 3, piano di seduta
con scocche in
polipropilene montate
su telaio zincato



Art. V6285
Protezione in poliuretano espanso
per bordo panchina allenatori
con profilo mm. 50x30

Art. V6288
Coppia ruote da applicare a
panchina con profilo
mm. 50x30 al fine
di renderla trasportabile





Art. 155AV/156AV/157AV/158AV/159AV/159.7AV/159.8AV/155AV4

Panchina allenatori con struttura in tubo quadro in lega d'alluminio mm. 30x30 con copertura in policarbonato alveolare non trasparente - fianchi laterali in policarbonato trasparente (2 scocche di seduta in polipropilene per ogni metro di lunghezza)
Dug-out in light alloy square pipe mm. 30x30 with non transparent alveolar protection
Transparent protection on both sides (2 polypropylene seats per every meter of length)

● pg.30

È possibile sostituire le scocche con le panche a listoni in legno con schienale senza variazioni di prezzo
Available wooden benches with back in spite of seats, at the same price



È necessario fissare le panchine su una base in cemento tramite tasselli: la base dovrà essere più estesa di circa 30 cm. per ciascun lato rispetto alla lunghezza e alla profondità della panchina.
It is necessary to anchor dug-outs upon concrete base. Size of concrete base must be about 60 cm. longer and deeper than dug-out perimeter size (30 cm. longer and wider on each of the 4 sides)



Altezza tettuccio cm. 200 profondità fianco laterale cm. 74
Roof height 200 cm. - side depth 74 cm.



Art. 155/156/157/158/159/159.7/159.8/155-4

Panchina con struttura in tubo quadro in lega d'alluminio mm. 30x30 con copertura in policarbonato trasparente e scocche di seduta in polipropilene (2 scocche di seduta per ogni metro di lunghezza)

Dug-out in light alloy square pipe mm. 30x30 with transparent polycarbonate protection (2 polypropylene seats per every meter of length) pg.29 pg.30

La verniciatura con colore a richiesta del tubo quadro in alluminio comporta una maggiorazione del prezzo del 10%
Optional painting of the square pipe frame in aluminium (color on request): 10% additional charge on selling price

È possibile sostituire le scocche con le panche a listoni in legno con schienale senza variazioni di prezzo
Available wooden benches with back in spite of seats, at the same price

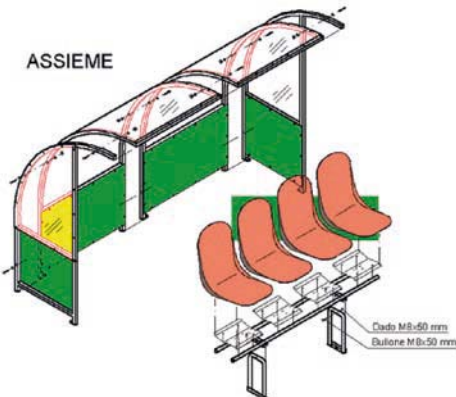

Art. ASBI
Seduta ricambio per panchina allenatori colore rosso o blu, fissaggio con 4 viti
Spare Seat for Dug-Outs in red or blue color, fixing with 4 screws

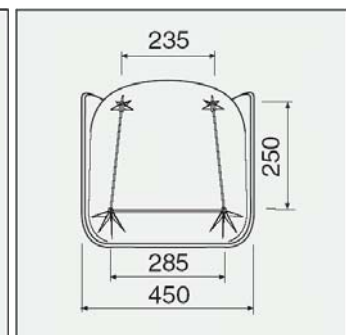
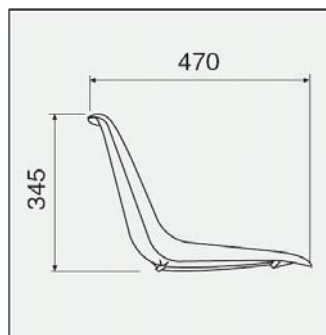

È necessario fissare le panchine su una base in cemento tramite tasselli: la base dovrà essere più estesa di circa 30 cm. per ciascun lato rispetto alla lunghezza e alla profondità della panchina
It is necessary to anchor dug-outs upon concrete base. Size of concrete base must be about 60 cm. longer and deeper than dug-out perimeter size (30 cm. longer and wider on each of the 4 sides)

PANCHINE ALLENATORI IDEALI PER CAMPI CALCETTO Trainers' dug-outs for futsal pitches



Panchina allenatori profilo curvato
mm 40x20 in lega di alluminio
rivestimento posteriore e laterale
in policarbonato alveolare sp. mm. 4
profondità a terra cm. 97,
altezza massima cm. 208
lunghezza metri 2 oppure metri 3
con panca sedute
in acciaio zincato e legno
Art. V6242.2 e Art. V6242.3
o con panca sedute
in alluminio anodizzato
Art. V6241.2 e Art. V6241.3

● pg.31



Dug-out curved profile
40x20 mm. in light alloy
rear and side coverings
in non transparent polycarbonate
4 mm. thick
soil depth 97 cm.
maximum height 208 cm.
2 meters or 3 meters length
with wooden bench on
galvanized steel
Art V6242.2 and V6242.3
or with bench in
anodized aluminium
Art V6241.2 and V6241.3

PANCHINE ALLENATORI IDEALI PER CAMPI CALCETTO Trainers' dug-outs for futsal pitches



Panchina allenatori trasportabile su ruote, profilo curvato mm. 50x30 in lega di alluminio rivestimento posteriore e laterale in policarbonato alveolare sp. mm. 4 **Art. V6291** oppure in policarbonato trasparente sp. mm. 3 **Art. V6292** profondità a terra cm. 150, altezza utile cm. 210 lunghezza metri 3 con supporto sedute in acciaio zincato e 6 scocche in polipropilene con piano borse sul retro dei seggiolini

pg.31

Dug-out transportable on wheels curved profile 50x30 mm. in light alloy rear and side coverings in non transparent polycarbonate mm. 4 thick **Art V6291** or in transparent polycarbonate mm. 3 thick **Art V6292** depth on the ground 150 cm. useful height 210 cm. length 3 meters with galvanized steel seat support and 6 polypropylene seats with back space for bags



Art. S04910
Panchina bordo campo struttura in acciaio zincato lunghezza cm. 200 con 4 scocche di seduta in polipropilene colorato
4 Sideline seats on galvanized steel frame length 200 cm.

pg.42



Art. 155FZ2/155FZ4/155FZ6/155FZ8

Panchina allenatori in acciaio zincato a caldo rinforzato profilo mm. 40x40 con profondità cm.180 (misurando da tettuccio a limite base posteriore di appoggio) rivestita con lastre in policarbonato trasparente spessore mm. 3 piano di seduta con scocche in polipropilene

Dug-Out in galvanized steel pipe 40x40 mm. - 180 cm. depth (from back protection to edge of roof)
transparent polycarbonate 3 mm. thick back cover - polypropylene seats on steel frame (2 seats each meter)



● pg.30

Art. 155PR

Rivestimento di protezione in schiumato per tettuccio e montanti
Soft edge protections



Art. LXR2/LXR4/LXR6/LXR8

Panchina allenatori in tubo di acciaio zincato a caldo profilo mm. 40x40 TRASPORTABILE su ruote - copertura in policarbonato trasparente profondità cm. 135 piano di seduta con scocche in polipropilene

Dug-Out in galvanized steel pipe 40x40 mm. - TRANSPORTABLE on wheels
transparent polycarbonate back cover, polypropylene seats

PANCHINE LUSO CON SEDUTE IN ECOPELLE - Leather seat dug-outs

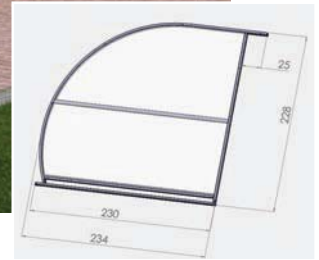

**PREVENTIVO SU RICHIESTA
PRICES ON REQUEST**

**Modelli fissi o trasportabili
struttura in acciaio zincato
poltrone in ecopelle personalizzabili**
Fixed or transportable Dug-Outs
galvanized steel frame
customizable leather seats

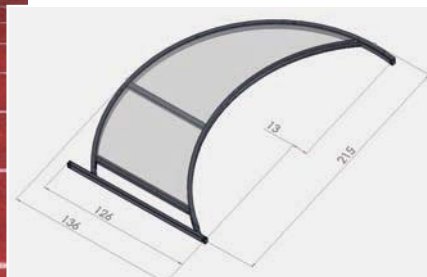

CARRELLI TRACCIALINEE - Line markers

pg.28



Per una resa ottimale e per evitare inconvenienti utilizzare sempre carbonato di calcio asciutto, ovvero la comune polvere di marmo

For optimal performance always use dry calcium carbonate, that is the common marble dust

Art. 142S
Carrello traccialinee a polvere
Marble Powder Line Marker

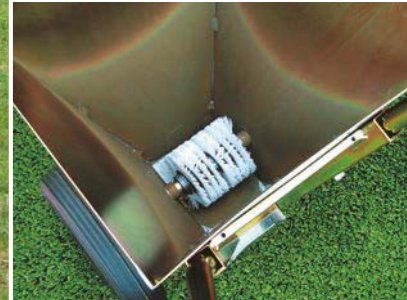

UTILIZZARE SOLTANTO VERNICE ECOLOGICA ATOSSICA E PULIRE DOPO OGNI USO IL SERBATOIO E TUTTO IL CIRCUITO DI SPRUZZO FINO AGLI UGELLI (occorre spruzzare ripetutamente acqua prima di riporre l'attrezzo)
Always use ecological paint and wash with water after use (put water in the tank and spray)



Art. 144
Carrello traccialinee a vernice ecologica con serbatoio munito di pompante a pressione manuale
Paint Line Marker with manual pressure tank

pg.28



Particolare
leva pressione
spruzzo

Art. 145
Carrello traccialinee a vernice ecologica con motore a scoppio a miscela serbatoio vernice lt.25 tracciatura laterale regolabile
Paint Line Marker with 2 stroke engine 25 liter tank



Art. 144.EL

Carrello traccialinee a vernice elettrico completo di caricabatteria (per la batteria della pompa elettrica) capacità serbatoio litri 18 tracciatura laterale regolabile
Electric Line Marker complete with battery charger 18 liter tank adjustable lateral marking device

● pg.28

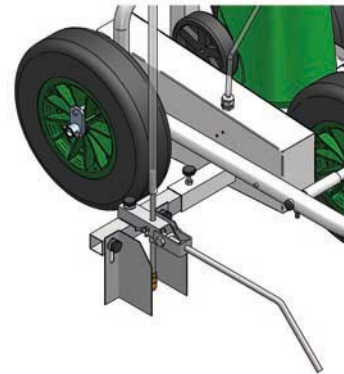

Art. F211

Mirino in acciaio zincato per carrelli traccialinee Art. 144.EL ed Art. 145
Foresight in galvanized steel for line markers Art. 144.EL and Art. 145

● pg.28

Art. 144.SL

Carrello traccialinee a rulli senza serbatoio a pressione né motore a scoppio. Tramite la rotazione dei rulli, la vernice viene prelevata all'interno del serbatoio e spalmata sull'erba.

Roller Paint Line Marker
Just fill up the tank with paint and push the machine.

Taking advantage of rolling wheels, paint flows from tank down to grass the easiest way!





Art. 146

Vernice Ecologica atossica per manti erbosi Linea Stadio
lt. 15 - Kg. 19 ad alto rendimento
Ecological Paint for grass 15 liters - 19 Kg.

pg.28



Art. 146E

Vernice Ecologica atossica per manti erbosi Biancostadio lt. 17 - Kg. 19
Ecological Paint for grass 17 liters - 19 Kg.

pg.29



Art. NTESA

Rotolo Nastro adesivo mt. 50 - larghezza cm. 5 vari colori per tracciatura righe su superfici sintetiche
Tape for bounds 50 meter - 5 cm. width

Art. 146BP/146BPG

Vernice bianca o gialla per manti sintetici a bassa permanenza (1 settimana) 17 litri
Paint for artificial grass white or yellow color, short durability (1 week) 17 liters



Art. 146LP/146LPG

Vernice bianca o gialla per manti sintetici a lunga permanenza (3 mesi) 17 litri, da utilizzare solo con carrello a rulli
Paint for artificial grass white or yellow color, long durability (3 months) 17 liters



Art. SIFS

Fettuccia segnasettore impermeabile colore bianco o rosso larghezza mm. 50 in rotoli da mt. 25 (chiodi inclusi)
Sector line in waterproof synthetic fabric, width 50 mm. length 25 m. color white or red (pegs included)



Art. ELP2/ELP4

Elasticone per divisione spazi larghezza cm. 2 oppure cm. 4 lunghezza mt. 20, completo di 2 moschettoni
Elastic bound 2 cm. width or 4 cm. width - length 20 meters - with 2 hooks



Art. NS200

Rotolo nastro stradale mt. 200 - bianco/rosso
Red/White Tape length 200 meters



Art. PFIx Plifix

Picchetto di riferimento permanente con erba sintetica bianca o colorata, per agevolare la tracciatura delle righe dei campi di gioco o per delimitazione aree
Confezione da 25 pezzi incluso Plifix - permanent peg with artificial white or coloured grass to help tracing lines on the field or mark areas 25 pieces set includes also plastic planting device



SEDUTE PER GRADINATE - Stadium seats

COLORI DISPONIBILI: blu, rosso, giallo, verde, bianco, nero, grigio
AVAILABLE COLORS: blue, red, yellow, green, white, black, grey

ORDINE MINIMO 10 PEZZI PER MODELLO E COLORE
 Minimum quantity 10 pieces per model and color

**ATTENZIONE:
 NON PER PANCHINE
 ALLENATORI!
 NOT FOR TRAINERS'
 DUG-OUTS!**



Art. M2003/M2003A

Art. M2003 Seduta in polipropilene con schienale ignifuga e antiultravioletti (secondo normativa UEFA) fissaggio diretto sulla gradinata con tasselli (non inclusi)
 Polypropylene Seat non ignitable and anti-ultraviolet rays with back rest (according to UEFA requirements) to be fixed with screws (not included)

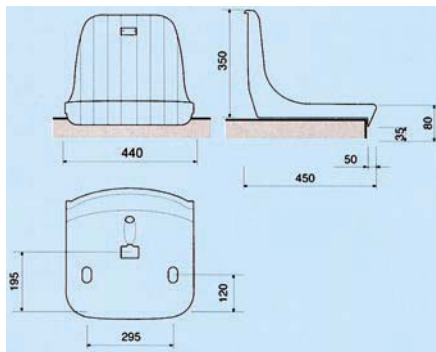

Art. M2003A Seduta in polipropilene con schienale come Art. M2003 solo antiultravioletti, fissaggio diretto sulla gradinata con tasselli (non inclusi)
 Polypropylene Seat as Art. M2003 anti-ultraviolet rays, with back rest to be fixed with screws (not included)

pg.31

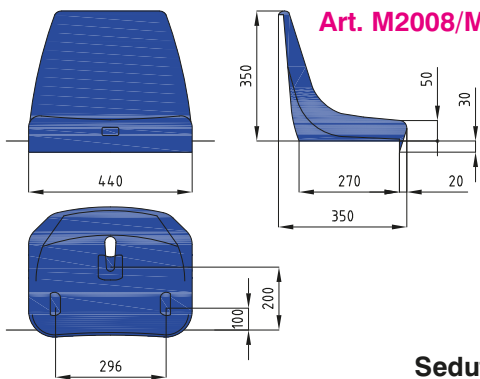

Art. M2008/M2008A



Seduta in polipropilene con schienale ignifuga e antiultravioletti Art. M2008 oppure solo antiultravioletti Art. M2008A - fissaggio diretto sulla gradinata con tasselli (non inclusi)
 Polypropylene Seat non ignitable and anti-ultraviolet rays **Art. M2008** or only anti-ultraviolet rays **Art. M2008A** with back rest to be fixed with screws (not included)

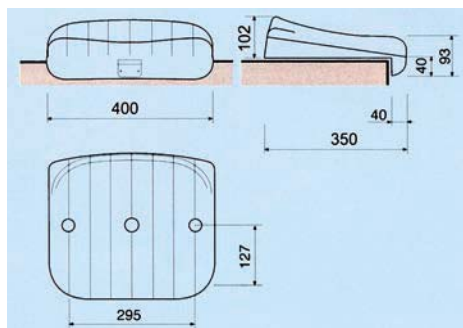
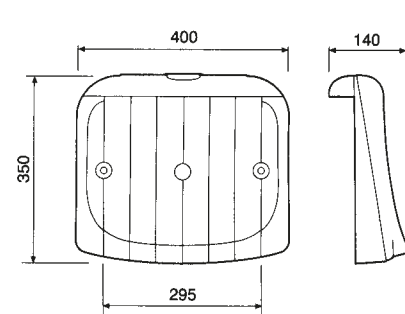

Art. M90/M90.A

Art. M90 Seduta in polipropilene senza schienale ignifuga e antiultravioletti fissaggio diretto sulla gradinata con tasselli (non inclusi)

Polypropylene Seat non ignitable and anti-ultraviolet rays, without back rest - to be fixed with screws (not included)

Art. M90.A Seduta in polipropilene senza schienale come Art. M90 solo antiultravioletti fissaggio diretto sulla gradinata con tasselli (non inclusi)

Polypropylene Seat as Art. M90 anti-ultraviolet rays, without back rest - to be fixed with screws (not included)

pg.31

TRIBUNE - Stands



Art. G12005

Modulo Tribuna per interno/esterno su 3 file in acciaio zincato trasportabile su ruote, piani di seduta in carply, lunghezza m. 2,5
Indoor/outdoor Stand in galvanized steel, 3 rows, movable on wheels, with wooden benches



pg.32



Art. G12006

Modulo Tribuna per interno/esterno su 3 file in acciaio zincato trasportabile su ruote, piani di seduta con scocche in polipropilene, lunghezza m. 2,5
Indoor/outdoor Stand in galvanized steel, 3 rows, movable on wheels, with polypropylene seats



Art. G120TM
**Tribuna telescopica da interno
con sedute in polipropilene**
Telescopic Stand for indoor
with polypropylene seats

pg.32



pg.31

Art. CTMB1
**Cuscino per tribuna pieghevole
rivestito in nylon**
colori blu o rosso, bordo nero
(ordine minimo 30 pezzi per colore)
Foldable seat Cover - color blue or red
(minimum quantity 30 pieces per color)



Art. S07700
**Transenna in
acciaio zincato**
cm. 200x100h.
Galvanized steel barrier 200x100 cm.

pg.32



Art. S07710
**Transenna in plastica cm. 215x90h. con piedi di appoggio
a terra ruotabili, con banda catarifrangente e sistema di
aggancio a catena**
Plastic barrier 215x90 cm.

ARREDI PER SPOGLIATOIO - Dressing Room Benches



Art. S07326 / S07324
Tavola appendiabiti
con grucce m.1 / m.2
Clothes hanger board m.1 / m.2

Art. S07322 / S07320
Tavola appendiabiti con tettuccio lunghezza m.1 / m.2
Clothes hanger board with bag holder m.1 / m.2

Art. S902.1E / S902.2E
Panca in acciaio verniciato
con listoni in legno m.1 / m.2
con schienale e appendiabiti
Bench in painted steel and
wood length m.1 / m.2
with back rest and clothes hanger board



Art. S07308 / S07306
Panca in acciaio verniciato
con listoni in legno
m.1 / m.2 con schienale
Bench in painted steel and
wood length m.1 / m.2
with back rest

Art. S07304 / S07302
Panca in acciaio verniciato
con listoni in legno m.1 / m.2
Bench in painted steel and
wood length m.1 / m.2

pg.32



Art. S07406 / S07404
Pedana poggia piedi a listoni
in legno lunghezza m.1 / m.2
Footrest in wood, length m.1 / m.2

Art. S07312 / S07310
Panca con schienale, appendiabiti e
portaborse in acciaio verniciato
con listoni in legno
lunghezza m.1 / m.2
Complete Bench
in painted steel and
wood length m.1 / m.2

Disponibile
anche lunghezza
m. 1,5
(al prezzo della
lunghezza m. 2)
Also available
length 1,5 m.
(at the same price
as length 2 m.)



Art. S07314
Panca completa
ad isola per centro
locale m.2
in acciaio verniciato
con listoni in legno
Double bench
in painted steel and
wood length m.2

Colore standard del telaio: rosso
Per argento o giallo supplemento 5%
Standard color of frame: red
For silver or yellow 5% price increase



Panca con schienale, appendiabiti e portaborse in alluminio anodizzato con inserti in PVC lunghezza m. 1 Art. V8626 oppure lunghezza m. 2 Art. V8627
 Complete Bench in anodized aluminium length m. 1 Art. V8626 or length m. 2 Art. V8627

pg.32 pg.33

Pedana poggiapiedi in alluminio anodizzato lunghezza m. 1 Art. V9092 oppure lunghezza m. 2 Art. V9093
 Footrest in anodized aluminium length 1 or 2 meters

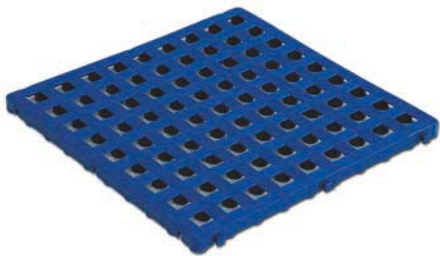

Art. S07408
Pedana poggiapiedi in plastica cm. 50x50
 Plastic footrest 50x50 cm.



Art. S07434
Graticcio per doccia in legno cm. 60x60
 Wooden footrest 60x60 cm.



Art. S07466
Asciugacapelli elettrico con temporizzatore e tubo flessibile
 Hair dryer with timer and flexible pipe



Art. TPD Poggiapiedi Footsy idrorepellente
 Foldable foot rest waterproof



Art. S07458
Asciugamani elettrico con temporizzatore
 Hand dryer with timer

ALTRI ARTICOLI SUL LISTINO PREZZI

pg.33



Art. S07462
Asciugacapelli elettrico con temporizzatore
 Hair dryer with timer

ARMADIETTI PER SPOGLIATOIO Dressing Room Lockers



Art. S07226
Armadio spogliatoio
a 15 posti in lamiera verniciata
dimensioni totali
overall dimensions
cm. 103Lx35px180h



● pg.34

Art. MAP30
Armadio portavalori a 30 sportelli
dim. cm. 50hx95Lx20p con serrature
Safe-deposit locker with 30 boxes

Art. MAP50
Armadio portavalori a 50 sportelli
dim. cm. 82hx95Lx20p con serrature
Safe-deposit locker with 50 boxes



Armadietti in laminato - HPL panels

Art. S07252 / S07254 / S07256
Armadio spogliatoio in laminato
dim. vano cm.30Lx50px90h
1 colonna 2 vani
2 colonne 4 vani
3 colonne 6 vani
Laminated Lockers

Art. S07258 / S07260 / S07262
Armadio spogliatoio in laminato
dim. vano cm.30Lx50px180h
1 colonna 1 vano
2 colonne 2 vani
3 colonne 3 vani
Laminated Lockers

ACCESSORI PER SPOGLIATOIO E INFERMERIA Dressing room and infirmary accessories



Art. S07448
Specchio a parete
con cornice in plastica
diam.cm.60
Wall mirror with frame
diameter 60 cm.

Art. S07438
Distributore di sapone
liquido a parete
Wall soap dispenser



Art. S07442
Distributore di salviette a parete
Wall towel dispenser



ALTRI ARTICOLI SUL
LISTINO PREZZI



Art. S07412
Tavolo per
spogliatoio e
locale arbitri
cm. 80x80x76
Locker room
table
80x80x76 cm.

pg.33



Art. S07416 Bacheca
con struttura in alluminio cm. 120x90
Bulletin Board 120x90 cm.

Art. S07414
Sedia in acciaio cromato
scocca in polipropilene
Chromed steel chair
with polypropylene seat



Art. S07418
Portaombrelli a 24 posti
in acciaio verniciato
Steel umbrella stand



Art. S07715 Spazzolone
per pulizia e asciugatura
area pubblica e campo di gioco
Scrubber for cleaning playcourt



Art. S07102 / S07104
Armadio a vetri a una o due ante
 Glass Cabinet with one or two doors



Art. S07106 **Paravento a tre ante**
struttura in acciaio cromato
 Three shutter foldable screen



Art. S07138
Cassetta medica secondo D.M. 388
 First aid kit

pg.33

pg.34

ALTRI ARTICOLI SUL
 LISTINO PREZZI



Art. S07128
Scaletta scendiletto
in acciaio cromato
 Bedside step



Art. S07124
Sgabello girevole
in alluminio
 Turnable stool



Art. S07108
Appendiabiti a colonna
in acciaio cromato
 Clothes stand



Art. S07132
Cestino in plastica
 Plastic trashcan

Art. S07130
Portarifiuti
a pedale
in acciaio
verniciato
 Metal trashcan



Art. S07134
Barella pieghevole
in acciaio cromato
 Foldable Stretcher in
 chromed steel



Art. S07110
Scrivania con cassettera
 dim. cm.130x76x78
 Desk with 3 drawers dimensions 130x76x78 cm.



Art. S07114
Sedia imbottita, in acciaio cromato Chair in chromed steel



Art. S07410
Tavolo per massaggi in acciaio imbottito in similpelle
 Massage table

Art. PBN
Bilancia pesapersona con statimetro
 Scales with height measurer



pg.33 pg.34

Art. PTI.BIL
Bilancia pesapersona digitale con indicazione massa grassa
 Digital scales body fat measurer



Art. 3031S
Lettino Antero chiudibile testiera regolabile
 cm.180x60x73
 peso Kg.20
 colore nero
 in acciaio cromato
 Medical couch foldable in chromed steel

Art. 3033S
Borsone porta lettino Antero
 Bag for Art. 3031S

Art. S07118
Portarotolo
 Paper roll holder

Art. S07120
Rotolo carta
 Roll of paper



Art. S07116
Lettino visita medica imbottito con testiera reclinabile
 Medical couch in chromed steel, padded, adjustable headrest

TUNNEL USCITA SPOGLIATOI - Stadium tunnels



Art. 160 Tunnel estensibile struttura in lega d'alluminio, copertura in PVC ignifugo Cl.2 bianco o colorato, montato su ruote in nylon, dimensioni standard (personalizzabili): larghezza cm.200, altezza al centro cm.232, altezza ai lati cm.200, in moduli da un metro
Extensible Tunnel in light alloy covered by fireproof PVC Cl.2, white or coloured, movable on nylon wheels - Standard dimensions 200 cm. width, 232 cm. height in the middle, 200 cm. height at the sides - made of one meter segments joined together



**Lunghezza, larghezza
e altezza
personalizzabili su richiesta**
Any dimension available
on request

BEACH SOCCER



Art. PBST Coppia Porte Beach Soccer m. 5,5x2,2
in lega d'alluminio, tubo sezione mm. 80
verniciate in giallo con bussole
Pair of Beach Soccer goals in aluminium
5,5x2,2 m. - pipe 80 mm.
painted yellow with sockets

pg.26

Art. 110BS
Coppia Porte Beach Soccer m. 5,5x2,2
in lega d'alluminio
tubo sezione mm. 120x100
verniciate in giallo con bussole
(senza innesti da cementare)
Pair of Beach Soccer goals in aluminium
5,5x2,2 m. - pipe 120x100 mm.
painted yellow with sockets



Art. 073BS
Kit 10 paletti
completi
per Beach Soccer
(6 bandierine rosse
e 4 bandierine gialle)
Beach Soccer
Kit of 10 Poles
(6 red flags and 4 yellow flags)

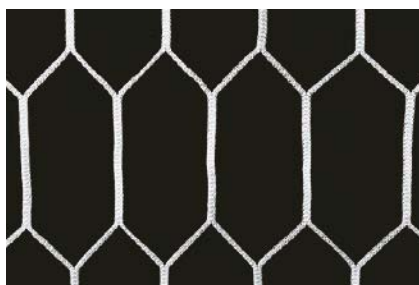

Art. RBS Coppia reti
per porte Beach Soccer
m. 5,5x2,2
in polipropilene
Pair of polypropylene
nets for
Beach Soccer goals
5,5x2,2 m.



Art. KDBS
Kit Delimitazione per campo Beach Soccer, colore
blu: 2 nastri m. 28 + 2 nastri m. 37 larghezza mm. 80
+ 8 picchetti e 8 elastici
Kit for Beach Soccer bounds



Art. ULT45
Pallone Beach
Soccer Trial in gomma
doppio strato
(fino ad esaurimento scorte)
Trial Beach Soccer Ball
double stratum rubber
(until available in stock)

TAVOLI CALCETTO - Soccer tables



Art. GA-F1
Tavolo calcetto
in legno modello F1
dim.cm.121x92x78h
aste telescopiche
ideale per bambini
Soccer table model F1
very good for children



Art. JKBOM
Tavolo calcetto Bomber
senza gettoniera
aste telescopiche,
piano in vetro temperato
colore blu o bianco
Soccer table Bomber

pg.44



Art. IS432
Confezione 10 palline per
tavolo calcetto
10 Soccer table balls



Art. FTGO.G
Tavolo calcetto modello Pride con
gettoniera, aste cromate telescopiche,
gambe in ferro verniciato, mobile in
multistrato, peso kg. 73
Soccer table model Pride with coin slot
telescopic, legs in painted steel, weight 73 Kg.



Da esterno
Art. G500
Tavolo calcetto da esterno
G500 Weatherproof
con aste telescopiche
Soccer table G500 for outdoor



Art. FTEC
Tavolo calcetto modello Pride
con vetro protettivo
ad alta resistenza, peso kg. 85
Model Pride with high resistance safety
glass, weight 85 Kg.

BASKET



pg.34





Art. S04056 / S04058

Impianto basket a muro fisso con sbalzo cm. 185 oppure cm. 325, tabelloni in bilaminato, canestri e retine
Wall basketball system projection 185 or 325 cm. wooden boards, rings and nets



Art. S04151

Impianto minibasket a muro fisso, sbalzo cm. 80, tabelloni in bilaminato canestri e retine
Wall mini-basketball system projection 80 cm.



pg.34

Art. S04152

Impianto minibasket a muro fisso, sbalzo cm. 185 tabelloni in bilaminato canestri e retine
Wall mini-basketball system projection 185 cm.



Art. S04150

Impianto basket/minibasket a muro regolabile in altezza con canestro e retina
Wall basketball/mini-basketball system adjustable height



Art. 0986

Impianto minibasket fisso a colonna zincato altezza regolabile tabelloni in resina canestri e retine altezza standard cm. 260 (su richiesta cm. 305)
Mini-basketball system galvanized steel posts, adjustable height, plastic boards, rings and nets standard height 260 cm. (305 cm. on request)

pg.35

Art. S04161

Coppia strutture minibasket agganciabili a tabelloni basket complete di tabelloni in bilaminato, canestri e retine (attrezzo per sollevamento tabelloni Art. S04162 non incluso)
Pair of mini-basketball constructions to be attached to basketball boards (rising tool Art. S04162 not included)



Art. S04162



Art. 0987
Impianto minibasket a colonna regolabile in altezza e trasportabile, fornito con canestri e retine
 Transportable mini-basket system

Altezza massima cm. 260
 Maximum height 260 cm.

pg.35



Art. S04012
Struttura basket e minibasket richiudibile e trasportabile in acciaio verniciato, base porta zavorra, tabellone in resina, canestro fisso e retina, protezione frontale
 Transportable and foldable Basket/Minibasket in painted steel, resin board, front protection



Art. 26760
Tabellone minibasket in plastica da fissare al muro, fornito con canestro e retina
 Wall minibasket board



pg.34

Art. 26759
Basket a colonna regolabile in altezza da cm. 229 a cm. 305 trasportabile, con canestro e retina tabellone cm.120x70 rinforzato

Basket adjustable height from 229 cm. to 305 cm. transportable



Art. PPV01
Protezione monotubolare singola in nylon idrorepellente con velcro cm. 180x9x2 per Art. 647B e Art. 26759
 Single monotubular soft protection for Art. 647B and Art. 26759



Art. F126BSK
Set Baskin trasportabile professional
 Transportable Baskin

Art. 647B Minibasket a colonna regolabile in altezza da cm. 168 a cm. 229 trasportabile, con canestro e retina tabellone cm. 90x60
 Minibasket adjustable height from 168 cm. to 229 cm. transportable



Art. F102
Canestro Basket regolamentare
 (retina esclusa)
 Basket standard



Art. F103
Canestro Basket rinforzato
 (retina esclusa)
 Basket reinforced



Art. F105
Canestro Basket zincato
 (retina esclusa)
 Basket galvanized



Art. B030
Coppia Retine in nylon
 mm. 3,5
 Pair of nets 3,5 mm.



Art. B050
Coppia Retine in nylon
 mm. 6
 Pair of nets 6 mm.



Art. B060
Coppia Retine in cotone mm. 7
 Pair of nets 7 mm.



Art. R122
Coppia Retine in acciaio
 Pair of steel nets



Art. F106
Canestro Basket reclinabile, a norme FIBA
 (retina esclusa)
 Reclining Basket



Art. S04236
Canestro Basket reclinabile, omologato a norme FIBA (retina esclusa)
 Approved reclining Basket

pg.35

Art. NRGC
Set 12 ganci reggirete in plastica per canestro basket
 Set 12 plastic basket net holders

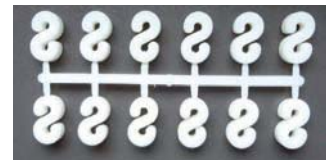

Art. S04202 - S04214 - S04204 - F116/B - S04216
Coppia tabelloni in bilaminato per interno oppure in resina melaminica per esterno - varie dimensioni
 Pair of basketball boards in chipboard for indoor or in resin for outdoor - various sizes

Brevettato
Patented



Art. F109
Canestro Basket reclinabile frontalmente e lateralmente (retina esclusa)
 Front/Side reclining Basket

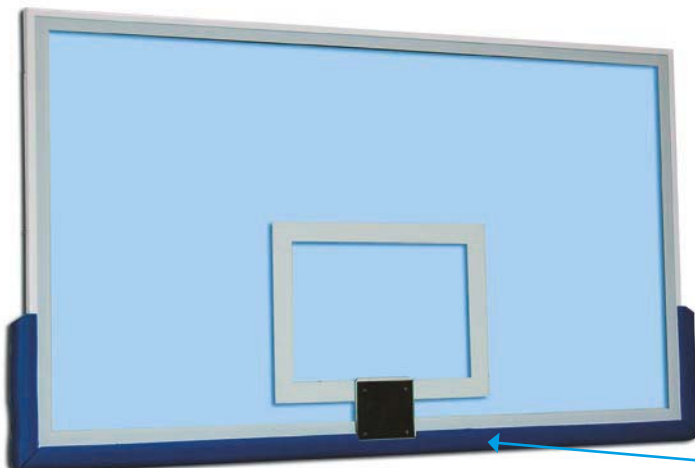

Art. S04206 / S04208
Coppia tabelloni in Plexiglass trasparente oppure cristallo temperato dimensioni cm. 180 x 105 - compreso telaio e protezione
 Pair of basketball boards in transparent acrylic or tempered glass 180 x 105 cm. mounted onto varnished steel frame with pads

Art. B2063B / B2063
Coppia Protezioni sottocanestro omologate FIBA e non
 Pair of soft board protection pads FIBA approved or not

pg.34

pg.35



Art. S04254
Panca per atleti e riserve con schienale m.3
 Bench length 3 meter with back rest

Art. S04266
Protezione mobile per tavolo giuria e atleti in policarbonato trasparente
 Transparent movable polycarbonate protection for benches and referees' table

pg.35



Art. ESB100 pg.45
Elemento di separazione e protezione bordo campo
 dim. cm. 120x40x100h.
 in gommapiuma D30 rivestita in PVC con fondo antiscivolo e velcro
 Foam rubber bound with PVC cover for floor delimitation size 120x40x100h. cm.



Art. S04256
Tavolo giuria
 cm. 160x80x76h.
 Referee table



Art. S04262
Tavolo giuria cm. 300x70x76h. carenato su ruote
 Referee table on wheels



Art. S04288
Freccia indicatrice possesso palla
 Ball possession arrow



Art. F255
Freccia indicatrice elettronica possesso palla
 Electronic ball possession indicator



Art. F254
Segnalatore time out con impugnatura
 Time out indicator



Art. CR016
Cronometro contasecondi da tavolo a pila con display digitale
 Digital Table Clock for basketball



Art. CR005
Cronometro contasecondi da tavolo a pila con lancette
 Table Clock for basketball



Art. S04280
Segnapunti
manuale
girevole
a 6 cifre
6 figure
Scoreboard

pg.35



Art. B01084
Segnapunti da tavolo per Basket
Table scoreboard



Art. S04274
Serie Palette 24"
Set of 24 sec indicators



Art. S04272
Serie palette per giudici
Set of referee's foul indicators



Art. S04282
Segnapunti manuale a parete a 6 cifre,
struttura in acciaio verniciato
Wall steel 6 figure scoreboard

pg.35

Art. 089-B
Lavagna Basket
cancellabile cm. 40x23
Basket Tactical Board
erasable 40x23 cm.



Art. 087-B
Lavagna
Basket
magnetica
cancellabile
cm. 60x85
Basket Tactical
Board erasable
and magnetic
60x85 cm.

pg.36



Art. LSRK
Lavagna Basket magnetica cm. 40x23
con block-notes (fino ad esaurimento)
Basket Tactical Board
magnetic 40x23 cm. with block-notes
(until available)

SKLZ >>



Art. SK.CVS

COURT VISION

Occhiali a visibilità limitata per allenamento al palleggio a testa alta, alla visione di gioco e alla reattività nei confronti dei difensori misura unica regolabile

Court vision dribble goggles force players to handle the ball with their head up to survey the court improve reaction time against defenders increase confidence on the court

SKLZ >>



Art. SK.KOT

KICK-OUT per ritorno palla dopo tiro a canestro - direzione regolabile

360° ball return system rotating chute returns made shots anywhere on the court easy twist adjustment with integrated handle



La fascia con le braccia gonfiate deve essere posizionata all'altezza delle spalle, e per installarla può essere necessario sgonfiare moderatamente la sagoma. Successivamente, dopo avere rigonfiato, se la sagoma torna in posizione verticale con difficoltà si deve aggiungere dell'acqua nel serbatoio

Art. KBVS

Kit braccia verticali per sagoma gonfiabile cm. 205 Art. SAG205

Raised arms kit for inflatable dummy 205 cm. Art. SAG205

Specifico per il Basket, il kit si installa facilmente sulla sagoma (non inclusa) e rende possibile una moltitudine di esercizi tecnico-tattici
Designed for Basket training, this kit is easily installed on the dummy (not included) and makes lots of technical and tactical exercises possible

SKLZ >>

pg.36



Art. SK.DMAN

Sagoma Basket D-MAN

ad altezza regolabile da cm. 198 a cm. 243 con basamento riempibile,

munita di puntali per fissaggio anche su terreni naturali

Hands-up defensive mannequin ideal for solo practice or team settings portable, lightweight adjustable telescoping pole (from 198 cm. to 243 cm.) Weighted base - including spikes for natural grass anchoring



Art. MSBK4 Pallone avviamento al Minibasket Mondo gomma nylon misura 4
Minibasket introduction ball



Art. SB4Y Pallone avviamento al Minibasket Molten gomma nylon misura 4
Minibasket introduction ball



Art. M13565 Pallone Street Basket Mondo 3x3 misura 6 (ad esaurimento)
Mondo Street Basket ball 3 vs 3 - size 6



Art. B3002 Pallone Basket e Minibasket gomma nylon misure 5-7
Nylon rubber Basket and Minibasket ball



Art. SBPRO5 Pallone Minibasket Mondo SB-PRO n. 5 gomma multistrato
Multilayer rubber Minibasket Mondo SB-PRO 5 ball



Art. B5G1600 Pallone Minibasket Molten B5G1600 gomma nylon (ex BGR5)
Nylon rubber Minibasket Molten B5G1600 ball

pg.36



Art. B7G1600/B6G1600 Pallone Basket Molten B7G1600/B6G1600 gomma nylon (ex BGR7/BGR6)
Nylon rubber Basket Molten B7G1600/B6G1600 ball



Art. B7G3800/B6G3800 Pallone Basket Molten B7G3800/B6G3800 pelle sintetica FIBA Approved (ex BGM7X/BGM6X)
Leather Basket Molten B7G3800/B6G3800 ball

Art. B7G4000/BGF6X Pallone Basket Molten B7G4000/BGF6X pelle sintetica ufficiale FIP
Leather Basket Molten B7G4000/BGF6X ball



Art. B7G4500/B6G4500 Pallone Basket Molten B7G4500/B6G4500 pelle sintetica ufficiale FIP Lega Serie A (ex BGG7X/BGG6X)
Leather Basket Molten B7G4500/B6G4500 ball



Art. TRBB Pallone reaction ball Trial rimbalzo e traiettorie imprevedibili per Basket
Trial Reaction Ball unpredictable rebounds



Art. BYCB Pallone Basket bicolore gomma Trial Ø cm. 24 gr. 620
Trial bicoloured rubber Basket ball



Art. ULTS67 Pallone Basket gomma Trial allenamento potenziato Ø cm. 24 gr. 930 (+50%)
Rubber Trial Heavier Basket ball



Art. ULTD67 Pallone Basket gomma Trial allenamento potenziato Ø cm. 24 gr. 1240 (+100%)
Rubber Trial Heavier Basket ball

PALLAVOLO - Volleyball



Art. 6746T

Art. 6746T
 Impianto pallavolo monotubolare in acciaio zincato Ø 76 mm. completo di bussole da interrare cm. 40 e tendirete, altezza della rete regolabile
 Volleyball posts in galvanized steel with underground sockets adjustable height net

pg.37

pg.38



Art. V5009

Art. V5009
 Impianto pallavolo monotubolare in alluminio T6 antiflessione mm. 120x100 con arganello tendirete autofrenante e senza cremagliera con manovella asportabile bussole e tappi in alluminio
 Aluminium monotubular volleyball posts



Art. ARGC
 Arganello a cremagliera con manovella per impianto pallavolo monotubolare
 Spare rack winch for monotubular volleyball posts

Lato interno
 Inner side



Art. V5003
 Impianto pallavolo monotubolare in acciaio zincato Ø 70 mm. completo di bussole da interrare e tendirete, con sistema telescopico per la regolazione della rete con doppia carrucola sulla sommità del palo
 Volleyball posts in galvanized steel with underground sockets telescopic posts adjustable height net

Art. 6747/P
 Impianto pallavolo monotubolare a norme FIPAV in alluminio sezione mm. 120x100 regolazione dell'altezza dei pali e della rete con sistema periscopico con arganello tendirete e bussole incluse
 Aluminium monotubular volleyball posts periscopic system FIPAV approved

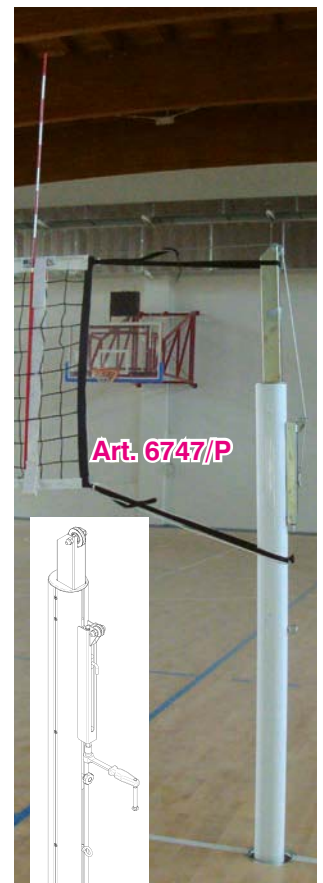

Art. 6747/P

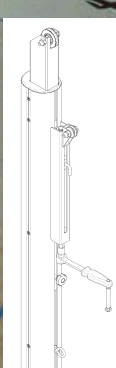

La regolazione periscopica permette di variare l'altezza dei pali insieme a quella della rete (che può essere regolata da cm. 215 a cm. 243)

Art. MB2083 Coppia Protezioni in gommapiuma rivestita per impianto monotubolare
 Pair of soft protections for volleyball posts

IMPIANTO = coppia pali (rete esclusa)



Art. 1009
Impianto pallavolo a traliccio in alluminio
 ø mm. 120x100 completo di ruote e tendirete
 Volleyball posts in aluminium transportable with wheels, pipe section 120x100 mm.



Art. MB2236
Coppia protezioni in gommapiuma rivestita per impianto a traliccio
 Pair of soft protections for volleyball posts



Lato interno
 Inner side



Art. V5020
Impianto pallavolo a traliccio ø mm. 70 in acciaio zincato completo di ruote e tendirete
 Volleyball posts in galvanized steel, transportable with wheels pipe section 70 mm.

Art. 6740R
Impianto pallavolo a traliccio ø mm. 70 in acciaio verniciato completo di tendirete e ruote
 Volleyball posts in painted steel pipe section 70 mm. with wheels



Art. 6752/P
Coppia protezioni per impianto Pallavolo a parete
 Pair of soft protections for volleyball posts for wall fixing

Art. 6752/T
Impianto Pallavolo a parete
 Volleyball posts for wall fixing

pg.38

IMPIANTO = coppia pali (rete esclusa)

Art. V5029
Impianto pallavolo a tiranti ridotti in lega di alluminio profilo sezione mm. 120x100 con ruote per il trasporto piastra antitorsione alla base, arganello tendirete autofrenante senza cremagliera antinfortunistico
 Volleyball posts in aluminium transportable with wheels, pipe section 120x100 mm.





Art. E6532
Rete pallavolo economica m. 9,85
 Cheap net for volleyball

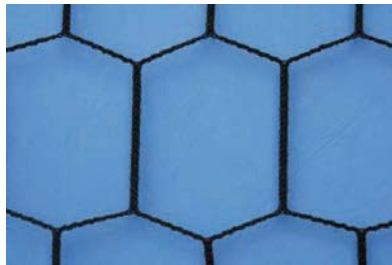

Art. P030
Rete pallavolo m. 9,50
 Net for volleyball

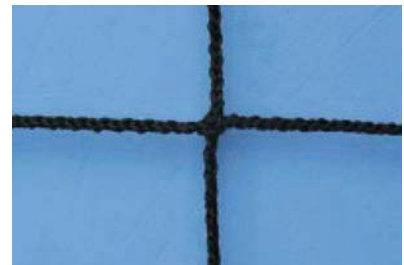

Art. P100
Rete pallavolo super pesante m. 9,50
maglia mm. 100
 Heavy net for volleyball

pg.38



Art. P110
Rete pallavolo extra pesante
m. 9,50 maglia mm. 100
a doppia fascia
 Heavy net for volleyball double band

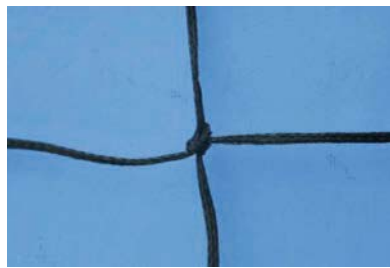

Art. P200
Rete pallavolo da gara
maglia mm. 100
con antenne e tasche
a norma FIPAV
 Official net for volleyball
 with sticks and fixing bands



Art. P201
Rete pallavolo da gara
maglia mm. 45
a norma FIPAV
per campionati di Superlega
(personalizzabile)
 Official net for volleyball
 (customizable)



Art. P14
Coppia antenne in vetroresina divise
 Fiberglass sticks in 2 pieces

Art. P15 Coppia
 tasche porta
 antenne cm. 5
 Fixing bands for
 sticks

Art. P16
Coppia antenne in
vetroresina intere
 One piece fiberglass
 sticks



Art. S04814
Segnapunti
manuale
girevole
a 4 cifre
 4 figure
 scoreboard



Art. PP054
Segnapunti manuale
da tavolo per Pallavolo bifacciale
(numeri da 0 a 50 non divisi)
 Volleyball table scoreboard



Art. PPP30
Segnapunti scolastico per Pallavolo
numeri da 0 a 30 rinforzati
 Volleyball school scoreboard





Art. 6768R
Seggiolone arbitro pallavolo in piedi, in acciaio verniciato, mobile su ruote
 Referee's stand made of painted steel, on wheels

pg.38



Art. S04804
Seggiolone arbitro pallavolo ad altezza fissa con scocca di seduta, in acciaio verniciato, mobile su ruote
 Referee's stand fixed height with plastic seat, made of painted steel, on wheels



Art. 1020
Seggiolone arbitro pallavolo approvato FIPAV regolabile in altezza con scaletta di accesso e ruote per trasporto
 FIPAV Referee's chair



Art. S04816
Serie 18 Palette per sostituzione giocatori con contenitore
 Set of 18 substitution indicators

Art. 089-V
Lavagna per pallavolo cancellabile cm. 35x25
 Volleyball Tactical Board erasable 35x25 cm.





Art. V5081
Simulatore di muro su ruote in acciaio, zavorrato, con pannello a superficie irregolare
 Portable wall in painted steel with irregular surface board

pg.38

pg.39



Art. V5082
Simulatore di muro portatile per squadre femminili e giovanili
 Portable wall for women and kids



Art. V5070
Ball Catcher cm. 70x70 altezza regolabile da cm. 190 a cm. 320 con anello superiore inclinabile, basamento zavorrato e retone inclusi
 Ball catcher, adjustable height and inclination (weighted base and net included)

Art. V5051
Jump Tester in acciaio zincato telescopico regolabile da cm. 230 a cm. 380 (basamento zavorrato non incluso)
 Jump Tester in galvanized steel telescopic adjustable height from 230 to 380 cm. (weighted base not included)

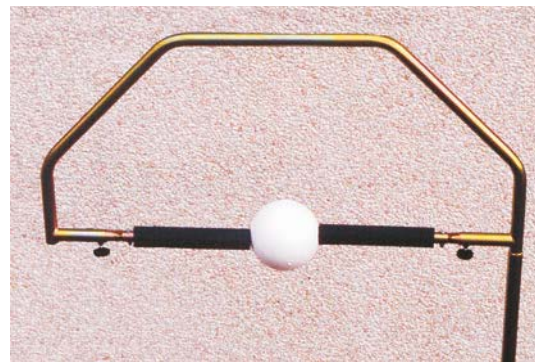

Art. V5060 Spike con ganasce (basamento zavorrato non incluso)
 (weighted base not included)

Art. V5050
Basamento zavorrato multiuso per Ball Catcher, Spike, Jump Tester
 Multi-purpose weighted base





Utilizzabile anche per Hit Ball



Art. BV20
Pallone Volley Trial in gomma supersoft
Supersoft Trial Volley ball
(also for Hit Ball)

pg.39

Art. V20
Pallone Volley Trial in gomma monostrato
Single stratum Trial Volley ball

Art. ULT20-3
Pallone Volley Trial in gomma triplo strato
Triple stratum Trial Volley ball

Art. MVBS
Pallone Volley School Mondo Under 13 peso ridotto
Under 13 Mondo Volley School ball

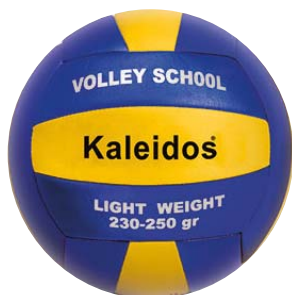

Art. E6835
Pallone Volley Soft Touch in PU saldato, regolamentare
Official size and weight Volley ball



Art. 18335
Pallone Volley Molten V5M2501-L Under 13 peso ridotto (ex Volley School)
Under 13 Molten Volley ball



Art. 29096
Pallone Volley Molten Ultra Touch V5M1500 allenamento
Molten Volley training ball



Art. 6036
Pallone Volley Molten V5M4000
Molten Volley ball



Art. 6331
Pallone Volley gara Molten V5M5000 "FLISTATEC" FIVB Approved
Molten Volley match ball

Art. BYCV
Pallone Volley Trial gomma bicolore
Trial bicoloured rubber Volley ball



Art. TRBV
Pallone Reaction Ball Trial doppio strato per Volley rimbalzo e traiettorie imprevedibili
Trial Volley ball for unpredictable rebounds



Art. USE20
Pallone Volley Trial gr. 405 (+50%) ø cm. 21 per allenamento potenziato
Rubber Trial heavier Volley ball

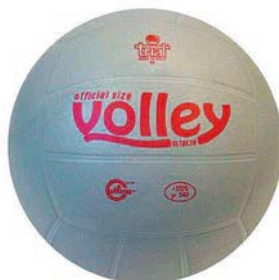

Art. ULTD20
Pallone Volley Trial gr. 540 (+100%) ø cm. 21 per allenamento potenziato
Rubber Trial heavier Volley ball

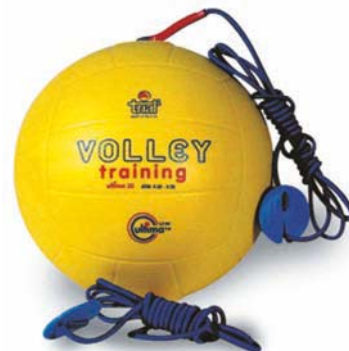

Art. ULT22
Pallone Volley Trial training con 2 elastici
Trial training Volley ball with 2 elastic ropes

MINIVOLLEY - SUPERMINIVOLLEY



Art. BV15
Pallone
PRIMO VOLLEY
Trial in gomma
supersoft
Trial supersoft
Volley ball

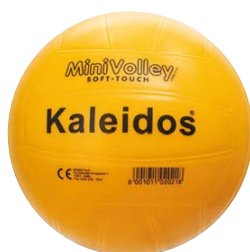

Art. 191S
Pallone MINIVOLLEY
in gomma Mondo
Mondo rubber Minivolley ball



Art. ULT15-3
Pallone PRIMO VOLLEY
Trial in gomma triplo strato
Trial triple stratum Volley ball

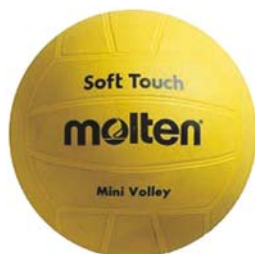

Art. 6332
Pallone MINIVOLLEY
in gomma Molten
Molten rubber Minivolley ball

pg.40



Art. V33
Pallone MINIVOLLEY
in gomma Trial
Trial rubber Minivolley ball



Art. V27
Pallone SUPERMINIVOLLEY
in gomma Trial
Trial rubber Superminivolley ball



Art. 991725/ ... /991728
Kit elastici allenamento pallavolo
soft/medium/hard/extra hard
Elastics for volleyball training
soft/medium/hard/extra hard



Art. ULT26-3 / ULT27-3
Pallone MINIVOLLEY/
SUPERMINIVOLLEY
in gomma triplo strato Trial
Trial triple stratum Minivolley/
Superminivolley ball



Art. MV70
Pallone MINIVOLLEY "First Touch"
Molten in nylon gr.70
(ad esaurimento)
Molten nylon Minivolley ball
(until available)

BEACH VOLLEY

Art. 1051 Impianto Beach Volley regolamentare in alluminio Ø mm.80 (rete esclusa) altezza rete regolabile anche per Beach Tennis
Beach volley posts in aluminium (net not included) adjustable height net also for Beach Tennis

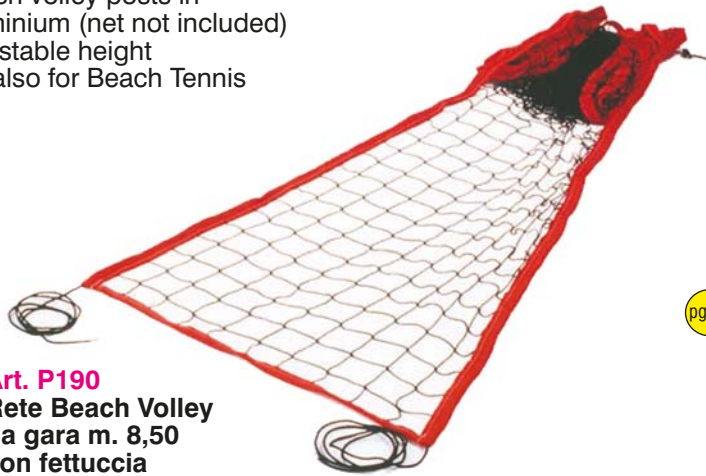

pg.40

Art. P190 Rete Beach Volley da gara m. 8,50 con fettuccia su tutto il perimetro
Beach volley match net

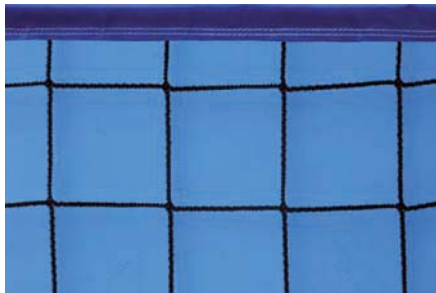

Art. P170 Rete Beach Volley m. 8,50 con fettuccia sul lato superiore
Beach volley net



Lato A Lato B

Art. BVMBP Coppia protezioni per impianto Beach Volley regolamentare altezza cm. 200 diametro cm. 8
Pair of Beach Volley posts soft protections

Art. V5513 Impianto Beach Volley in alluminio (rete esclusa) senza bussole altezza rete regolabile anche per Beach Tennis
Beach Volley posts in aluminium (net not included) with no sockets adjustable height net also for Beach Tennis



Art. V5510 Impianto Beach Volley in acciaio zincato (rete esclusa) altezza rete regolabile anche per Beach Tennis
Beach Volley posts in galvanized steel (net not included) adjustable height net also for Beach Tennis

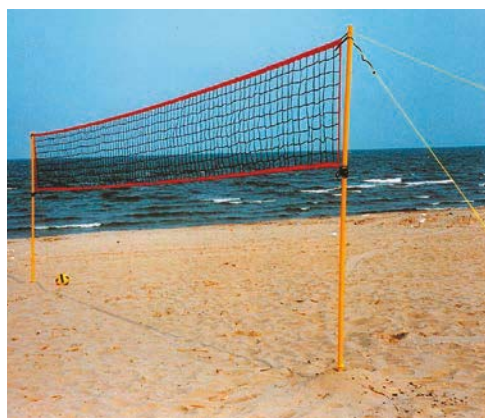

Art. F501 Impianto Mini Beach Volley portatile con pali telescopici in ferro verniciato completo di rete mt. 6,5x1 e sacca
Mini Beach Volley complete set





Art. V5543

Seggiolone per arbitro Beach Volley in acciaio ovale verniciato a polveri sez. mm.60 antinfortunistico e richiudibile in soli 45 cm.
Beach Volley referee's Stand

Art. V5428

Set imbottiture per seggiolone Art. V5543
Set of Soft Protections for Art. V5543

pg.40



Art. P17

Kit Delimitazione campo Beach Volley
2 nastri m.16 + 2 nastri m. 8 + 8 picchetti + 8 elastici
nastri larghezza mm. 50 occhiellati alle estremità
Set for Beach Volley Bounds

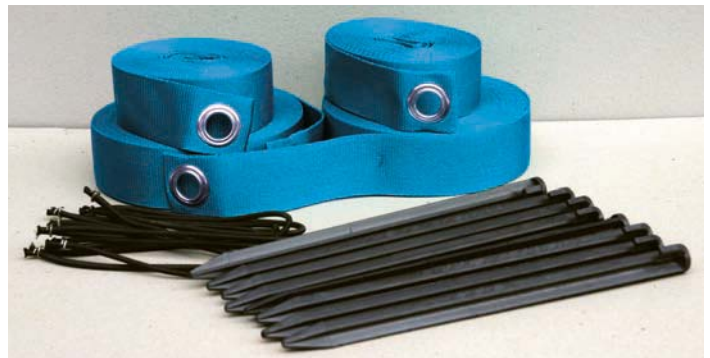

Art. P19 Kit Delimitazione regolabile per campo Beach Volley e Beach Tennis 2 nastri m.16 + 2 nastri m.8 oppure 2 nastri m.18 + 2 nastri m.9 colore blu
Set for Beach Volley and Beach Tennis bounds adjustable blue color



Art. M13719

Pallone Beach Volley Mondo BV 2000
in pelle sintetica
Mondo Beach Volley ball

pg.40



Art. 6340

Pallone Beach Volley da gara Molten V5B5000
Pallone ufficiale FIVB
Molten Beach Volley match ball



Art. 29097

Pallone Beach Volley Molten "Sweet Touch"
Molten Beach Volley ball

PROTEZIONI - Protections



pg.39

Art. E6644

**Paio ginocchiere Volley trapuntate misura S, M, L
colori royal, navy, nero, rosso, fucsia, giallo fluo, verde fluo**
Pair of knee protections size S, M, L



Art. E6645

**Paio ginocchiere Volley senza foro
posteriore con imbottitura modellata
JR e SR colori blu o nero**
Pair of knee protections for match size JR and SR



****Art. 9293**

**Paradenti singolo
taglia adulto**
Adult Mouthguard

****Art. 9293.B**

**Paradenti singolo
taglia bambino**
Junior Mouthguard

****Disponibili
anche senza
reggi-paradenti**



Art. 43602A

**Paradenti doppio
taglia S-L**
Double Mouthguard Size S-L



Art. E6641

**Paio ginocchiere Volley
regolabili con velcro, misura SR colori blu e nero**
Pair of pro knee protections size SR adjustable with
velcro - colors black and blue



Art. PDFOX

**Paradenti Fox singolo
taglia adulto - vari colori**
Adult Fox mouthguard - various colors



**Art. E6633 Paio gomitiere Volley, misura JR e SR
colori royal, rosso e nero**
Pair of elbow protections size JR and SR



pg.40



Art. ESPN

**Maschera di
protezione per
naso, zigomi
e arcata
sopracciliare**
Face Protection
Mask



Art. 73001
**Sospensorio
con conchiglia,
misura S, M, L**
Shell Protection
size S, M, L



Art. E6649

Art. E6650

Art. E6670

Art. E6649

Paio ginocchiere elasticizzate misura S-M-L-XL
Pair of elastic Knee Protections size S-M-L-XL

Art. E6650

Paio cosciere elasticizzate misura S-M-L-XL
Pair of elastic Thigh Protections size S-M-L-XL

Art. E6670

Paio cavigliere elasticizzate misura S-M-L-XL
Pair of elastic Ankle Protections size S-M-L-XL



Art. IS799
Ginocchiera
con supporti rigidi
taglia S/M - L/XL
Knee protection
with metal support



Art. E784
Ginocchiera in neoprene
traspirante taglia S-M-L
Neoprene Knee Protection



Art. E786
Cavigliera in neoprene
taglia S-M-L-XL
Neoprene Ankle Protection

pg.39



Art. AHF-075
Polsiera stabilizzante
in neoprene
con foro per il pollice
e chiusura regolabile
in velcro
Stabilizing neoprene
cuff with thumb hole
and adjustable velcro
closure

New!



Art. E798
Supporto Coscia
in neoprene
taglia S-M-L-XL
(XL ad esaurimento)
Neoprene Thigh
Protection



Art. 90252A
Fascia sottrotulea in neoprene
Neoprene underknee band



Art. 2651A
Short in neoprene
vita alta colore nero
taglia S-M-L-XL
Neoprene Shorts



Art. E796
Supporto gomito in neoprene
taglia unica regolabile
(ad esaurimento)
Neoprene Elbow Protection
one size fits all
(until available)

Art. AHF-079
Pancierina in neoprene
taglia unica 120x25x0,4 cm
Neoprene stomach band
25 cm. height



IMPIANTI MULTIFUNZIONE Multi-purpose systems



Art. S05206

Impianto multifunzione professionale per volley, minivolley, tennis e salto in alto - basi zavorrate in acciaio zincato su ruote gommare, ritti centimetrati in alluminio verniciato con cursore scorrevole
 Volley, Minivolley, Tennis and High Jump transportable system - galvanized weighted bases with wheels, posts in painted aluminium with slider

Art. S05208
Coppia tabelloni in plastica con canestro su supporto in acciaio per Art. S05206
 Pair of Basket Boards with baskets and steel back frames for Art. S05206



Art. S05209
Set protezioni per impianto multifunzione Art. S05206
 Soft Protection set for transportable system Art. S05206



pg.42

pg.43

Art. S05202

Impianto multifunzione volley, minivolley, badminton, tennis trasportabile zavorrato strutture verticali in acciaio zincato e verniciato, con ruote
 Volley, Minivolley, Badminton and Tennis transportable system



Art. S05204

Impianto multifunzione come Art. S05202 ma valido anche per basket (con tabelloni in plastica)
 Same of Art. S05202 but also for basket (with plastic boards)



Art. S05210
Rete per impianti multifunzione Art. S05202/S05204/S05206/PA020 dimensioni m. 9x1
 Net for multi-purpose systems size m. 9x1



Art. PA020
Impianto multifunzione trasportabile completo di protezioni

Volley, Minivolley, Badminton and Beach Tennis transportable system



Art. 6780M
Impianto volley e minivolley trasportabile zavorrato
 Weighted Volley and Minivolley transportable system

pg.38



Altezza rete (non inclusa) regolabile da cm. 91 a cm. 245
Basi in ABS con ruote, riempibili con sabbia



Art. 7800G
Coppia porte pallamano
in acciaio mm. 80x80
(reti escluse)
Pair of steel handball Goals

PALLAMANO - Handball

Art. 7801G
Coppia porte pallamano
in alluminio mm. 80x80
(reti escluse)
Pair of aluminium
handball Goals

Le reti per porte
pallamano
corrispondono
alle reti
per porte calcetto
m. 3x2
Same nets as futsal
goals m. 3x2



Art. SH1
Pallone Pallamano
Trial Micro/Midi Handball
per l'apprendimento
dei fondamentali
Trial Rubber Micro/Midi Handball
helps in learning the basics



Art. BA25 / BA0 / BA29 / BA30
Pallone Pallamano
Trial in gomma supersoft
junior / femminile
Handball supersoft
junior / size 2 in rubber



Art. M13651 / M13650
Pallone Pallamano
Mondo Golden
pelle sintetica
mis. 2 e mis. 3
Handball size 2 and 3
in synthetic leather

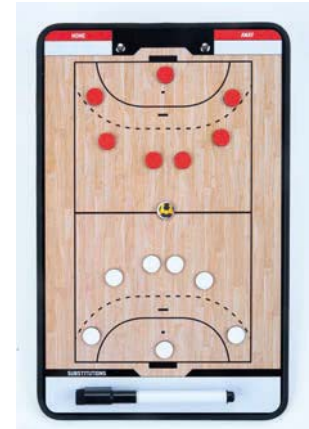

Art. PTI.HB
Lavagna Pallamano
bifacciale magnetica
e cancellabile cm. 35x22
Handball tactical board



**Art. V29 / V30 / V49 / ULT49-3 / ULT30-3
ULT303.15 / ULT29-3 / ULT24-3**
Pallone Pallamano in gomma
Trial (mono e triplo strato) mis. 0-1-1,5-2-3
Trial Handball in rubber (single and triple stratum)
size 0-1-1,5-2-3

pg.40

pg.41



Art. ULT34 / ULT35 / ULT36-3 / ULT37-3
Pallone Beach Handball in gomma Trial triplo strato
mis. 00, 0, 2, 3
Trial Beach Handball in rubber size 00, 0, 2, 3

**Art. ULTS29 / ULTD29
ULTS30 / ULTD30
ULTS49 / ULTD49**
Pallone Pallamano
gomma Trial
potenziato
Ø 15/17/18,5 cm.
gr. 375/500/550/630/
700/750 (+50% / +100%)
Rubber Trial Heavier Handball



Art. TRBH
Pallone Reaction Ball Trial
doppio strato
rimbalzo e traiettorie imprevedibili
Trial Reaction Ball unpredictable
rebounds - for Handball



Art. BYCH
Pallone Pallamano
bicolore gomma Trial
Ø cm. 18,5 gr.420
Trial bicoloured
Handball

TABELLONI ELETTRONICI BASKET, PALLAVOLO, MULTISPORT Electronic scoreboards for basketball, volleyball, multisport

pg.36



Art. F160

Tabellone portatile MULTISPORT da tavolo con tastiera di comando per BASKET, VOLLEY, CALCETTO, PALLANUOTO, PALLAMANO, KICK BOXING, PING PONG ed altro punteggi da 0 a 199 per lato set/bonus/falli da 0 a 9 per lato cronometro massimo 99 minuti e 59 secondi periodi da 0 a 9 - altezza cifre cm.9 dim. cm. 55x35x9,5
Multisport Table Scoreboard (for BASKET, VOLLEY, FUTSAL, WATER POLO, HANDBALL, KICK BOXING, TABLE TENNIS)



Art. F345

Tabellone elettronico PLAY30-V con console solo tasti e m. 30 di cavo - dim. cm. 85x38x11 h. cifre cm. 17,4 - indicato per VOLLEY, PING PONG, BADMINTON, SQUASH punteggi 0-199 per lato - set/bonus da 0 a 9 per lato - possesso/priorità/turno lato dx o sx Electronic Board with console, dim. 85x38x11 cm. 17,4 cm. high figures



Art. F351D

Tabellone MULTISPORT PLAY30-C con console a display luminoso per BASKET, VOLLEY, CALCETTO, PALLAMANO ed altro punteggi da 0 a 199 per lato - set/bonus/falli da 0 a 9 per lato - cronometro 99 minuti e 59 secondi altezza cifre punteggio cm.17,4 - altezza cifre cronometro cm.15 - segnalazione acustica di fine tempo dim. cm.75x59x10 - Peso Kg.12,4 cavo console 60 metri
Multisport scoreboard PLAY30-C dim. 75x59x10 cm.



pg.37

Art. F300-14

Cronometro da esterno (minuti + secondi) dim. cm.166,5x59x15 - h. cifre cm. 45 con console
Timer for outdoor with console



Art. F3045015

Tabellone MULTISPORT dimensioni cm.91x60x9,5 peso Kg.10 - utilizzabile per BASKET, VOLLEY, CALCETTO, PALLAMANO, PALLANUOTO, TENNIS, PING PONG, BADMINTON altezza cifre cm.15 - visualizzazione di punteggi, cronometro, timeout, falli squadra, periodo, possesso palla.

Console Art. F307-01 o Art. F308-01 non inclusa

Electronic Board, dim. 91x60x9,5 cm.

15 cm. high figures for various sport.

Console Art. F307-01 or Art. F308-01 not included

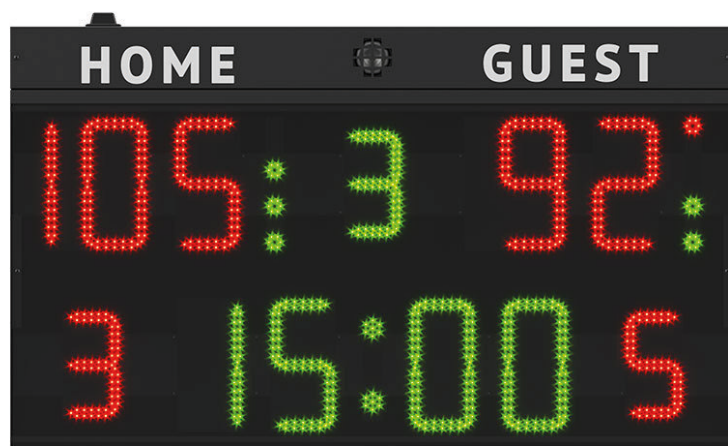

Art. F3045025

Tabellone segnapunti MULTISPORT

Omologato FIBA livello 3

(BASKET, VOLLEY, CALCETTO, TENNIS, PING PONG, PALLAMANO, PALLANUOTO, BADMINTON)

altezza cifre cm.25 distanza di leggibilità m.110

peso Kg.22 - dimensioni cm.140x83x9

da utilizzare con console Art. F308-01 (non inclusa)

Electronic Board, dim. 140x83x9 cm.

25 cm. high figures for various sport.

Console Art. F308-01 not included



Art. F268-02

Kit indicatori elettronici 24-30 secondi wireless

h. cifre cm.20 - dim. cm.28,5x32x10 cadauno

completo di console Art. F308-01

visualizzazione del tempo di tiro segnalatore acustico di fine tempo

Kit 24 second indicators wireless with console Art. F308-01

pg.36



Art. F307-01

Console 300 per Art. F3045015

Display LCD - utilizzabile per collegamento via cavo

dim. cm.28,5x10,5x8

Console for Art. F3045015 with cable system



Art. F308-01

Console 700 per Art. F242,

Art. F3045025 e Art. F3045015

Display touchscreen - utilizzabile per collegamento sia via cavo che via radio

dim. cm.24,5x17x8,5

Console for Art. F242, Art. F3045025 and Art. F3045015 with cable or radio system

pg.37

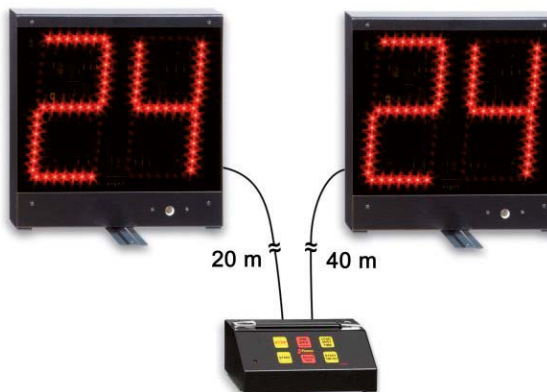

Art. F270

Kit indicatori elettronici 24 secondi

h. cifre cm.20 - dim. cm.29,2x30,4x4,4 cadauno

completo di centralina munita di tastiera

visualizzazione del tempo di tiro e del timeout

segnalatore acustico di fine tempo, un cavo m.20

e un cavo m.40 in dotazione

Kit 24 second indicators with console



Art. F242

Tabellone MULTISPORT FS-130
 dimensioni cm.200x180x9 - peso Kg.60
 costruito secondo le disposizioni FIBA
 utilizzabile per BASKET, VOLLEY, CALCETTO,
 PALLAMANO, HOCKEY, TENNIS, PALLANUOTO
 altezza cifre cm.30 tempo di gioco 99:59
 punteggi di squadra (da 0 a 199) - periodo (0 - 9)
 falli di squadra/set vinti (da 0 a 9) - bonus
 (1 punto luminoso per squadra)
 timeout (3 punti luminosi per squadra)
 possesso/servizio/turno: frecce indicatrici
 indicazione ultimo fallo avvenuto
 (numero di maglia del giocatore e numero del fallo)
 Console Art. F308-01 non inclusa
 Electronic Board, dim. 200x180x9 cm.
 30 cm. high figures for various sport
 Console Art. F308-01 not included



Art. F258-51

**Tabellone elettronico indicatore dei
 24 secondi e tempo di gioco FS-24s-1**
 dim. cm.70,5x60x11,5 h. cifre cm.14
 e cm.30 - da collegare con
 Art. F253-21, completo di cavo m.50
 per collegamento alla console
 Art. F308-01 - protetto contro gli urti
 della palla - *N.B. Per un impianto
 Basket completo occorrono
 n. 2 Art. F253-21 + n. 2 Art. F258-51*
 24 second indicator board



pg.37

Art. F308-01

**Console 700 per Art. F242,
 Art. F3045025 e Art. F3045015**
 Display touchscreen - utilizzabile per
 collegamento sia via cavo che via radio
 dim. cm.24,5x17x8,5
 Console for Art. F242, Art. F3045025
 and Art. F3045015 with cable or radio system

Art. F253-21

**Kit cornice
 luminosa e
 centralina di
 comando per
 tabellone basket
 Ledstrip cm.515**
 Kit light frame and
 control unit for
 basketball board
 Ledstrip 515 cm.

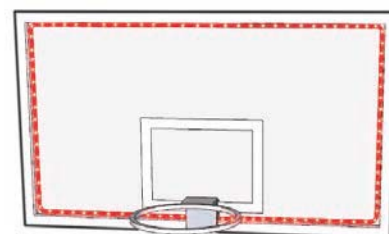

pg.37



Art. F265-20

**Ricevitore radio per collegamento del
 tabellone indicatore 24 secondi**
 Art. F258-51 alla console Art. F308-01
*N.B. Per un impianto
 Basket completo occorrono
 n. 2 Art. F253-21 + n. 2 Art. F258-51
 + n. 2 Art. F265-20*
 Radio receiver connecting
 Art. F258-51 to Art. F308-01



Art. F300-26

Tabellone elettronico da esterno
 ideale per CALCIO, CALCIO RIDOTTO E CALCETTO
 dim. cm.166,5x118x15 - altezza cifre 45cm.
 Punteggio squadre da 0 a 9 - Cronometro 99:59
 orologio - resistente agli urti della palla,
 da utilizzare con console Art. F308-01 (non inclusa)
 Electronic scoreboard for outdoor - ideal for Soccer,
 Futsal - resistant to ball hits
 (console Art. F308-01 not included)

TENNIS - PADEL

Art. 8820G
Coppia Pali Tennis in acciaio verniciato a sezione quadra con bussole da interrare e tendirete
Tennis Posts in painted steel with underground sockets

Art. 1058
Coppia Pali Tennis da fissare al pavimento in acciaio verniciato a sezione quadra e tendirete in bronzo ad arganello
Tennis Posts in painted steel for ground fixing

Art. 1059
Coppia Pali Tennis da fissare al pavimento in alluminio e tendirete in bronzo ad arganello
Tennis Posts in aluminium for ground fixing

Art. 1056
Coppia Pali Tennis in acciaio zincato e verniciato a sezione quadra con bussole da interrare e tendirete in bronzo ad arganello
Tennis Posts in galvanized and painted steel with underground sockets

● pg.41 ● pg.42



Art. 8819G
Coppia Pali Tennis in alluminio con bussole da interrare e tendirete
Tennis Posts in aluminium with underground sockets

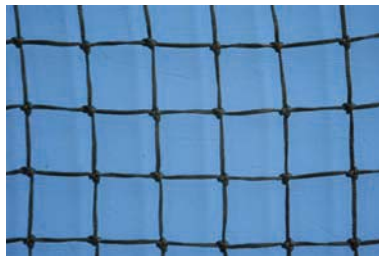

Art. T030
Rete Tennis annodata m.12,80 x 1 - sp. mm. 2,5 (centro rete non incluso)
Tennis knotted net (Art. RT1 not included)



Art. T040
Rete Tennis da gara annodata modello Wimbledon m.12,80 x 1 - sp. mm. 3,5 (centro rete Art. RT1 non incluso)
Tennis knotted match net (Art. RT1 not included)

Art. RT1
Centro rete
Net central holder

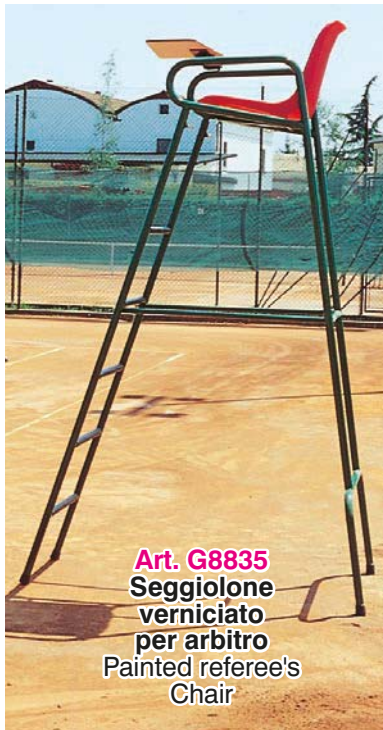

Art. G8835
Seggiolone verniciato per arbitro
Painted referee's Chair



Art. TE10030
Impianto Junior Tennis cm. 500x100 in acciaio trasportabile (rete esclusa)
Transportable junior Tennis posts in steel (net not included)

Art. TE10031
Rete per impianto Art. TE10030
Net for Art. TE10030



Art. S04862
Impianto Tennis in acciaio zincato trasportabile (rete e zavorra escluse)
Transportable Tennis posts in galvanized steel (net and weights not included)



Art. S04868
Coppia paletti per singolo in acciaio verniciato
Pair of steel poles for single



Art. RTAD / RTB912 / RTB58
Racchetta Tennis Dunlop in lega
 27" (adulti) - 25" (9/12 anni) - 23" (5/8 anni)
 Tennis rackets



Art. AGDP
Tube 3 palle Tennis
depressurizzate
 Dunlop
 (rimbalzo ridotto
 del 50% per scuole
 tennis)
 Set 3 depressurized
 Tennis balls

pg.41 pg.42



Art. 44.045 Over Grip



Art. E6620
Paio Polsini
 tergisudore
 altezza cm. 7
 Pair of
 Wrist bands



Art. E6610
Fascia
 tergisudore
 altezza cm. 5
 Headband



Art. T4D
Tube 4 Palle Tennis
 Head Championship
 Set 4 Tennis Balls



Art. T4DAC
Tube 4 Palle Tennis
 Dunlop Fort All Court
 Set 4 Tennis Balls



Art. TPAPD
Tube 3 Palle Padel
 Dunlop Team
 Set 3 Padel Balls

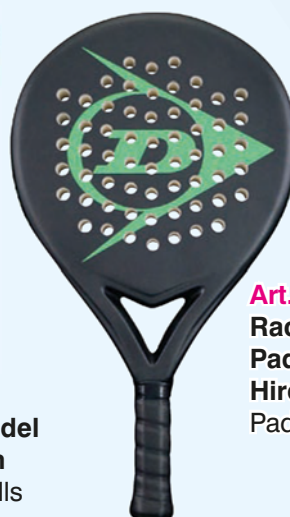

Art. T043
Rete PADEL
 m.10x0,92
 Padel net

New!

Art. RPDH
Racchetta
 Padel Dunlop
 Hire
 Padel Racket

Art. 07861 Set 3 palline tennis in gommapiuma
 Set 3 foam rubber tennis balls



Art. 48018
Racchetta Beach Tennis in resina
 (il colore e la grafica possono variare)
 Beach Tennis racket

pg.42



Art. PT41
Pallina Beach Tennis
 Beach Tennis ball

BEACH TENNIS



Art. P210
Rete Beach Tennis
 con fettuccia su tutto
 il perimetro
 Beach Tennis net



Art. TE220.40 Macchina lancia palline
velocità max 130 km/h
velocità min 30 km/h
frequenza lancio da 2 a 15 secondi
Ball throwing machine



Art. TE51.04
Rullo in acciaio con racla
Levelling roller



Art. RT10046
Cestino raccogli-palle
con manici ribaltabili
Ball collection basket with
folding handles



Art. RT10
Stuoia livellatrice per campi in terra
battuta m.2x1,5
Levelling net m.2x1,5

pg.42

Art. RT3
Rotolo m. 150
strisce segnacampo
Tennis in PVC mm. 50
150 m. set
Tennis lines in PVC



Art. 0934N
Rete protezione
polietilene verde annodata
maglia cm. 4,5x4,5 sp. mm. 2
Protection Net green polyethylene
mesh 4,5x4,5 cm.
knotted, thick 2 mm.



Art. 40/S - 41/S
Telo fondo campo Tennis
densità 90% o 70% mt.18x2
con banda di rinforzo
Tennis perimeter net density
90% or 70% dim. 18x2 meters



Art. TE53083
Tabellone segnapunti Tennis
cm. 100x77 h. cifre cm. 12
completo di agganci per la recinzione
Tennis scoreboard 100x77 cm.



Art. F166PST
Tabellone
elettronico
portatile da tavolo
per Tennis
Portable Tennis
electronic
scoreboard

TENNIS TAVOLO - Table Tennis



Art. TEC.I
Tennis tavolo Tectonic indoor per interno
Indoor Table Tennis Tectonic

Art. TEC.O
Tennis tavolo Tectonic outdoor per esterno
Outdoor Table Tennis Tectonic



Art. C250.I
Tennis tavolo Cornilleau modello Sport 250 da interno
Indoor Table Tennis Cornilleau Sport 250

pg.43



New!

Art. C200X.O
Tennis tavolo Cornilleau modello Sport 200X da esterno
Outdoor Table Tennis Cornilleau Sport 200X



Tutti i tavoli sono pieghevoli e su ruote
All models are foldable and on wheels



New!



Art. C500X.O
Tennis tavolo Cornilleau
modello 500X da esterno
Outdoor Table Tennis
Cornilleau 500X

● pg.43



Art. C500.I
Tennis tavolo Cornilleau
modello 500 da interno
Indoor Table Tennis
Cornilleau 500



Art. C510.O
Tennis tavolo Cornilleau
modello 510 da esterno
Outdoor Table Tennis
Cornilleau 510



Art. 568001
Racchetta
Ping Pong
Dunlop
Nitro
 (o modello simile)
 Dunlop
 table tennis bat



Art. 83925A
Racchetta
Ping Pong
Dunlop
Evolution 1000
 (o modello simile)
 Dunlop
 table tennis bat



Art. 48441
Confezione 6 Palline
Dunlop Championship
 Set of 6 table tennis balls



Art. 2C4118C
Confezione 100 Palline
1 stella colore bianco
 Set of 100 table tennis balls

pg.43



Art. 17362
Confezione 3 Palline
Stiga 3 stelle Perform
 Set of 3 Stiga table tennis balls



Art. PP50
Rete in polietilene
 Table Tennis Net



Art. E5019
Rete Ping Pong
regolabile portatile universale
 Table tennis net adjustable length



Art. 48448
Set rete con paletti
 Table Tennis Net
 with holder



Art. PPP30
Segnapunti per Ping Pong con numeri da 0 a 30 rinforzati
 Table tennis scoreboard

RUGBY



Art. 8836G1 / 8836G
Coppia Porte Rugby
in alluminio verniciato
m. 11 / m. 9,6 fuori terra
Rugby Goals
in painted aluminium

Art. 993156/993157/993162
Protezione imbottita per palo porta rugby
h. cm. 200, modello
quadrato oppure tondo
Soft Protection for rugby goal post, square
and round shape, height 200 cm.



Art. M13537
Pallone rugby
Mondo Touche
in gomma
(disponibile fino ad esaurimento scorte)
Mondo rubber rugby training ball
(until available)

pg.44



Art. V71
Pallone mini-rugby Trial
in gomma monostrato
gr. 350 dim. cm.15/27
Trial rubber mini-rugby Ball
single stratum



Art. ULT71
Pallone mini-rugby Trial
in gomma doppio strato
gr. 350 dim. cm.15/27
Trial rubber mini-rugby Ball
double stratum

Art. ULT70
Pallone rugby Trial
in gomma doppio strato
gr. 450 dim. cm.19/28
Trial rubber rugby Ball
double stratum



Art. F1645X
Pallone football americano
in pelle sintetica
Wilson Extreme ball

pg.44

Art. 993164
Protezione copri bandierina
cm.10x10x100h.
Protection for rugby flag pole,
10x10x100 cm.



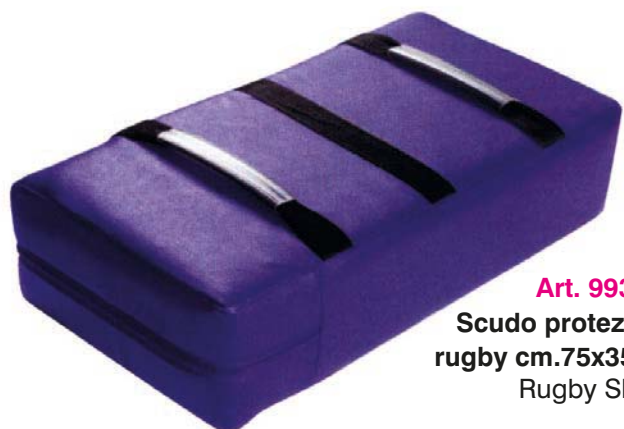

Art. 993032
Scudo protezione
rugby cm.75x35x15
 Rugby Shield



Art. 6M18
Confezione 100 Tacchetti rugby
mm.18 in alluminio
 Rugby aluminium studs
 18 mm. 100 piece pack



Art. 993151 / 993153JR
Sacco placcaggio rugby h. cm.140 o cm.120
diam. cm. 45 o cm. 35, con 3 maniglie
 Sac for Tackling height 140 or 120 cm.
 diameter 45 or 35 cm. with 3 handles

pg.44



Art. PTI.RU
Lavagna Rugby bifacciale
magnetica e cancellabile
cm. 35x22
 Rugby tactical board
 35x22 cm.

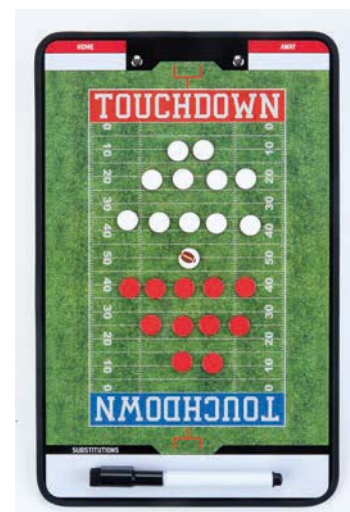

Art. PTI.FA
Lavagna Football
Americano bifacciale
magnetica e cancellabile
cm. 35x22
 Football tactical board
 35x22 cm.



Art. FLFT
Kit Flag Football composto da cintura regolabile e 2 flag - vari colori
 Flag Football kit with adjustable belt and 2 flags - various colors

PISCINA - Swimming Pool



Art. E1901
Cuffia in poliester
(bicolore solo taglia adulto)
Polyester cap

pg.43



Art. E1904
Cuffia in lycra
Lycra cap



Art. E1127
Cuffia in silicone
Silicone cap



Art. E2607
Stringinaso con
cuscinetti in silicone
Silicone nose-clip



Art. E2608
Tappi auricolari in silicone
automodellanti - Set da 4 pz.
Silicone auricular plugs



Art. E2620
Occhialini
da piscina Junior
Junior glasses



Art. E2626
Occhialini
da piscina adulto antifog
monococca morbida
Senior antifog glasses



Art. E2618
Occhialini da piscina adulto antifog
monococca morbida
custodia con cerniera
Senior soft antifog glasses
case with zip



Art. E2622
Occhiale maschera
antifog monococca morbida
con custodia rigida
Mask glasses antifog with case



Art. E2639
Tavoletta per piscina adulto
professionale cm.40x27
Senior professional board



Art. E2641
Ostacolatore monoblocco
cm.15x22x7,5
Swim hinder



Art. E2650
Paio palette palmari forate
cm.21x16 (misura S, M, L)
Pair of perforated palm palettes



Art. E2660
Copriscarpe in PVC
set da 2000 pezzi
misura unica
PVC shoe covers



Art. E848
Marsupio per nuoto potenziato
Swimming pouch

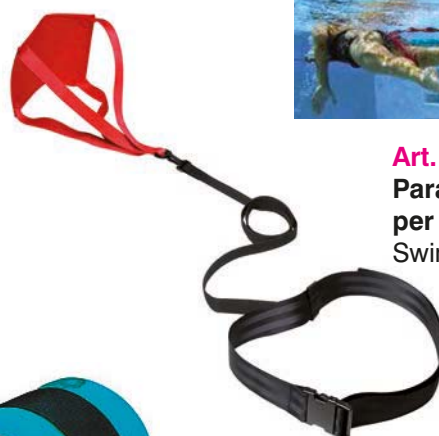

Art. E845
Paracadute per nuoto potenziato
Swimming parachute



Art. E482
Paio polsiere/cavigliere per aquagym mis. cm. 62x11x2
Water aerobics wrist/ankle supports



Art. E483
Paio manubri per aquagym cm.30 - diam. cm.14
Water aerobics dumb bells

● pg.43 ● pg.44



Art. E474
Paio clavette per aquagym
Water aerobics clubs



Art. E488
Cintura per aquagym cm.72x24x4
Water aerobics belt



Art. E479/3
Zattera in espanso forata dim. cm.200x100x3
Pierced mat



Art. E470
Cilindro in materiale espanso per aquagym cm. 160 ø cm. 7
Water aerobics bar



Art. E2637/0
Paio manicotti arrotolabili doppia valvola (3/6 anni)
Brackets



Art. E480/1
Connettore per cilindro mis. cm.14 - 2 fori
Bar connector



Art. AQSA
Step per aquagym impilabile ad incastro cm.70x35x19
Water aerobics step cm.70x35x19

PALLANUOTO - Waterpolo

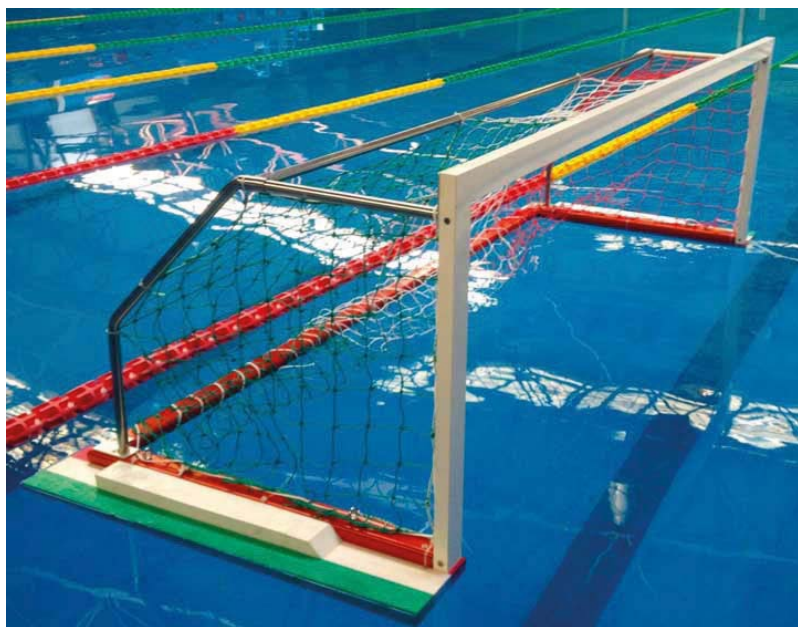

Art. PPNR

Coppia Porte da pallanuoto per partite ufficiali (reti incluse)

Pair of Waterpolo Goals for official matches (nets included)

- Realizzate a norma F.I.N.A.
- Luce interna specchio di porta m.3x0,90
- Ingombro totale m.3,50x0,975x1,25
- Specchio di porta tubolare alluminio mm.75x40x1,85 di colore bianco
- Base tubolare alluminio mm.80x40x3 colore rosso
- Accessori acciaio inox AISI 316
- Galleggianti schiuma espansa a cellule chiuse densità 350% - Peso kg.30

Art. 175P

Coppia reti per porte pallanuoto

Waterpolo Nets

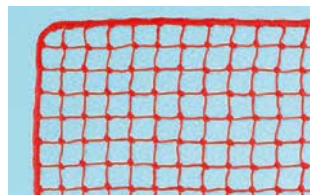

● pg.43



Art. AQPP

Coppia Miniporte da pallanuoto in PVC m. 1,5x0,8 complete di reti

Pair of Waterpolo PVC Mini-goals 1,5x0,8 m. nets included



Art. E6890

Pallone pallanuoto

Waterpolo Ball



Art. 30415

Set 13 cuffie pallanuoto con numero colore bianco o blu

Set of 13 Waterpolo caps with numbers

BADMINTON



Art. P160
Rete
Badminton
cm. 610x70
Badminton Net

V7700
Impianto Badminton
professionale in acciaio verniciato
zavorrato, su ruote, con tendirete
(rete esclusa)
Pro Badminton set (net not included)



Art. 23461
Racchetta Badminton
in acciaio/alluminio
Badminton Racket
in steel/aluminium

pg.45



Art. PAC12
Racchetta Badminton
in grafite/alluminio
Badminton Racket
in graphite/aluminium



Art. 22309
Confezione
6 Volani
Badminton
interamente
in plastica
Plastic
Shuttlecock
6 piece pack

Art. AS85
Confezione
6 Volani
Badminton
con capsula
in sughero
Cork tip
Shuttlecock
6 piece pack

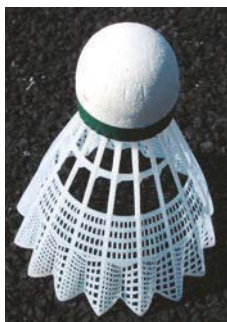

Art. JIN
Impianto
Mini Badminton
mt. 4,20x1,50
telescopico portatile
completo
di rete e borsa
Portable Mini
Badminton
set mt. 4,20x1,50
with net and bag

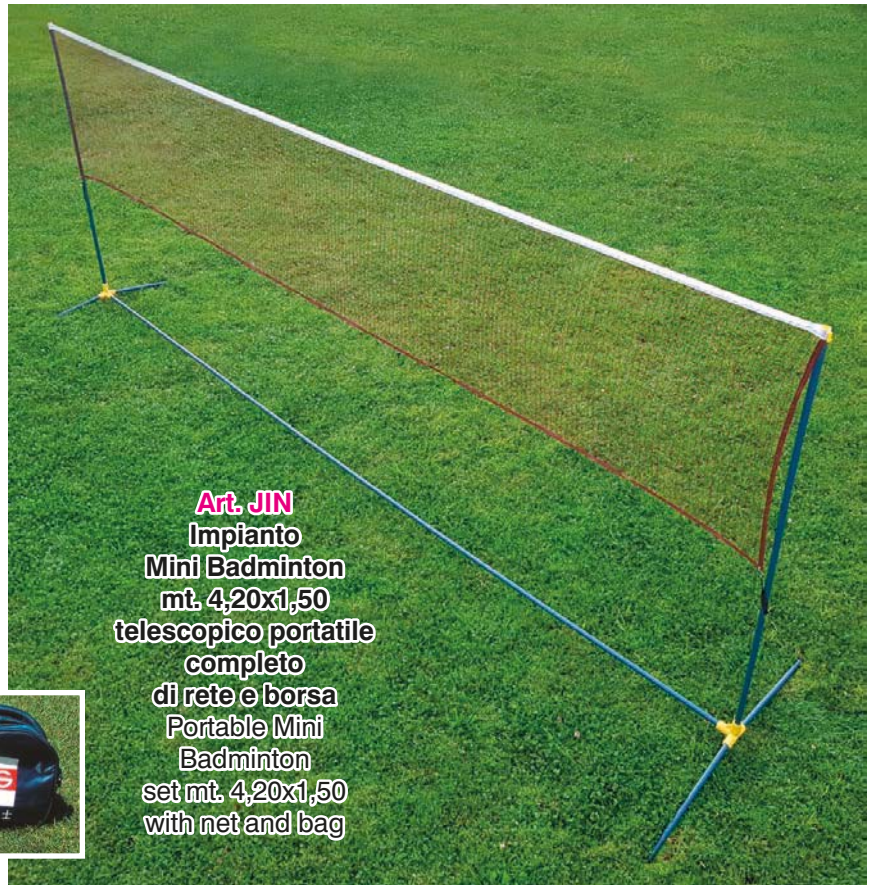

HOCKEY



Art. S05128

**Coppia porte per Hockey su pista
in acciaio verniciato**
Pair of Hockey Goals in painted steel



Art. S05122

**Coppia porte per Hockey su prato
in legno e acciaio verniciato**
Pair of Hockey Goals in wood
and painted steel



Art. PUH01
Pallina Unihockey
Unihockey ball

pg.44

Art. F806

**Coppia porte Unihockey
in acciaio verniciato con reti,
dim. cm.150x110**
Pair of Unihockey Goals in painted steel 150x110 cm.



Art. S05134

**Set Unihockey composto
da 6+6 bastoni cm.80+10 e 3 palline**
Set Unihockey made of 6+6 sticks and 3 balls

Art. H1

**Coppia RETI per porte da Hockey pista
(indoor) in polipropilene maglia mm.45
cm.300x200x100x100**
Pair of Track Hockey Goal nets

Art. H2

**Coppia RETI per porte da Hockey
ghiaccio in polipropilene complete di rete
di sbarramento, maglia
mm.20 - cm.193x122x75x120**
Pair of Ice Hockey Goal nets

Art. H3

**Coppia RETI per porte da Hockey
prato in polipropilene complete di rete
di sbarramento, maglia
mm.45 - cm.366x214x90x122**
Pair of Field Hockey Goal nets

Art. H4

**Coppia RETI per porte da Hockey rotelle in
polipropilene complete di rete di sbarramento,
maglia mm.20 - cm.185x122x74x110**
Pair of Roller Hockey Goal nets

BOXE



Art. 992030
Sacco Boxe in vinile Kg.30
Vinyl boxing bag kg.30



Art. 992040
Sacco Boxe in vinile Kg.40
Vinyl boxing bag kg.40



Art. 992050
Sacco Boxe in vinile Kg.50
Vinyl boxing bag kg.50



Art. C3003S
Gancio a molla
ammortizzatore per
sacco boxe
Spring for boxing bag

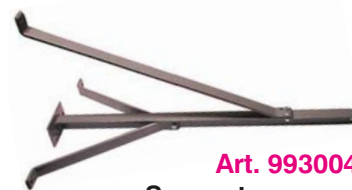

Art. 993004
Supporto a muro
per sacco boxe
Iron wall support for
boxing bag



Art. 992840
Sacco Boxe basculante
h. cm. 170 zavorrato con
sacchi di sabbia (inclusi)
Self-straightening boxing bag
height cm.170



Art. 992804
Sacco Fit Boxe con pedana
riempibile con acqua o sabbia,
altezza regolabile (max cm. 220)
Freestanding Fit Boxing bag
adjustable height



Art. F350
Kit pera
su mensola
Pear for boxing

pg.52



Art. 42233A
Casco Boxe
misure S,M,L,XL
Boxing helmet



Art. 44613A
Set protezioni
parastinco +
parapiede
misure S,M,L,XL
Shin/foot protections



Art. 17211
Coppia Fasce Boxe
Boxing bandages

pg.52



Art. 54613A
Guanti da Sacco in PU
taglie S,M,L,XL
Bag gloves



Art. 21796
Guanti Fit Boxe
taglie S,M,L,XL
Fit Boxing gloves

pg.53



Art. 74613A
Guanti MMA in PU
taglie S,M,L,XL
MMA gloves



Art. 84613A
Guanti Boxe
per combattimento
non omologati
8/10/12 oz.
Boxing gloves



Art. GN083
Guanti Boxe
Leone Flash 10 oz.
Leone Boxing
gloves

BASEBALL



Art. TMB01
Mazza Baseball supersoft Trial
 lunghezza cm.71 diametro cm.4/5
 peso gr.460
 Supersoft Trial Baseball bat



Art. S05152
Mazza Baseball regolamentare in legno
 Wooden Baseball bat



Art. S05156
Palla Baseball rivestita in pelle sintetica
 Baseball ball

pg.45

Art. PTI.BB
Lavagna Baseball
 bifacciale magnetica
 e cancellabile
 cm. 35x22
 Baseball
 tactical board
 35x22 cm.



Art. S05158
Guantone Baseball
 in pelle sintetica
 misura senior
 Senior Baseball glove

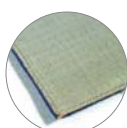

appoggio
 antiscivolo



imbottitura
 interna



Art. P21006
Set basi didattiche
 antiscivolo colorate
 Set of didactic anti-skid
 bases

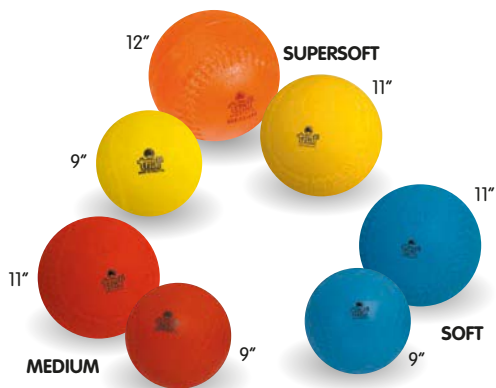

Art. BSB.8
Set 7 Palle Baseball/Softball
Trial in gomma super soft
 diametri e grammature
 assortiti
 Set of Trial Baseball/Softball
 balls



Art. T21063
Batting tee Trial
 supersoft
 altezza regolabile
 da cm. 65 a cm. 86
 base diametro cm. 20,5
 peso Kg. 3
 Trial Batting tee
 adjustable height

ARTI MARZIALI - Martial Arts



Art. 24772
Divisa judo con cintura
misure da 00 (cm.120)
a 7 (cm.200)
Judo strip with belt

pg.53



Art. 24773
Divisa karate con cintura
misure da 00 (cm.120)
a 7 (cm.200)
Karate strip with belt



Art. 23271
Cintura judo/karate 100% cotone
colori: nero, blu, arancio, marrone, verde, giallo, rosso
misure da 1 a 7
Judo/Karate belt



Art. 23271.B
Cintura judo/karate 100% cotone
bicolore: bianco/giallo, giallo/arancio,
arancio/verde, verde/blu,
blu/marrone - misure da 1 a 7
Bicoloured Judo/Karate belt



Art. F163
Tabellone elettronico
portatile da tavolo
per Kick-Boxing
Kick-Boxing portable
electronic
Scoreboard



Art. F162
Tabellone elettronico
portatile da tavolo
per Karate
Karate portable
electronic
Scoreboard

Art. F150
Fight Timer da parete
cm.56x19x4 - kg.1,6
Fight Timer



MATERASSI - TAPPETI - Mats



Art. B2001/ ... /B2016

Materassi di caduta realizzati in gommapiuma di varie densità con fodera di rivestimento in PVC antimuffa, antibatterico, ignifugo Cl.2

(vedere listino per le dimensioni)

Mats of various dimensions and thickness

Materassi e fodere disponibili anche con fondo antiscivolo (dettagli sul listino prezzi)

Mats and covers also available with anti-skid bottom (details on the price list)

pg.45

pg.46

pg.47

Art. B2033/ ... /B2047

Fodere di ricambio in PVC antimuffa, antibatterico, ignifugo Cl.2

(vedere listino per le dimensioni)

Spare covers for mats various dimensions



Particolare Art. B2014/ B2015/B2016

(i materassi cm.200x400 sono costituiti da 2 pezzi tagliati a 45° e tenuti insieme da bande in velcro)



Art. B2214/ ... /B2219

Materassi di caduta pieghevoli (vedere listino per le dimensioni)

Foldable Mats



pg.47

Art. B2228/ ... /B2231

Tappeti Gym Mat dim. cm.200x100 spessore cm.3-4-5-6 ad alta densità in polietilene a cellule chiuse (per uscita attrezzi)
High density Gym Mats

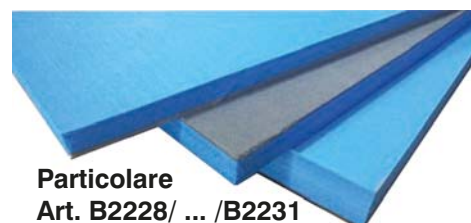

Particolare Art. B2228/ ... /B2231

Più rigidi
dei materassi in gommapiuma
Harder than foam rubber mats

Art. S00676
Carrello porta materassi
cm. 200x100
in acciaio verniciato
mobile su ruote
Mat Trolley in painted steel size
200x100 cm. on wheels



pg.46



Art. S00678
Carrello porta materassi
in verticale cm. 250x105
in acciaio verniciato
mobile su ruote
(elastici inclusi)
Vertical mat Trolley in painted
steel size 250x105 cm.
on wheels
(elastics included)



pg.47

Art. TEST.M
Tappeto Mat Test cm.100x370
con scala centimetrata da 0 a cm. 300
Mat Test 100x370 cm.

Per allenamento tuffi portieri ed acrobazie giocatori
For GK dive and players' acrobatic shooting training

pg.45

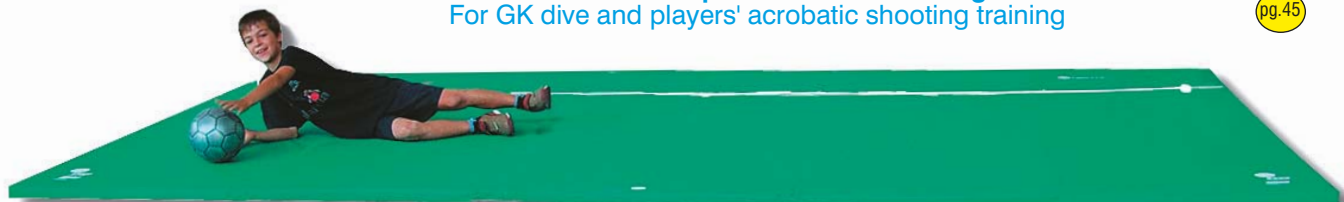

Art. BGAP13
Tappeto ammortizzante pieghevole dimensioni cm. 200x450 spessore cm. 3,5
superficie in vinile, fondo antiscivolo, imbottitura in gommapiuma densità 40 Kg/mc
Foldable soft mat for goalkeeper and players' safe dives - size 200x450 cm. 3,5 cm. thick



PROTEZIONI MURARIE E PER COLONNE - Wall protections



**PREVENTIVO SU RICHIESTA
PRICES ON REQUEST**



Art. B2085 / B2066

**Protezioni murarie e per colonna in vari spessori
sagomate su misura in EVA oppure in PE ad alta densità rivestito in PVC
fissaggio tramite occhiellature perimetrali, velcro oppure colla - per interno ed esterno
Customized wall and column protections various thickness for indoor and outdoor**

pg.45



Art. A10100 / A10150 / A10200
**Protezioni paraspigolo in PVC espanso
coestruso non ignifugo spessore cm. 1
larghezza cm. 5+5 in vari colori
lunghezza cm. 100-150-200**
PVC Edge Protections 1 cm. thick
width 5+5 cm.
length 100-150-200 cm.

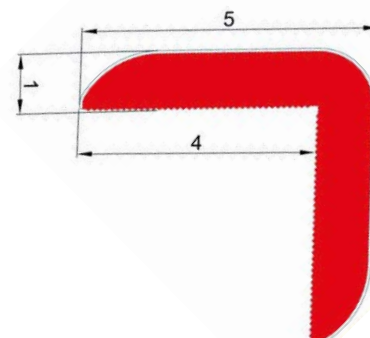

**Si applicano rapidamente
mediante normale silicone**
They are installed quickly by
means of standard silicone

TATAMI

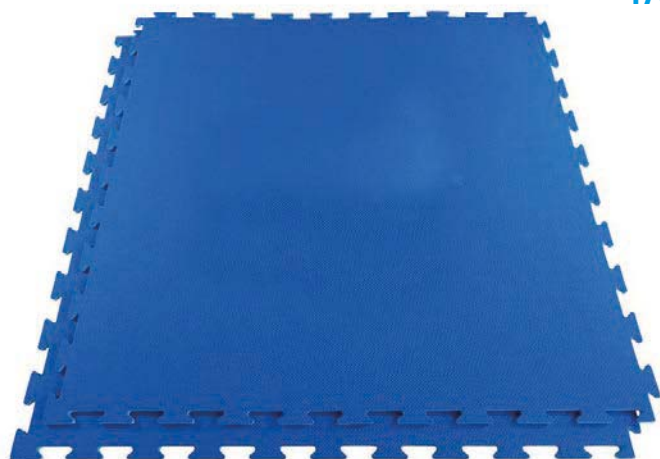

Art. R10X

TATAMI ad incastro in EVA cm.100x100x1
colore blu con 4 bordi
superficie lavabile, antiscivolo
EVA Tatami soft flooring 100x100x1 cm.

pg.53

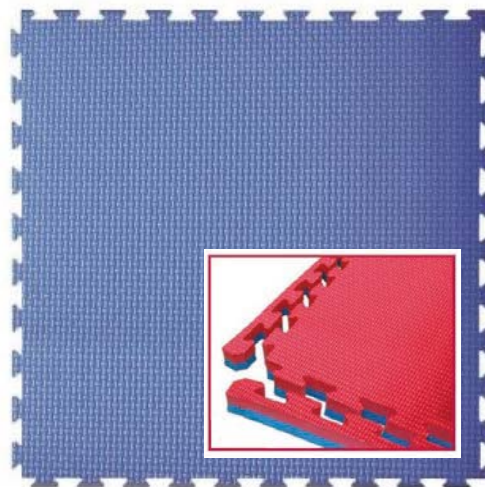

Art. MAT02 / MAT04

TATAMI ad incastro cm.100x100x2
o cm.100x100x4 rosso/blu con 4 bordi
superficie lavabile, antiscivolo, antifunghi,
antibatterica, anallergica, certificato EN71
Tatami soft flooring 100x100x2 cm./100x100x4 cm.

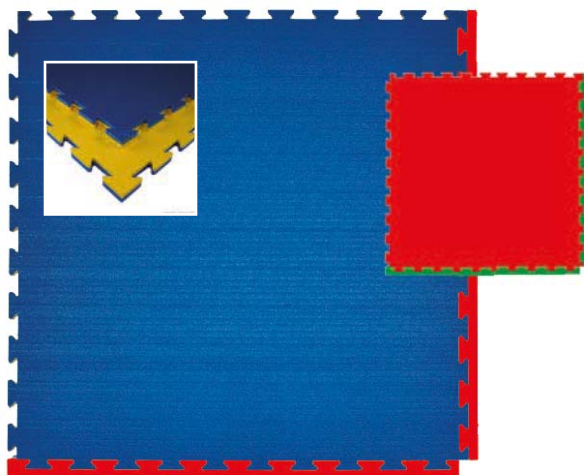

Art. TX-K20

TATAMI Karate K20
cm. 100x100x2 ad incastro, reversibile
in polietilene espanso reticolato
incluso bordo protettivo perimetrale
colori: verde/rosso, rosso/blu, giallo/blu
(ordine minimo 8 pezzi)
TATAMI K20 100x100x2 cm.
reversible, perimetric frame included
colors: red/green, red/blue, yellow/blue
(minimum order 8 pieces)

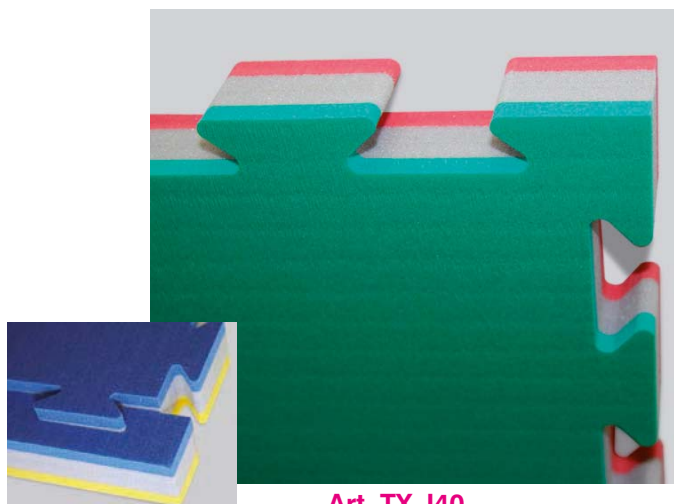

Art. TX-J40

TATAMI Judo J40
cm. 100x100x4 ad incastro, reversibile
in polietilene espanso reticolato
incluso bordo protettivo perimetrale
colori: verde/bianco/rosso, giallo/bianco/blu
(ordine minimo 4 pezzi)
TATAMI J40 100x100x4 cm. reversible,
perimetric frame included
colors: red/white/green, yellow/white/blue
(minimum order 4 pieces)



Art. TX-2010

TATAMI tradizionale
cm. 200x100x4 in PU
densità 230 Kg/mc
rivestito in PVC
con fondo antiscivolo
colori: blu, verde, rosso, giallo
(ordine minimo 4 pezzi)
TATAMI 200x100x4 cm.
in PU density 230 Kg/mc
cover with anti-skid PVC stratum
colors: blue, green, red, yellow
(minimum order 4 pieces)

GINNASTICA - Gymnastic



Art. S00352

**Armadio porta attrezzi
a 4 ripiani in lamiera
con vano portavalori
dimensioni cm. 100x45x200h**

Equipment locker with safe-deposit box



Art. S00354

**Armadio porta attrezzi a 4 ripiani
in lamiera dimensioni cm. 100x45x200h**
Equipment locker



Art. S00356

**Armadio porta attrezzi
in lamiera dimensioni
cm. 120x45x200h
a 4 ripiani
e porte scorrevoli**
Equipment locker with
sliding doors

● pg.47

Art. S00362

Mobile porta attrezzi su ruote
Equipment trolley on wheels



● pg.23

Art. F406
**Armadio porta
attrezzi in acciaio
zincato a pareti
smontabili,
con ruote
dimensioni
cm. 156x76x163h**
Equipment locker in
galvanized steel
on wheels





Art. CAGL
Coppia anelli in legno di faggio
con cinghie nylon regolabili
Pair of wooden rings with adjustable nylon belts

pg.47

Art. S00002
Coppia anelli
in legno lamellare
Pair of wooden rings



Art. S00018
Confezione da 8 pani
magnesio gr. 55
Chalk blocks



pg.48



Art. E8000
Paio scarpette in pelle
per ginnastica ritmica
colore nero o bianco
taglie da 26 a 46
Pair of shoes for rhythmic gym
color black or white



Art.S00512
Mensola porta clavette
Club wall holder

Art. P00510/S00502/S00506
Coppia clavette in nylon,
in legno a collo lungo e collo corto
Wooden and plastic clubs



Art. CS5
Corda salto
per ritmica
m. 3
Jumping rope

pg.47



Art. P01210
Nastro per ginnastica
ritmica m. 6
Rhythmic
gym streamer



Art. CS7
Corda salto
per ritmica
m. 3 piombata
Weighted jumping
rope



Art. S01482
Tamburello
completo
di batacchio
Rhythmic
gym drum



pg.49

Art. S01624
Specchio quadrettato
con cornice
in legno da fissare a parete
misure cm.200x100
Wall mirror with wooden frame



Art. S01606
Supporto per sbarra regolabile da fissare a parete
 Support for bar to be fixed on the wall

pg.48

pg.49



Art. S01608
Supporto per sbarra regolabile da fissare a terra
 Support for bar to be fixed on the floor

Art. S01602
Sbarra per danza in legno (pezzo unico fino a 4 metri)
 Wooden bar



Art. 1156TE
Supporto per sbarra regolabile da cm. 78 a cm. 140 in acciaio con base autoportante economica
 Cheap freestanding support for bar



Art. S00304
Coppia ceppi Baumann in legno
 Pair of Baumann blocks in wood

pg.47



Art. S00302
Coppia appoggi Baumann in legno
 Pair of Baumann supports in wood



Art. S01052 / S01054 / S01060 / S01062
Scale ortopediche dritte o curve, a parete o trasportabili
 Orthopaedic ladders

pg.49



Art. S00772/S00774
Fune per salita
 lunghezza m. 5/m. 6
 Climbing Rope
 length 5 m./6 m.

pg.48



Art. S00754 / S00756
Palchi di salita
 (dettagli sul listino prezzi)
 Climbing apparatus

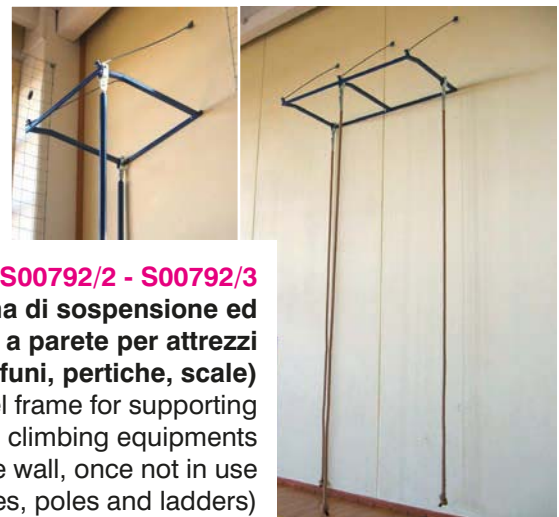

Art. S00792/2 - S00792/3
Sistema di sospensione ed accostamento a parete per attrezzi da arrampicata (funi, pertiche, scale)
 Varnished steel frame for supporting and sliding climbing equipments to the wall, once not in use (ropes, poles and ladders)



pg.47

Art. S00056 / S00058 / S00052 / S00054
Assi di equilibrio ad altezza fissa e graduabile
 Balance beams adjustable and fixed height

pg.49



Art. S00060 / S00064
Trave di equilibrio in alluminio rivestito lunghezza mt.5 ad altezza regolabile (a norme F.I.G.) oppure ad altezza fissa
 Balance beam 5 meters adjustable height 50-120 cm. or fixed height



pg.48



Art. S00204 / S00206 / S00208 / S00210
Pedane elastiche con piano di battuta in legno, ricoperto in gomma, ricoperto in moquette o a doppio molleggio
 Springboards



Art. S00104
Cavallo regolamentare per volteggio rivestito in pelle sintetica altezza regolabile
 Vaulting buck adjustable height

pg.48



Art. V1168
Cavallina regolamentare rivestita in similpelle altezza regolabile da cm. 90 a cm.130
 Vaulting buck adjustable height



pg.48

Art. S00218 / S00220
Tappeto arrotolabile per pedana corpo libero in poliuretano e moquette, rotolo da m. 15/25 larghezza cm. 100/200
 Gymnastic moquette floor, roll m.15/25 long 100/200 cm. wide



pg.13

Art. S00914/S00918/S00920
Panche svedesi
 Swedish benches



Art. S00252
**Sbarra orizzontale
per volteggi regolabile in
altezza, fissaggio
a terra con tiranti**
Vaulting bar adjustable height



Art. S00160
**Parallela Scolastica a losanga
ad altezza fissa, staggi in legno lamellare**
Scholastic parallels fixed height

pg.48



Art. S00156
**Parallela Asimmetrica Femminile in acciaio verniciato
su basamento pesante, montanti graduabili,
staggi in legno lamellare regolabili in altezza e larghezza**
Asymmetrical bars adjustable height



Art.S00152
**Parallela Maschile in acciaio verniciato
su basamento pesante, montanti graduabili,
staggi in legno lamellare
regolabili in altezza e larghezza**
Parallels bars adjustable height

ATLETICA - Track & Field



Art. PBS-SI

Blocco di partenza da allenamento
Polanik in acciaio zincato
 Starting Blocks Polanik in galvanized steel



Art. BL01

Paio Blocchi di partenza in gomma per palestra
 Pair of gym Starting Blocks in rubber for beginners



Art. S02010/PPA38

Testimoni per staffetta
 in PVC o omologati in alluminio
 PVC or aluminium relay baton



pg.49

Art. TYVS
Pettorali in tyvek
 per gare atletica
 cm.21x16h
 personalizzabili
 Numbers for competitions



Art. S02112

Megafono a transistor portatile
 Handy megaphone

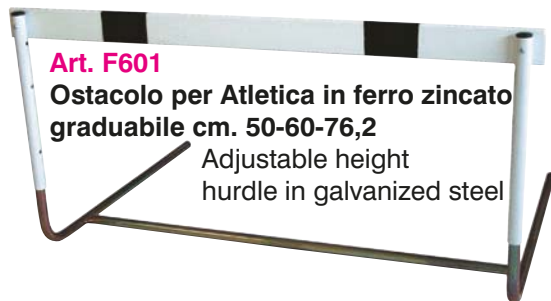

Art. F601

Ostacolo per Atletica in ferro zincato
 graduabile cm. 50-60-76,2
 Adjustable height
 hurdle in galvanized steel



Art. S02126

Pistola a tamburo
 per starter
 Starter's revolver gun



Art. F602

Ostacolo per Atletica in ferro zincato
 graduabile cm. 76,2-84-91,4
 Adjustable height
 hurdle in galvanized
 steel

Art. S02072
Ostacolo per Atletica in
alluminio anodizzato
 graduabile
 cm. 76,2-84-91,4-100-106,7
omologato I.A.A.F.
 Adjustable height hurdle
 in anodized aluminium
 according to I.A.A.F. standards



Art. S02064

Ostacolo per Atletica
in acciaio graduabile
 cm. 76,2-84-91,4-100-106,7
 Adjustable height hurdle
 in steel



Art. VSH-222

Ostacolo per Atletica
Vinex olimpionico
in ferro zincato
omologato I.A.A.F.
 Adjustable height
 hurdle in galvanized
 steel according to
 I.A.A.F. standards



Art. S02552
Coppia ritti salto in alto scolastici altezza cm.200
Scholastic High Jump height 200 cm.



Art. S02554
Coppia ritti salto in alto scolastici in acciaio zincato altezza cm.230
Scholastic High Jump height 230 cm.



Art. S02556
Coppia ritti salto in alto in acciaio zincato periscopici h. cm.250
High Jump height 250 cm.



Art. S02558
Coppia ritti salto in alto in acciaio zincato periscopici da competizione h. cm.260
Competition High Jump height 260 cm.

(pg.52)



Art. S02584
Piattaforma zincata di sostegno e sollevamento zona di caduta
Galvanized steel support platform for landing mats

Art. B2080/B2081
Zone di caduta salto in alto
High Jump landing mats



Art. S02566
Asta segnalimite per salto in alto in PTE
High Jump crossbar with soft PTE cylinders

(pg.52)



Art. PVS-CPTA
Coppia ritti per salto con l'asta in alluminio graduabili fino a cm. 650
Pair of aluminium pole vault stands

Art. B2077/B2078
Zone di caduta salto con l'asta
Pole vault landing mats



Art. S02570
Asticella segnalimite per salto in alto m. 4 in vetroresina
High Jump fiberglass crossbar



Art. TT09/ ... /VT15
Palle lancio
in gomma Trial
varie grammature
 Trial rubber throwing balls



Art. VDL5/ ... /VDL72
Palle getto anelastiche
in gomma Trial
per indoor
varie grammature
 Trial rubber shot balls
 for indoor



Art. S02486/ ... /S02496
Palle getto in metallo verniciato
tarate, varie grammature
 Metal shot balls



Art. S02510
Pedana per lancio del peso
in acciaio zincato
 Galvanized steel shot put throwing circle

pg.50

pg.51



Art. S02512
FermapiEDE getto del peso
in legno massiccio
 Shot put toe board in wood

Art. STB-F100
FermapiEDE getto del peso
in vetroresina I.A.A.F.
 Shot put toe board in fiberglass I.A.A.F.



Art. CT6
Chiodo per scarpa
in acciaio mm.6 modello
Albero di Natale
per corsa campestre
 Shoe steel stud 6 mm.

pg.49



Art. P15020
Pedana Lancio in neoprene espanso
per allenamento lancio del disco,
peso, martello e salto in lungo
 Training toe board

pg.51



Art. P6 / P9
Chiodo per scarpa in acciaio
mm.6 o mm.9 modello Pyramid
 Shoe steel stud 6 or 9 mm.



Art. LM0.5/ ... /LM5
Martelli sicuri supersoft
in gomma Trial
varie grammature
 Supersoft Trial hammers

pg.51



Art. PM2/ ... /PM10
Martelli in acciaio da allenamento Polanik
 Polanik steel hammers



Art. DSK1/ ... /DSK2
Dischi in gomma Trial varie grammature
 Discus in rubber Trial



Dischi Jet speciali per avviamento al lancio con peso distribuito sulla parte esterna per favorire la penetrazione nell'aria
 Special Jet discus with weight distributed mainly on the external perimeter in order to increase air penetration

Art. JET03 / JET05 / JET1
Dischi Jet in gomma Trial
 Kg. 0,3/0,5/1
 Jet discus in rubber Trial

pg.49

pg.50



Art. DT0.4/ ... /DT1
Dischi Trial a 3 impugnature in gomma approvati I.A.A.F. per attività scolastica
 Trial discus approved by I.A.A.F. for school training

Art. W4T/ ... /W10T
Giavellotti Polanik in lega leggera con puntale in acciaio varie grammature
 Polanik Javelins in light alloy with steel edge in various weights



Art. TPD075/ ... /TPD3
Dischi in plastica bordati in acciaio Polanik
 Polanik discus in plastic-steel

Art. CPD1/ ... /CPD2
Dischi in plastica bordati in acciaio Polanik - omologati I.A.A.F.
 I.A.A.F. Polanik discus in plastic-steel



Art. TRTJ
Turbo Jav per avviamento al lancio
 Turbo Jav for throwing introduction

Art. P15262
Junior Jav in polietilene espanso
 cm. 88 gr. 50
 Junior Jav

Art. JAL-C400/ ... / JAL-C800
Giavellotti Vinex in lega leggera con puntale in acciaio varie grammature
 Vinex Javelins in light alloy with steel edge in various weights



Art. VMH
Vortex per avviamento al lancio del giavellotto e per football americano
 Vortex for throwing introduction

pg.50



Art. VMH.J
Mini Vortex gr. 40 lunghezza cm. 17
 Mini Vortex

PILATES



Art. EVA.P

Mattoncino pilates in eva
cm.22,5x14,5x7,5h
Block for pilates

pg.54



Art. MPS30

Mattoncino pilates gonfiabile
Trial soft gr. 300 cm.12x24x3,5h
Inflatable block for pilates

Art. MPS50

Mattoncino pilates gonfiabile
Trial soft gr. 500 cm.11,3x24x5,5h
Inflatable block for pilates



Art. AHF-065/AHF-066

Sfera tonificante
verde kg.1 / viola kg.1,5
Toning balls

Art. AHF-045

Palla per yoga
ø cm.25
Yoga ball



Art. BA4

Palla tender per pilates
ø cm.20 - gr. 180
super soffice e sicura
Trial rubber tender ball
for pilates



Art. TR38
Toning ring
Toning ring

pg.54



Art. AHF-001

Coppia sfere per massaggi
verde ø cm.7,5
viola ø cm.9
Massage balls



Art. AHF-020
Power grip ball
Power grip ball



pg.20



Art. FY9512

Fitball roller
gonfiabile
diametro cm.18
Fitball roller inflatable

Art. B55 / B75
Relax Ball Trial
ø cm.5,5 / 7,5
Relax Ball

Art. 995025

Cilindro pieno
Foam roll
lunghezza cm. 90
ø cm.15
Foam roll not
inflatable



pg.54



Art. 995025BIS
Mezzo cilindro pieno
Foam roll
lunghezza cm. 90
altezza cm.7,5
Half Foam roll
not inflatable



Art. AHF-044
Rullo massaggio
lunghezza cm.33
ø cm.14
Massaging roll



Art. AHF-111
Rullo massaggio con impugnature
cm.53 ø cm.4,5
Massaging roll

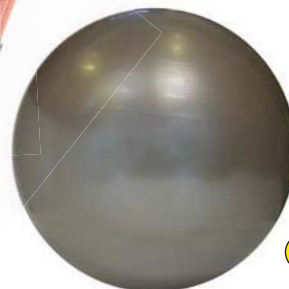

pg.22



Art. TBSA/TBSB

Palla Boa autobilanciante in gomma Trial
oscilla ma torna al suo posto senza rotolare,
stabile, ideale per correggere la postura,
monocolore per adulti/bicolore per bambini
Trial rubber Boa Ball swings but comes back
to its original position - very good for postural
therapy for adults and children

PALLAPUGNO - BOCCE - TAMBURELLI



Art. BA1

Air Ball Trial Ø cm. 12 gr. 100 morbida e rimbalzante (ideale anche per pallapugno)
Trial Air Ball



Art. M05010

Pallapugno FIPAP diametro cm. 14
FIPAP pallapugno



Art. GB100.03

Set 2 palette Front and Back con 2 palline
Front and Back set



pg.54

Art. ST14

Palla Canguro Ø cm. 45
Trial Cangaroo Ball



Art. ST15

Palla Canguro Ø cm. 55
Trial Cangaroo Ball



Art. ST16

Palla Canguro Ø cm. 65
Trial Cangaroo Ball



Art. ASKB

Set 8 bocce in legno laccato diametro mm. 100 con pallino diametro mm. 40
Set 8 wooden bowls

pg.54

Art. BTST12
Set 6+6 bocce supersoft con pallino e borsa
Set of 12 supersoft bowls with bag



Art. P18110
Tamburello indoor diametro cm. 26 (fino a 13 anni) omologato FIPT
FIPT indoor tamburello Ø cm. 26



Art. P18111

Tamburello indoor diametro cm. 28 omologato FIPT
FIPT indoor tamburello Ø cm. 28



Art. P18112

Pallina per tamburello depressurizzata indoor diametro cm. 6,5 gr. 40
Tamburello indoor depressurized ball



Art. S00552 / S00556
Fune per tiro alla fune lunghezza m. 15 / m. 25 con indicazioni colorate
Rope for tug of war length 15 / 25 meters

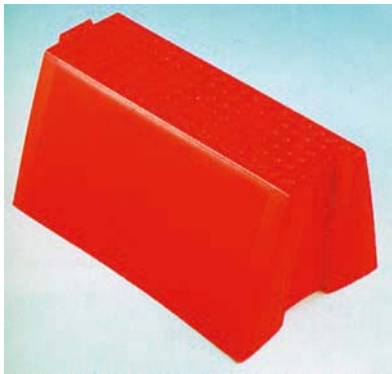

Art. I-059
Set 10 mattoncini dritti
cm. 25x16x13h
Set of 10 straight bricks

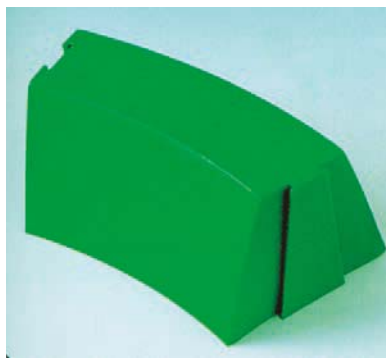

Art. I-060
Set 10 mattoncini curvi
cm. 22x16x13h
Set of 10 curved bricks

pg.54

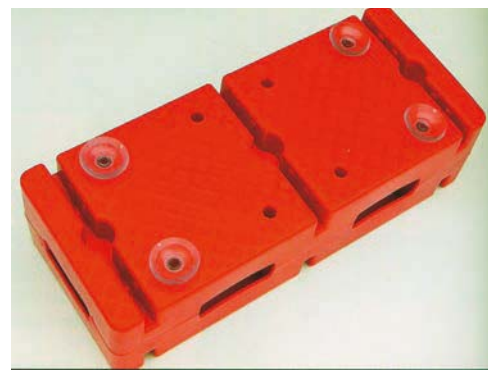

Art. I-098
Blocco percorso
cm. 30x15x10h
Block for route



Art. PCAD
Paracadute Ø cm. 300
Parachute



Art. I-061
Percorso equilibrio composto da
5 assi + 6 mattoncini + 24 ventose
Balance route



Art. S00794 pg.48
Pannello per arrampicata in legno
agganciabile a spalliera o quadro
svedese
Climbing board



Art. DDB12
Bussola per
orienteeing
in plastica
trasparente
con laccio
Compass

pg.54



**PALLA
AVVELENATA
Dodgeball**



Art. TDB16
Palla per Dodgeball diametro cm. 16
peso gr. 210 colore arancio fluo
Dodgeball Ø cm. 16

pg.54



Art. TDB20
Palla per Dodgeball diametro cm. 20
peso gr. 230 colore giallo fluo
Dodgeball Ø cm. 20

SKATEBOARD - PATTINI - MONOPATTINI - FRISBEE



Art. SKM2401 Skateboard Junior cm.61



Art. SKM3103 Skateboard Senior cm.77,5



Art. F4-400
Casco Skate
taglie S, M, L
Skate helmet

pg.53

New!



Art. GDA20
Bersaglio elettronico
per il gioco delle
freccette (incluse 6
freccette e 40 punte di
ricambio)
Darts electronic target
(including 6 darts and 40
spare tips)



Art. 681171
Set 3 protezioni Junior

Art. 132171
Set 3 protezioni Senior
(misura S, M, L)
Junior and Senior protections



Art. SKJP-G
Pattino in line
allungabile Junior
taglie: 30/33 - 34/37 - 38/41
In line skate adjustable size



Art. ML9200
Monopattino
pieghevole,
ruote Ø mm. 200
peso massimo
utilizzatore kg. 100
Scooter

Art. ML8125
Monopattino
pieghevole,
ruote Ø mm. 125
peso massimo
utilizzatore kg. 50
Junior Scooter

New!



Art. AHF-084
Bastoncini
Nordic
Walking
con altezza
regolabile da
65 a 135 cm.
(3 tipi di punte
incluse)
Nordic Walking
sticks with adjustable
height from
65 to 135 cm.
(3 types of tips included)



Art. FRPPR
Frisbee
diametro
cm. 27,5
gr.160
Frisbee

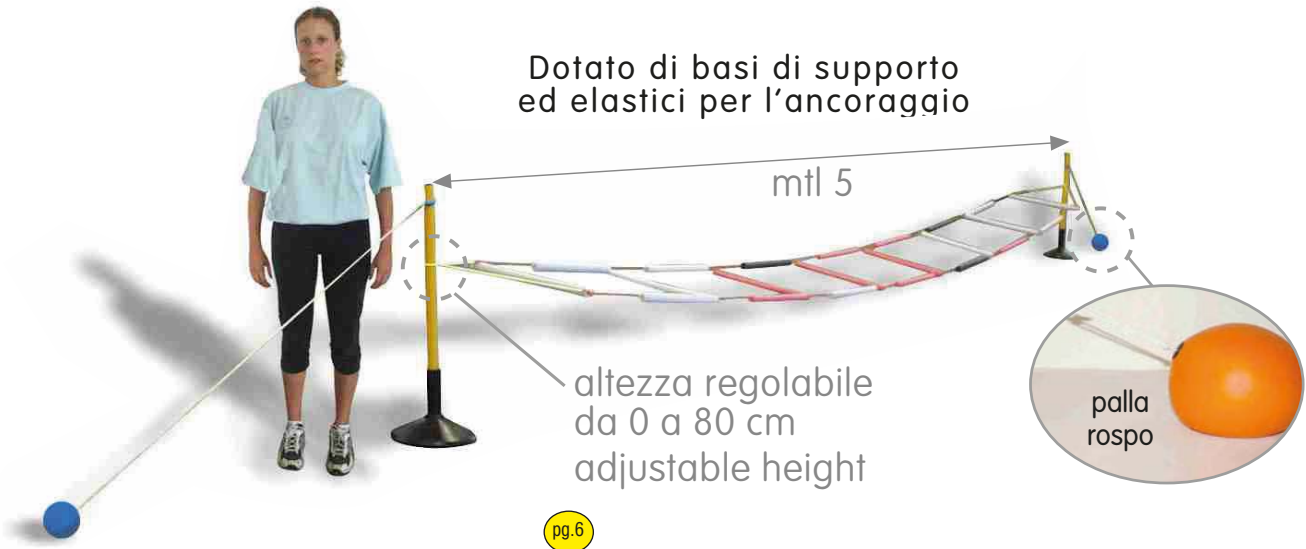

Art. T10076
Coordinatore di Frequenza / Calcio Tennis
lunghezza m. 5 utilizzabile anche su superfici sintetiche
attrezzo sicuro, privo di picchetti in metallo
 Speed Ladder / Soccer Tennis Kit
 length 5 meters - also for indoor or artificial grass
 safe without any metal spikes

Ideale per i bambini delle scuole calcio
best for soccer school kids



INDICE - INDEX

Attrezzature per la preparazione atletica e specifiche per il Calcio
Training and Soccer equipment

| | | |
|--|------|------------|
| Sagome e Barriere - Mannequins and Barriers | pag. | 6-17 |
| Barriera filtrante, Barriera con finestre - Reflex Training Device, Window Barrier | pag. | 42 |
| Paletti Slalom - Slalom Poles | pag. | 18-20 |
| Delimitatori e Birilli - Markers and Cones | pag. | 21-25 |
| Ostacoli ad altezza fissa e regolabile - Hurdles fixed and adjustable heights | pag. | 26-35 |
| Kit Calcio Tennis - Soccer Tennis kits | pag. | 36-38 |
| Forche - Heading Trellises | pag. | 40-41 |
| Archi di precisione - Precision Arcs | pag. | 39 |
| Muri e Telai con rete - Rebounders and Iron Frames with net | pag. | 43-51 |
| Deviatori di traiettoria, Ball Playning - Deviators, Ball Playning | pag. | 52-54 |
| Cross Training, Reti con bersagli - Cross Training, Nets with targets | pag. | 141-142 |
| Strutture instabili e Tavole Propriocettive, Plinti - Equilibrium Boards | pag. | 55-61 |
| Trampolini - Trampolines | pag. | 62 |
| Attrezzi speciali, Scalette e Bande elastiche - Special Training tools, Speed Ladders and Elastic Bands | pag. | 63-79 |
| Kit tecnico Scuola Calcio - Soccer School kit | pag. | 80 |
| Fitness Equipment | pag. | 81-88 |
| Casacche, Pantaloncini, Calze, Giacche Antipioggia, Tubolare Barret, Numeri Termosaldabili - Mesh Shirts, Shorts, Socks, Rain jackets, Tubular hat, Numbers for uniforms | pag. | 89-91;98 |
| Tacchetti ed accessori per scarpe, Lavascarpe - Studs and shoe accessories, Shoe Washing Device | pag. | 92-95 |
| Parastinchi, Fasce Capitano, Guanti Portiere - Shinguards, Captain Armbands, GK Gloves | pag. | 96-97 |
| Lavagne Tattiche - Tactical Boards | pag. | 100-103 |
| Ghiaccio, Tape, Creme, Oli - Ice, Tape, Creams, Oils | pag. | 104-105 |
| Materassini, Borracce - Mats, Water Bottles | pag. | 99;106-107 |
| Bandierine e accessori per arbitro - Flags and referee's accessories | pag. | 108-111 |
| Pompe, Compressore, Cronometri e Rotelle Metriche - Pumps, Inflator, Chronometers, Measuring Tapes | pag. | 114-115 |
| Segnalatori manuali ed elettronici per cambio giocatori - Substitution Boards | pag. | 112-113 |
| Palloni in pelle ed in gomma - Leather and rubber Balls | pag. | 116-119 |
| Palle Mediche, Ritmiche e Psicomotorie - Medicine, Rhythmic and Gym Balls | pag. | 120-123 |
| Ceste Portapalloni - Baskets for balls | pag. | 126 |
| Borse - Bags | pag. | 124-125 |
| Protezioni personali - Protections | pag. | 182-183 |

Attrezzature per lo stadio e lo spogliatoio
Stadium and locker room equipment

| | | |
|--|------|---------|
| Porte regolamentari, ridotte, miniporte, porte bifrontali - Official goals, reduced goals, minigoals, 2 side goals . | pag. | 127-136 |
| Reti regolamentari e ridotte - Nets all sizes | pag. | 137-139 |
| Reti di Protezione - Protection Nets | pag. | 140 |
| Panchine Allenatori - Trainers' Dug-outs | pag. | 143-149 |
| Vernice Segnacampo, Carrelli Traccialinee - Ecological Paint, Line Markers | pag. | 150-152 |
| Sedute per gradinate e Tribune modulari per interno ed esterno - Stadium seats and Stands | pag. | 153-155 |
| Arredi spogliatoio ed infermeria - Locker and infirmary room | pag. | 156-161 |
| Tunnel uscita spogliatoi - Stadium Tunnels | pag. | 162 |
| Tabelloni elettronici segnapunti - Electronic scoreboards | pag. | 186-188 |
| Materassi, Protezioni Murarie - Mats, Wall Protections | pag. | 206-208 |

Altri sport - other sports

| | | |
|--|------|-----------------|
| Tavoli calcetto - Soccer tables | pag. | 164 |
| Basket | pag. | 165-172 |
| Volley | pag. | 173-178 |
| Minivolley, Superminivolley | pag. | 179 |
| Beach Volley | pag. | 180-181 |
| Beach Soccer | pag. | 163 |
| Impianti Multifunzione - Multi purpose systems | pag. | 184 |
| Pallamano - Handball | pag. | 185 |
| Tennis, Beach Tennis, Padel | pag. | 189-191 |
| Tennis Tavolo - Table Tennis | pag. | 192-194 |
| Badminton | pag. | 200 |
| Rugby | pag. | 195-196 |
| Piscina, Pallanuoto - Swimming Pool, Waterpolo | pag. | 197-199 |
| Hockey, Baseball | pag. | 201;204 |
| Arti Marziali, Boxe - Martial Arts, Boxing | pag. | 202-203;205;209 |
| Ginnastica - Gymnastic | pag. | 210-214 |
| Atletica - Track and Field | pag. | 215-218 |
| Pilates, Didattica Scolastica, Pattini e Skateboard - Pilates, School Products, Skates | pag. | 219-222 |

NEW VIDEOS ON
WWW.BARRETSport.COM



BARRET®

ATTREZZATURE PER L'ALLENAMENTO DEI CAMPIONI
TRAINING TOOLS FOR CHAMPIONS



BARRET SRL

Via Marie Curie, 6/8
Zona Ind.le S. Pietro in Palazzi
57023 Cecina (LI) - Italy
tel. (+39) 0586 661215
fax (+39) 0586 662417
info@barretsport.com
www.barretsport.com

