



# BARRET®

ATTREZZATURE PER L'ALLENAMENTO DEI CAMPIONI  
TRAINING TOOLS FOR CHAMPIONS



catalogo  
2017-2018  
brochure











**Real Zaragoza S.A.D.  
Ciudad Deportiva**



Real Zaragoza S.A.D.  
Ciudad Deportiva







## Barret Srl

Dal 1989 Barret Srl produce attrezzature tecniche per lo sport.

In particolare, l'Azienda si è affermata nel corso degli anni per la ideazione e realizzazione di strumenti di allenamento ormai divenuti indispensabili per la preparazione fisica, tecnica e tattica dei giocatori di Calcio, così come per la preparazione degli atleti di molti altri sport, sia di squadra che individuali.

Barret offre la più ampia varietà di attrezzature quali sagome, ostacoli, delimitatori, birilli, paletti per slalom, archi di precisione, kit per Calcio-Tennis, forche, bande elastiche, slitte, plinti, tavolette propriocettive, telai con rete, muri in vetroresina, miniporte, porte bifrontali, ridotte, regolamentari.

La qualità che distingue i prodotti offerti e le numerose innovazioni proposte con continuità nel corso degli anni hanno permesso all'Azienda di affermarsi non solo sul mercato italiano, ma anche su quello internazionale.

Barret ha sviluppato nel tempo una preziosa collaborazione con Milan ed Inter, fondamentale per permettere un interscambio di idee ed informazioni con i preparatori atletici della prima squadra e del settore giovanile, finalizzato al continuo miglioramento della funzionalità delle attrezzature tecniche per l'allenamento.

**I prodotti Barret, infatti, vengono utilizzati quotidianamente sui campi di allenamento del Centro di Vinovo, di Milanello e di Appiano Gentile per coadiuvare la preparazione fisica e tecnica di alcuni tra i migliori giocatori di Calcio del mondo.**

Sarebbe impresa ardua ricordare tutti i Club e le Nazionali che hanno scelto più volte di acquistare le nostre attrezzature per l'allenamento e per la gara attraverso la rete distributiva italiana ed estera.

Cogliamo l'occasione per ringraziare i preparatori atletici ed i responsabili acquisti di Arsenal, Barcellona, Bologna, Catania, Chelsea, Fiorentina, Inter, Juventus, Lazio, Milan, Lione, Liverpool, Manchester City, Manchester United, Monaco, Napoli, Palermo, Pescara, Reggina, Roma, Sampdoria, Udinese, Zenit e delle Nazionali di Calcio di Italia, Germania, Inghilterra e Irlanda.

### Company Profile

*Founded in 1989, Barret Srl produces all kinds of sport equipment and has established itself worldwide by devising and creating innovative tools which have become more and more important for improving tactical training and performances either of Soccer players or athletes practising other individual or team games.*

*Barret manufactures special products such as mannequins, hurdles, markers, cones, hoops, slalom poles, shooting arcs, Soccer-Tennis kits, heading trellises, elastic bands, sledges, vaulting boxes, equilibrium boards, iron frames with net, fiberglass rebounders, minigoals, reduced and regular goals.*

*The quality typical of tools and the variety of innovations introduced during the years have made Barret successful on both the Italian and the international market. Indeed, Barret develops its products also thanks to special partnerships with AC Milan and FC Internazionale Milano, two of the most prestigious Soccer Clubs in the world. The close relationship between Barret and their trainers has allowed a fruitful exchange of ideas and information, aimed at enhancing the functional capacity of technical equipment.*

*As a result, Barret tools are used every day at Vinovo, Milanello and Appiano Gentile camps to help athletic and technical training of some of the greatest Soccer players in the world.*

*It would be nearly impossible to name all professional Soccer Clubs and National Teams in Italy and Europe that have often chosen Barret equipment, purchasing training and competition tools through our distribution networks. We take this opportunity to thank Clubs such as Arsenal, Barcellona, Bologna, Catania, Chelsea, Fiorentina, Inter, Juventus, Lazio, Milan, Lione, Liverpool, Manchester City, Manchester United, Monaco, Napoli, Palermo, Pescara, Reggina, Roma, Sampdoria, Udinese, Zenit and the Italian, English, German and Irish National Teams.*

# BARRET®

Le materie prime (i vari preparati plastici ed i profilati in polipropilene copolimero ed in PVC nei vari diametri, spessori e colori) utilizzate da BARRET per lo stampaggio e l'assemblaggio degli articoli in materiale plastico sono certificate dai nostri fornitori nel rispetto delle normative vigenti che impediscono l'utilizzo di sostanze ritenute tossiche per la salute dell'uomo e dell'ambiente.

*Barret manufactures plastic products in PVC and polypropylene such as dummies, cones, markers, hurdles, slalom poles etc. using only certified non toxic raw materials not dangerous for human beings and the environment.*

## NUOVI PRODOTTI - NEW PRODUCTS



**Art. 007.25**  
**Paletto**  
 cm. 170  
 smontabile  
 in PVC  
 Ø 25 mm  
 con puntale  
 zincato svitabile  
 colore giallo  
 Dismountable  
 Pole 170 cm.  
 height in PVC  
 with removable  
 galvanized metal  
 spike  
 color yellow

Pag. 26



**Art. C4**  
**Rebound Disk - diametro cm.40**  
**altezza cm.4 - Kg.1,5 colore rosso**  
 40 cm. diameter - 4 cm. thick - 1,5 Kg.

Pag. 63



Pag. 75

**Art. AHF-128/AHF-129/AHF-130/  
 AHF-131/AHF-132**

**Elastico ad anello Power Band**  
 Ø mm. 2080x4,5 spessore  
 rosso h. mm. 13 - nero h. mm. 22  
 viola h. mm. 29 - verde h. mm. 45  
 blu h. mm. 64

Power Band elastic Ø mm.2080x4,5 thick  
 red 13 mm. height - black 22 mm. height  
 violet 29 mm. height - green 45 mm. height  
 blue 64 mm. height



Pag. 131

**Art. PUG**  
**Coppia Miniporte in nylon**  
**m. 1,83 x 1,07 complete di reti, picchetti e borsa**  
 Pair of nylon Mini-goals 1,83 x 1,07 m.  
 nets, pegs and bag included



**Art. F218**  
**Coppia Miniporte professionali**  
**in acciaio verniciato**  
**tubo sezione 80 mm.**  
**dimensioni cm. 90x60**  
**complete di reti**  
 Pair of professional steel Mini-goals  
 pipe 80 mm.  
 dimensions 90x60 cm.  
 nets included

Pag. 130



Pag. 65

**Art. SH40**

Innovativa **STRUTTURA AUTOPORTANTE** di 4 metri di lunghezza per l'allenamento dell'equilibrio, che permette di fissare la fettuccia a due altezze: cm. 30 oppure cm. 50. Perfetta per palestre, scuole ed uso domestico. **Fettuccia inclusa.**

New slackline structure for balance training, 4 meter long, 2 possible heights to select: 30 or 50 cm. Best for gyms, schools or just at home. Slackline included.



Pag. 112

**Art. NKPA4/NKPA5**

**Pallone calcio Nike Pitch Team** colore bianco o arancio n. 4 e n. 5  
Nike training ball size 4 and 5



Pag. 113

**Art. GPC8**

**Pallone calcio a 8 Gems Raptor C8**  
in PU n. 4,5  
Ball Gems in PU size 4,5



Pag. 116

**Art. AHF-105 / AHF-106 / AHF-107 AHF-108 / AHF-109**

**Palle Mediche**  
rigonfiabili e rimbalzanti  
Kg. 1 - 2 - 3 - 4 - 5  
ad alto grip colore nero

Medicine Balls inflatable and rebounding  
high grip in black color



Pag. 116

**Art. AHF-048/.../AHF-097**

**Slam ball** kg. 2 - 3 - 4 - 5 -  
6 - 7 - 8 - 9 - 10 - 12 - 15



**Art. AHF-117/.../AHF-125**

**Wall ball**  
kg. 3 - 4 - 5 - 6 - 7 - 8 - 9 - 10 - 12



**Scegliere reti con profondità  
posteriore bassa cm. 160**  
Pick nets with depth 160 cm. at ground level

**Art. 119G Coppia Porte m. 5 x 2 a traversa divisa  
in acciaio trasportabili tubo 80 mm.**

Pair of Goals m. 5 x 2 crossbar in 2 pieces in painted steel,  
transportable, pipe 80 mm.

**Art. 120-G Coppia Porte m. 6 x 2 a traversa divisa  
in acciaio trasportabili tubo sezione 80 mm.**

Pair of Goals m. 6 x 2 crossbars in 2 pieces  
in painted steel, transportable pipe 80 mm.

Pag. 127

## INDICE - INDEX

### Attrezzature per la preparazione atletica e specifiche per il Calcio Training and Soccer equipment

Sagome - Mannequins.....	pag. 12-23
Barriera filtrante, Barriera con finestre - Reflex Training Device, Window Barrier.....	pag. 24
Paletti - Slalom Poles.....	pag. 25-27
Delimitatori e Birilli - Markers and Cones.....	pag. 28-32
Ostacoli ad altezza fissa e regolabile - Hurdles fixed and adjustable heights.....	pag. 33-42
Kit Calcio Tennis - Soccer Tennis kits.....	pag. 43-46
Forche - Heading Trellises.....	pag. 48-49
Archi di precisione - Precision Arcs.....	pag. 47
Muri e Telai con rete - Rebounders and Iron Frames with net.....	pag. 50-57
Deviatore di traiettoria, Ball Playning - Deviator, Ball Playning.....	pag. 58
Cross Training, Rete con bersagli - Cross Training, Net with 5 targets.....	pag. 59
Strutture instabili e Tavole Propriocettive, Plinti - Equilibrium Boards.....	pag. 60-66
Trampolini, Cerchi, Corde, Bastoni - Trampolines, Hoops, Jumping Cords, Sticks.....	pag. 67;70
Attrezzi speciali, Scalette e Bande elastiche - Special Training tools, Speed Ladders and Elastic Bands.....	pag. 68-69;71-78
Kit tecnico Scuola Calcio - Soccer School kit.....	pag. 79
Fitness Equipment.....	pag. 80-87
Casacche, Pantaloncini, Calze, Giacche pioggia, Tubolare Barret, Numeri Termosaldabili, Parastinchi, Fasce Capitano, Guanti Portiere - Mesh Shirts, Shorts, Socks, Rain jackets, Tubular hat, Numbers for uniforms, Shinguards, Captain Armbands, GK Gloves.....	pag. 88-93
Tacchetti ed accessori per scarpe, Lavascarpe - Studs and shoe accessories, Shoe Washing Device.....	pag. 94-96
Lavagne Tattiche - Tactical Boards.....	pag. 98-100
Ghiaccio, Tape, Creme, Oli - Ice, Tape, Creams, Oils.....	pag. 102-103
Materassini, Borracce - Mats, Water Bottles.....	pag. 97;101
Bandierine e accessori per arbitro - Flags and referee's accessories.....	pag. 104-107
Pompe, Compressori, Cronometri e Rotelle Metriche - Pumps, Inflators, Chronos.....	pag. 108-109
Segnalatori elettronici e manuali per cambio giocatori, Segnapunti - Substitution Boards.....	pag. 110-111
Palloni in pelle ed in gomma - Leather and rubber Balls.....	pag. 112-115
Palle Mediche, Ritmiche e Psicomotorie - Medicine, Rhythmic and Gym Balls.....	pag. 116-119
Ceste Portapalloni - Baskets for balls.....	pag. 122
Borse - Bags.....	pag. 120-121
Protezioni personali - Protections.....	pag. 174-175

### Attrezzature per lo stadio e lo spogliatoio Stadium and locker room equipment

Porte regolamentari, ridotte, miniporte, porte bifrontali - Official goals, reduced goals, minigoals, 2 side goals.....	pag. 123-131
Reti regolamentari e ridotte - Nets all sizes.....	pag. 132-133
Reti di Protezione - Protection Nets.....	pag. 134
Panchine Allenatori - Trainers' Dug-outs.....	pag. 135-141
Carrelli Traccialinee, Vernice segnacampo - Line Markers, Ecological Paint.....	pag. 142-144
Scocche per tribune e Tribune modulari per interno ed esterno - Stadium seats and Stands.....	pag. 145-147
Arredi spogliatoio ed infermeria - Locker and infirmary room.....	pag. 148-153
Tunnel uscita spogliatoi - Stadium Tunnels.....	pag. 154
Tabelloni elettronici segnapunti - Electronic scoreboards.....	pag. 177-179
Materassi, Protezioni Murarie - Mats, Wall Protections.....	pag. 196-198

### Altri sport - other sports

Tavoli calcetto - Soccer tables.....	pag. 156
Basket.....	pag. 157-163
Volley.....	pag. 164-169
Minivolley.....	pag. 170
Beach Volley.....	pag. 172-173
Beach Soccer.....	pag. 155
Impianti Multifunzione - Multi purpose systems.....	pag. 171
Pallamano - Handball.....	pag. 176
Tennis, Beach Tennis.....	pag. 180-182
Tennis Tavolo - Table Tennis.....	pag. 183-185
Badminton.....	pag. 186
Rugby.....	pag. 187
Piscina, Pallanuoto - Swimming Pool, Waterpolo.....	pag. 188-190
Hockey, Baseball.....	pag. 191-192
Arti Marziali, Boxe - Martial Arts, Boxing.....	pag. 193-195;199
Ginnastica - Gymnastic.....	pag. 200-204
Atletica - Track and Field.....	pag. 205-208
Pilates, Didattica Scolastica, Pattini e Skateboard - Pilates, School Products, Skates.....	pag. 209-212

## INDICE ALFABETICO

Archi di precisione.....	pag. 47
Arredi spogliatoio e infermeria.....	pag. 148-153
Aletica.....	pag. 205-208
Badminton.....	pag. 186
Bande elastiche.....	pag. 75-78
Bandierine e accessori per arbitro.....	pag. 104-107
Barriere filtranti.....	pag. 24
Baseball.....	pag. 192
Basket.....	pag. 157-163
Beach Soccer.....	pag. 155
Beach Volley.....	pag. 172-173
Birilli.....	pag. 30-32
Borracce.....	pag. 101
Borse.....	pag. 120-121
Boxe, Arti Marziali.....	pag. 193-195
Calze.....	pag. 89
Carrelli Traccialinee.....	pag. 142-143
Casacche.....	pag. 88
Cerchi, Corde, Bastoni.....	pag. 70
Ceste Portapalloni.....	pag. 122
Delimitatori.....	pag. 28-29
Deviatore di traiettoria, Ball Playning.....	pag. 58
Fasce Capitano.....	pag. 93
Fitness Equipment.....	pag. 80-87
Forche.....	pag. 48-49
Ghiaccio, Tape, Creme, Oli.....	pag. 102-103
Ginnastica.....	pag. 200-204
Guanti Portiere.....	pag. 93
Hockey.....	pag. 191
Impianti Multifunzione.....	pag. 171
Kit Calcio Tennis.....	pag. 43-46
Kit tecnico Scuola Calcio.....	pag. 79
Lavagne Tattiche.....	pag. 98-100
Materassi.....	pag. 196-197
Materassini.....	pag. 97
Minivolley.....	pag. 170
Muri e Telai con rete.....	pag. 50-57;59
Numeri Termosaldabili.....	pag. 91
Ostacoli ad altezza fissa e regolabile.....	pag. 33-42
Paletti.....	pag. 25-27
Pallamano.....	pag. 176
Palle Mediche, Ritmiche e Psicomotorie.....	pag. 116-119
Palloni in pelle ed in gomma.....	pag. 112-115
Panchine Allenatori.....	pag. 135-141
Pantaloncini.....	pag. 89
Parastinchi.....	pag. 92
Pilates, Didattica Scolastica, Pattini e Skateboard.....	pag. 209-212
Piscina, Pallanuoto.....	pag. 188-190
Pompe, Compressori, Cronometri e Rotelle Metriche.....	pag. 108-109
Porte regolamentari, ridotte, miniporte, porte bifrontali.....	pag. 123-131
Protezioni Murarie.....	pag. 198
Protezioni Personali.....	pag. 174-175
Reti di Protezione.....	pag. 134
Reti regolamentari e ridotte.....	pag. 132-133
Rugby.....	pag. 187
Sagome.....	pag. 12-23
Scalette e attrezzi speciali.....	pag. 68-69;71-74
Scocche per tribune e Tribune modulari per interno ed esterno.....	pag. 145-147
Segnalatori elettronici e manuali per cambio giocatori, Segnapunti.....	pag. 110-111
Strutture instabili e Tavolette Propriocettive, Plinti.....	pag. 60-66
Tabelloni elettronici segnapunti.....	pag. 177-179
Tacchetti e accessori per scarpette, Lavascarpe.....	pag. 94-96
Tavoli calcetto.....	pag. 156
Tennis Tavolo.....	pag. 183-185
Tennis, Beach Tennis.....	pag. 180-182
Trampolini.....	pag. 67
Tunnel uscita spogliatoi.....	pag. 154
Vernice segnacampo.....	pag. 144
Volley.....	pag. 164-169



pg.1

**NUOVO MATERIALE PIU' FLESSIBILE!!!  
NEW MORE ELASTIC PLASTIC MATERIAL!!!**



**Art. 001**  
**Sagoma Barret brevettata**  
**cm. 180 Kg. 3,5**  
Patented Barret Mannequin  
cm. 180 Kg. 3,5

**Art. 002**  
**Sagoma Barret brevettata**  
**cm. 160 Kg. 3**  
Patented Barret Mannequin  
cm. 160 Kg. 3

Colori:  
Rosso, Blu e Giallo  
Colors:  
Red, Blue and Yellow

**SAGOME BARRET BREVETTATE**  
leggere, flessibili, super-resistenti,  
antifortunistiche!  
**PATENTED BARRET MANNEQUINS**  
light, flexible, strong, safe!

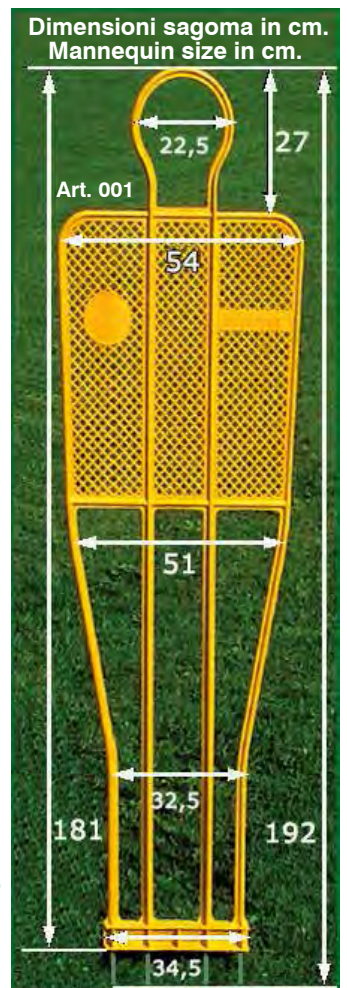

## SAGOME E BARRIERE - Barriers

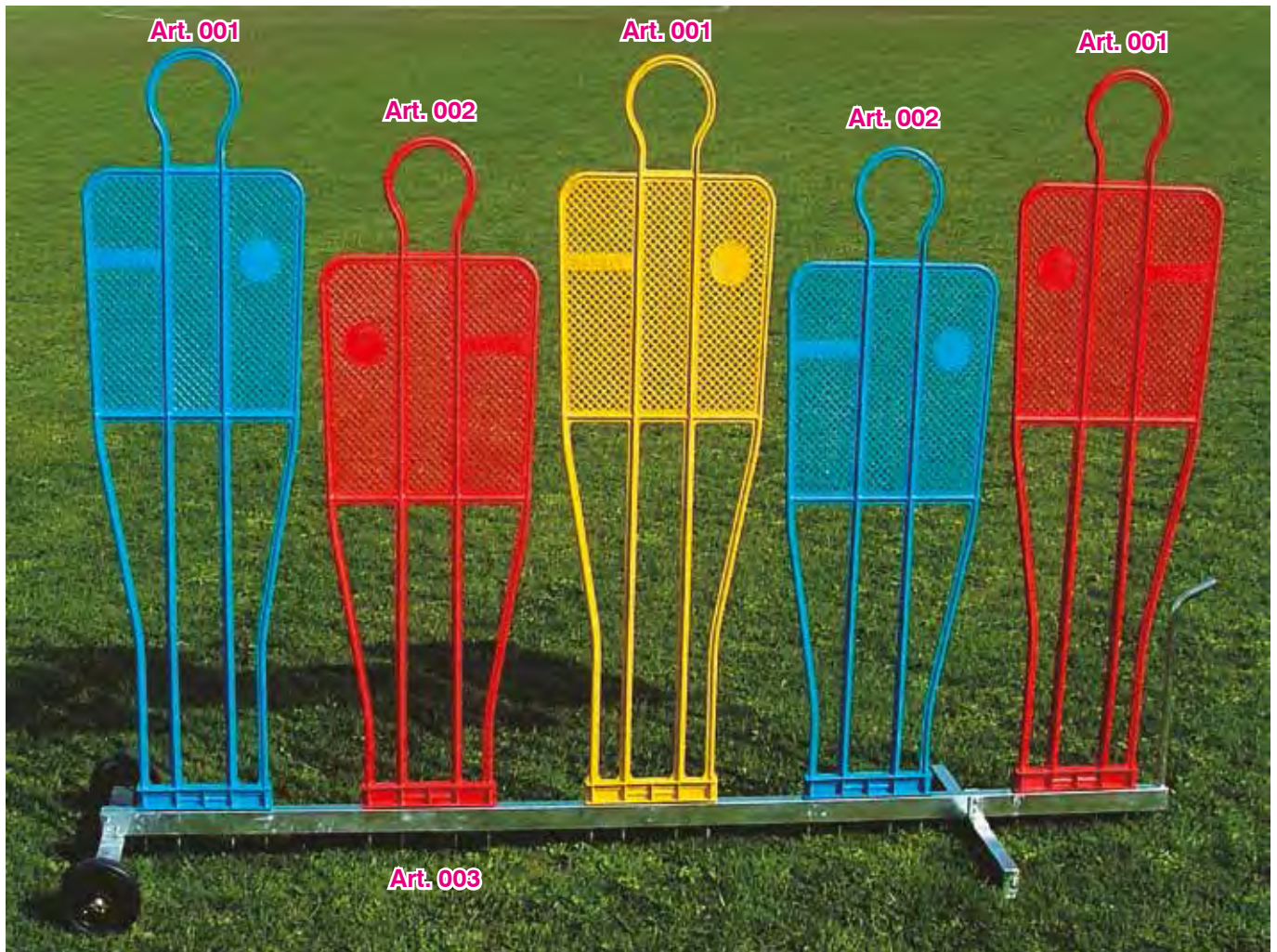

**3 x Art. 001 + 2 x Art. 002 + Art. 003**  
**Carrello con 5 sagome - trolley + 5 Barret Mannequins**



**4 puntali in acciaio zincato alla base per posizionamento su terreno naturale o su carrello porta sagome**  
4 galvanized steel spikes at the base, for easy positioning on natural grass or upon Barret trolley



**Art. 003 Carrello porta 5 sagome in acciaio zincato con ruote**  
**Trolley for carrying 5 Mannequins in galvanized steel, with wheels**



**SAGOME BARRET BREVETTATE**  
indispensabili per:  
*calci di punizione, slalom, dribbling,  
esercizi di anticipo, uscite aeree,  
schemi tattici ...*

**PATENTED BARRET MANNEQUINS**  
very useful for:  
*free kicks, slalom, dribbling, tackles,  
headers, goal-keeper exercises, tactics ...*



● pg.1

**BPS001**

**BORSA PORTA 5 SAGOME in nylon impermeabile con tracolla e maniglie,  
rinforzi laterali in polipropilene rigido**

Nylon carry bag for 5 mannequins with shoulder belt and handles - waterproof - reinforced on both sides





pg.1

**Art. 003RG**

**Carrello porta 5 sagome in acciaio zincato su ruote - regolabile a 4 altezze (la sagoma Art. 001 può arrivare ad un'altezza massima di cm.225)**

Trolley for 5 mannequins in galvanized steel on wheels - 4 adjustable heights (Art. 001 can reach up to 225 cm. height)

**Il carrello regolabile in altezza permette la simulazione di giocatori in barriera che saltano al momento del calcio di punizione**  
This trolley allows free kick practicing by simulating jumping defenders





**Art. 001  
+ Art. 003S**

**Art. 003S Carrello porta sagoma singola con molle antiribaltamento, in acciaio zincato su ruote**

Trolley for single mannequin in galvanized steel with springs, on wheels

pg.1

**Il carrello porta sagoma singola Art. 003S impedisce alla sagoma di cadere a terra se colpita dalla palla**

Trolley Art.003S allows mannequin to come back straight up when hit by the ball



**Art. 003S**



**Art. 001B**



**Art. 001  
+ Art. 001B**

**Art. 001B**

**Base porta sagoma zavorrabile in acciaio zincato, per posizionamento su terreni sintetici**

**Peso:**

**kg. 10 vuota,  
kg. 20 riempita con sabbia**

Galvanized steel base to be filled with sand for mannequin positioning on artificial grass.

Weight: 10 kg. empty  
20 kg. filled with sand



**Art. 002R**

**Art. 001R**

**Art. 001R**

**Rivestimento per Sagoma cm. 180 in nylon impermeabile antistrappo con cerniera**

**Colori: rosso, blu, giallo**

Nylon Cover for cm. 180 Mannequin with zip  
Colors: red, blue, yellow

**Art. 002R**

**Rivestimento per Sagoma cm. 160 in nylon impermeabile antistrappo con cerniera**

**Colori: rosso, blu, giallo**

Nylon Cover for cm. 160 Mannequin with zip  
Colors: red, blue, yellow



**5 x Art. 001 + 5 x Art. 001R**



**5 x Art. 001 + 5 x Art. 001R  
+ Art. 003RG**

pg.1



**LATO POSTERIORE  
BACK SIDE**



**Art. 001FE**  
**Sagoma Barret**  
**in acciaio zincato**  
**con 4 puntali**  
**altezza cm.180**  
**peso kg.5**  
 Barret mannequin  
 180 cm. height  
 in galvanized steel  
 with 4 spikes  
 weight 5 Kg.

**Art. 001FE**



**Art. 001FE**  
**+ Art. 001B**



**Art. 001FE**  
**+ Art. 001B**  
**+ Art. 001R**

pg.1



**Art. 002FE**

**Sagoma Barret in acciaio**  
**zincato con 4 puntali**  
**altezza cm.160**  
**peso kg.4,5**

Barret mannequin 160 cm.  
 height in galvanized steel  
 with 4 spikes weight 4,5 Kg.



**3 x Art. 001FE + 2 x Art. 002FE**  
**+ 2 x Art. 001R + 2 x Art. 002R**  
**+ Art. 003**



**Art. 001TD Rivestimento tridimensionale per sagoma Art. 001**  
h. cm. 180 spessore cm. 20  
in PVC monospalmato 360 gr/mq  
imbottitura in eliocell d. 16 kg/mc  
3D Cover 20 cm. thick  
for mannequin Art.001  
180 cm. height

**I RIVESTIMENTI TRIDIMENSIONALI SIMULANO PERFETTAMENTE IL VOLUME DEL CORPO DEI GIOCATORI PERMETTENDO UNA SERIE DI ESERCIZI TECNICI E TATTICI CON E SENZA PALLA ANCORA PIU' REALISTICI E SICURI. L'IMBOTTITURA E' INOLTRE UTILE PER PROTEGGERE LA SAGOMA DAGLI URTI DELLA PALLA CALCIATA AD ALTA VELOCITA' DURANTE GLI ALLENAMENTI AI CALCI PIAZZATI DI POTENZA**



**3D COVERS PERFECTLY RESEMBLE PLAYERS' BODIES ALLOWING EVEN MORE REALISTIC AND SAFE TECHNICAL AND TACTICAL EXERCISES WITH AND WITHOUT BALL. THE SOFT SANDWICH PROTECTIONS ALSO AVOID POSSIBLE DAMAGES CAUSED BY HIGH SPEED POWER FREE KICK PRACTISING**



pg.1

**Art. 002TD Rivestimento tridimensionale per sagoma Art.002**  
h.cm.160  
spessore cm. 20  
in PVC monospalmato 360 gr/mq  
imbottitura in eliocell d. 16 kg/mc  
3D Cover 20 cm. thick  
for mannequin Art.002  
160 cm. height



**Art. GP175**

**Sagoma in gommapiuma h. cm. 170 - rivestimento in PVC con decorazione digitale fronte-retro del giocatore, zavorrata alla base con sabbia peso kg. 27 con maniglie per il trasporto colori disponibili: rosso, blu, giallo, arancio, bianco**  
 Foam rubber Dummy 170 cm. height with PVC Cover with player's sketch weighted base with sand total weight 27 Kg. with handles available colors: red, blue, yellow, orange, white

**Nessun problema di forature, perdite d'aria o lacerazioni**  
 No problems with punctures, deflation or lacerations

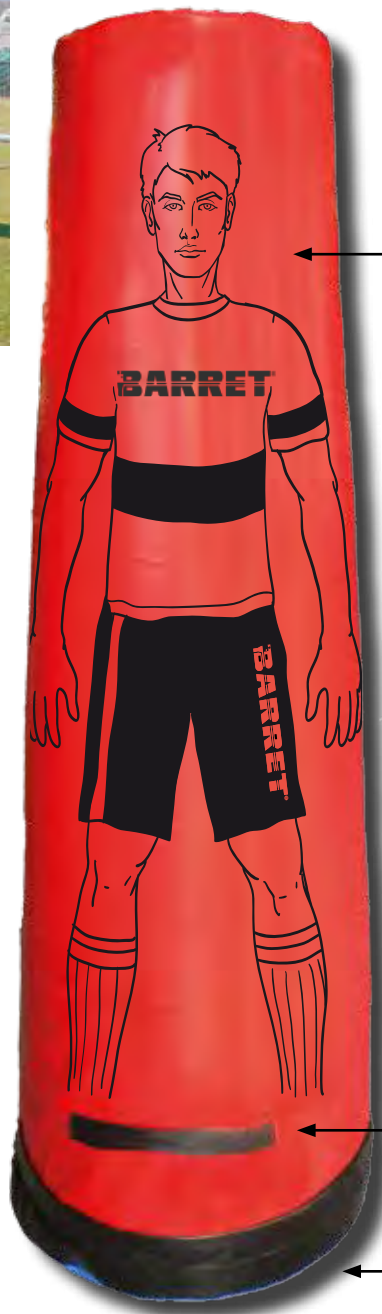

**Sempre in piedi**  
 Pop up dummy

**Rivestimento in PVC**  
 PVC Cover outside

**Imbottitura in poliuretano espanso**  
 Foam rubber inside

pg.1

**Art. GP205**

**Sagoma in gommapiuma h. cm. 205 - rivestimento in PVC con decorazione digitale fronte-retro del giocatore, zavorrata alla base con sabbia peso kg. 28 con maniglie per il trasporto colori disponibili: rosso, blu, giallo, arancio, bianco**  
 Foam rubber Dummy 205 cm. height with PVC Cover with player's sketch weighted base with sand total weight 28 Kg. with handles available colors: red, blue, yellow, orange, white

**Maniglia su entrambi i lati**  
 Handle on both sides

**Base zavorrata**  
 Weighted base

**Art. GP175SL**

**Sagoma in gommapiuma come Art. GP175 solo con logo BARRET (senza la decorazione del giocatore)**  
 Foam Rubber Dummy same of Art. GP175 but only with BARRET logo (without player's sketch)



**Art. GP205SL**

**Sagoma in gommapiuma come Art. GP205 solo con logo BARRET (senza la decorazione del giocatore)**  
 Foam Rubber Dummy same of Art. GP205 but only with BARRET logo (without player's sketch)

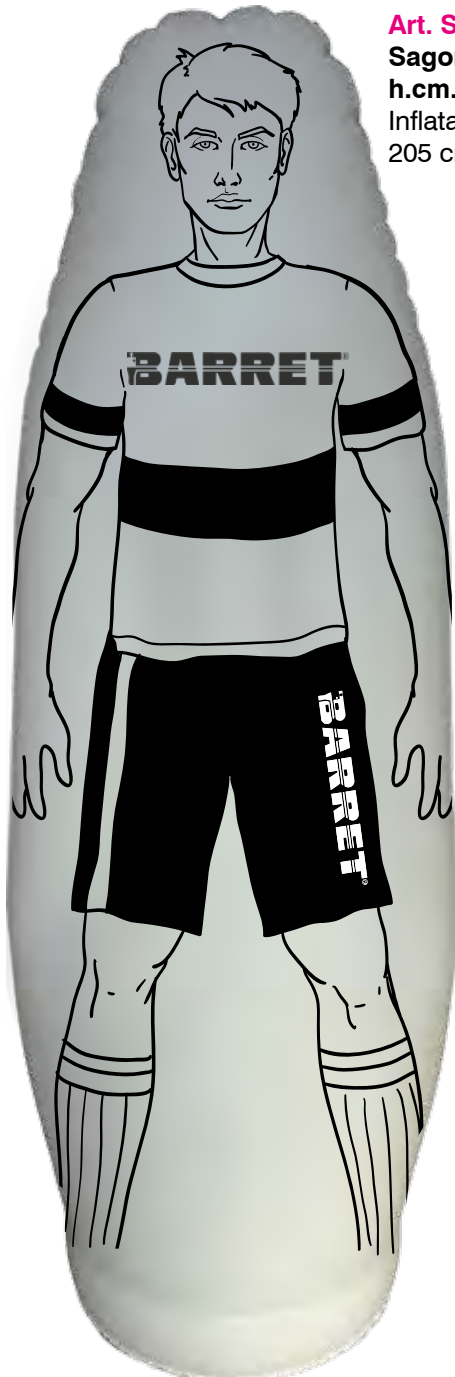

**Art. SAG205**  
**Sagoma Gonfiabile**  
**h.cm.205**  
Inflatable dummy  
205 cm. height

pg.1

**Art. SAG175**  
**Sagoma Gonfiabile h.cm.175**  
Inflatable dummy  
175 cm. height



**Art. SAG115**  
**Sagoma Gonfiabile h.cm.115**  
Inflatable dummy 115 cm. height

Ideale per i bambini  
delle scuole calcio  
best for soccer school kids



Ø base cm. 56 - peso kg. 23  
(pronta all'uso)  
base Ø 56 cm. - weight 23 Kg.  
(when ready for use)

Ø base cm. 45 - peso kg. 11  
(pronta all'uso)  
base Ø 45 cm. - weight 11 Kg.  
(when ready for use)

Ø base cm. 40 - peso kg. 7  
(pronta all'uso)  
base Ø 40 cm. - weight 7 Kg.  
(when ready for use)

**Art. KSG Kit di riparazione per sagoma gonfiabile**  
(n. 1 confezione di collante n. 3 porzioni di rivestimento)  
Repairing Kit for inflatable dummies (glue and 3 patches)

Per un ordine minimo di 100 pezzi per misura le sagome gonfiabili possono essere personalizzate  
Inflatable dummies can be customized: minimum order 100 pieces for each size

Se colpite dalla palla o dal corpo dei giocatori durante gli esercizi, le sagome gonfiabili Barret tornano in piedi da sole

Barret inflatable dummies always pop back up when hit by ball or players' body during exercises

Nate per l'allenamento dei portieri, le sagome gonfiabili Barret possono essere utilizzate anche per i calciatori per l'effettuazione di una molteplicità di esercizi tecnici e tattici con e senza palla

Born for GK training, Barret inflatable dummies are very useful for lots of tactical and technical exercises involving players with and without ball



Particolare della valvola superiore (rientrante) da utilizzare per il gonfiaggio della sagoma e della valvola inferiore (anch'essa rientrante) da utilizzare per il riempimento della base di appoggio a terra con acqua  
The upper valve to inflate the body with air, the bottom valve to fill the base with water

## ISTRUZIONI PER IL GONFIAGGIO E L'UTILIZZO DELLE SAGOME GONFIABILI

**IMPORTANTE: QUANDO È IN USO LA SAGOMA NON DEVE ESSERE COMPLETAMENTE GONFIA. IL CORPO DEVE RIMANERE SEMPRE MORBIDO, ED I FIANCHI NON DEVONO ESSERE MARCATAMENTE SPORGENTI VERSO L'ESTERNO RISPETTO ALLA BASE (FIANCHI E BASE ZAVORRATA DEVONO TROVARSI QUASI IN LINEA RETTA GLI UNI RISPETTO ALL'ALTRA)**

- 1) Gonfiare la sagoma non completamente
- 2) Tenendo la sagoma distesa a terra, riempire il serbatoio con acqua: quando la sagoma comincia ad inclinarsi verso l'alto, chiudere il tappo del serbatoio e metterla in posizione verticale
- 3) Per la sagoma h. cm. 205 il livello dell'acqua deve arrivare appena sopra il tappo del serbatoio: inclinando la sagoma di 15° si deve vedere una bolla d'aria sulla valvola trasparente. Per la sagoma h. cm. 175, invece, riempire completamente il serbatoio
- 4) Provare a spingere la sagoma lateralmente e osservare come torna in posizione eretta
- 5) Se si vuole che la sagoma si rialzi più velocemente, aggiungere dell'acqua (a discapito del peso) e gonfiare un po'
- 6) Se si gonfia ulteriormente la sagoma, distenderla a terra e fare uscire l'aria in eccesso dal serbatoio dell'acqua (il fondo deve essere piatto, non bombato)
- 7) Una volta trovato l'equilibrio desiderato, la sagoma può essere sgonfiata e rigonfiata (ad esempio, per trasportarla in luogo lontano) senza più svuotare il serbatoio dell'acqua
- 8) Se si utilizzano le sagome a basse temperature si consiglia di aggiungere alcol o antigelo nel serbatoio (non usare le sagome se l'acqua nel serbatoio è ghiacciata)
- 9) Non colpire le sagome con corpi appuntiti, non avvicinarle a fonti di calore, non trascinarle ma sollevarle sempre quando occorre spostarle, non sbatterle violentemente a terra
- 10) Per le riparazioni utilizzare l'apposito kit o Loctite 406 (altri prodotti non hanno efficacia sul materiale) Il prodotto è garantito solo per un utilizzo diligente che rispetti le istruzioni fornite



### USER'S INSTRUCTIONS

**IMPORTANT: WHEN USING YOUR DUMMY YOU ALWAYS HAVE TO KEEP THE BODY VERY SOFT, AND HIPS HAVE TO BE IN A STRAIGHT LINE WITH THE BASE (THEY MUST NOT BE ROUNDED)**

Inflatable dummies are entirely made with soft PVC: there are no rigid parts, so these products are absolutely safe. First, you have to inflate your dummy but not completely. Then, by keeping it lying on the floor, you have to fill the tank with water: when the dummy rises up, close the valve and place it upright

For dummies 205 cm. high the water level must reach just over the valve, while for dummies 175 cm. high the tank can be filled completely

If you want your dummy to rise up more quickly when hit, add some water and inflate the body a little more. In this case, let the dummy lie on the floor for a while and let some air out from the tank (the base must be flat, not rounded) Dummies can be used both on natural and artificial grass, on turf, gym floors etc.

Two side handles made of soft PVC are very useful to carry your dummy around: it is important to always lift your dummy when you need to move it (never pull it!) so the PVC base doesn't get scratched

When temperature is close to 0 degrees, it is necessary to add some alcohol inside the base (or some antifreeze liquid)

It is also available a kit for repair when inflatable dummies get damaged because used in wrong ways, in example when they are torn apart by players kicking with their studs against them



**Indistruttibili!**  
Unbreakable!



pg.1

**Art. 706244**  
**Sagoma in plastica rinforzata antiurto**  
**su carrello a 4 ruote**  
**altezza cm.190**  
**peso totale Kg.22**  
**(kg.7 la sagoma - Kg.15 il carrello)**  
**spessore sagoma cm.9**  
Mannequin in reinforced plastic  
9 cm. thick with 4 wheel trolley  
height 190 cm. weight 22 Kg.

**LATO ANTERIORE**  
**FRONT**



pg.1

**Art. 5026**  
**Sagoma**  
**Barret**  
**in vetroresina**  
**h. cm. 185**  
Fiberglass  
Mannequin  
185 cm. height

**LATO POSTERIORE**  
**BACK**



**Indistruttibili!**  
Unbreakable!

**4 puntali in acciaio**  
**zincato alla base, per**  
**posizionamento su**  
**terreno naturale**  
**o su carrello**  
**portasagome**

4 galvanized steel  
spikes at the base, for  
quick positioning on  
natural grass  
or on trolley



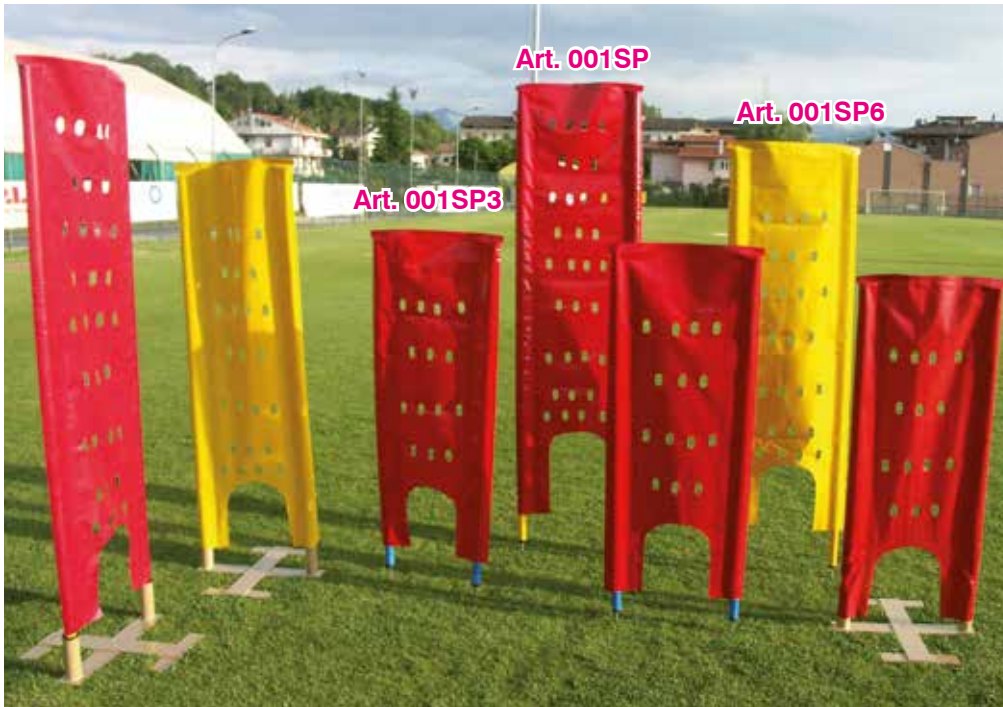

**Art. 001SP**  
**Sagoma Morbida telo PVC forato antivento con 2 Paletti in PVC h. cm. 170**  
 Soft pierced antiwind PVC Mannequin with 2 PVC Poles 170 cm. high

**Art. 001SP3**  
**Sagoma Morbida telo PVC forato antivento con 2 Paletti in PVC h. cm. 130**  
 Soft pierced antiwind PVC Mannequin with 2 PVC Poles 130 cm. high

**Art. 001SPA**  
**Sagoma Morbida telo PVC forato antivento con 2 Paletti in alluminio h. cm. 170**  
 Soft pierced antiwind PVC Mannequin with 2 aluminium Poles 170 cm. high

**Art. 001SP6**  
**Sagoma Morbida telo PVC forato antivento con 2 Paletti in PVC h. cm. 160**  
 Soft pierced antiwind PVC Mannequin with 2 PVC Poles 160 cm. high

● pg.1



**Art. SA001**  
**Supporto per sagoma morbida in ferro verniciato utilizzabile su terreno sintetico**  
 Base in painted iron for positioning any soft mannequin on artificial grass





La palla penetra all'improvviso attraverso le finestre senza perdere velocità

Telo cm.250x173  
250x173 cm. sheet

Ball goes through the windows without losing speed

**Art. 003WB**  
**BARRIERA CON FINESTRE**  
per l'allenamento ai calci di punizione e per il miglioramento dei tempi di reazione del portiere in caso di tiri improvvisi

**kit completo**  
WINDOW BARRIER for free kicks and Goal Keeper training to fast and sudden shots complete kit

**Art. 003WBS** pg.1  
**STRUTTURA SUPERIORE**  
barriera con finestre, applicabile al carrello porta sagome Art. 003  
Window Barrier UPPER PART to be fixed upon trolley Art. 003



**Art. 003RX**  
**BARRIERA FILTRANTE REFLEX** **kit completo**  
REFLEX FILTERING BARRIER on wheels - complete kit

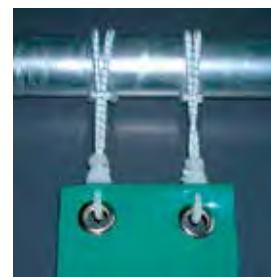

**Nuovo sistema di fissaggio**  
New more resistant elastics and hooks

pg.1

**Art. 003RXS**  
**STRUTTURA SUPERIORE** barriera filtrante REFLEX, applicabile al carrello porta sagome Art. 003  
Reflex Filtering Barrier UPPER PART to be fixed upon trolley Art. 003



**Art. 003RXS**

**Art. 003**

**INNOVATIVO ATTREZZO FONDAMENTALE PER L'ALLENAMENTO DEI RIFLESSI DEL PORTIERE. LA PALLA (INVISIBILE PER IL PORTIERE AL MOMENTO DEL CALCIO) FILTRA ATTRAVERSO LE STRISCE ED ARRIVA IN PORTA ALL'IMPROVISO ASSUMENDO TALVOLTA TRAIETTORIE IMPREVEDIBILI. ATTREZZO DA POSIZIONARE IN PROSSIMITÀ DELL'AREA PICCOLA**

**A revolutionary device for goal-keeper's reflex training. The goal-keeper cannot see the ball until it passes through the stripes. The direction of the ball is often unpredictable! To be placed not too far from goal-keeper's area**



**L'ATTREZZO PUO' INOLTRE ESSERE UTILIZZATO COME UNA COMUNE BARRIERA PER L'ALLENAMENTO DEI CALCI DI PUNIZIONE**  
**It is also very useful for free kick practising for both kicker and goal-keeper!**



## PALI SLALOM - Slalom Poles



Art. 007

pg.2



**Art. 007SP**  
Paletto senza puntale  
cm. 162  
PVC Ø mm. 32  
colore giallo, rosso,  
bianco, blu  
Pole 162 cm. high  
in PVC  
colors: yellow, red,  
white, blue

**Art. 007** Paletto con puntale  
cm. 170 - PVC Ø mm. 32  
colore giallo, rosso,  
bianco, blu  
Pole 170 cm. high in PVC with  
galvanized metal spike  
colors: yellow, red, white, blue

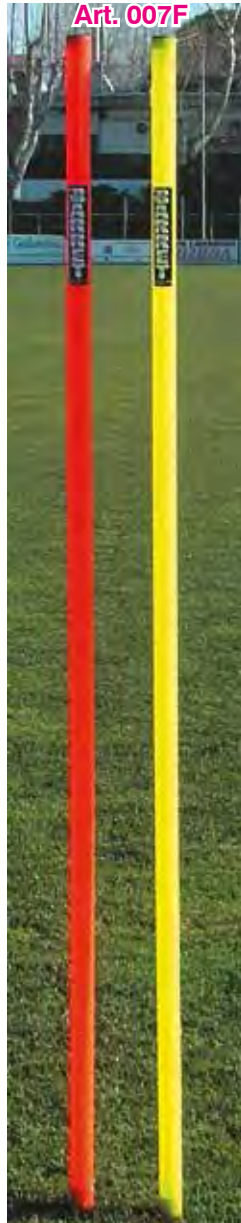

Art. 007F

**Art. 007F**  
Paletto in polipropilene  
copolimero Ø 32 mm h.cm.163  
con puntale zincato,  
colore giallo o arancio  
fluorescente  
Slalom Pole 163 cm. height in  
copolymer polypropylene 32mm.  
with galvanized metal spike  
(colors: fluorescent yellow and  
orange)



pg.2

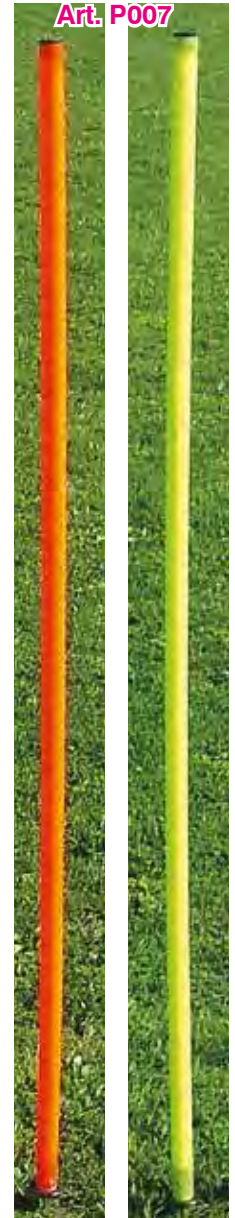

Art. P007

**Art. P007**  
Paletto cm. 160  
in polipropilene  
Ø mm. 30 con  
puntale e piattello  
di appoggio,  
colore giallo  
o arancio  
fluorescente  
Pole 160 cm. h. in  
polypropylene,  
metal spike with ring  
(colors: fluorescent  
yellow and orange)



**Art. A007**



pg.2



**Art. A007**  
Paletto cm. 170  
in alluminio Ø mm. 32  
con puntale zincato  
Pole 170 cm. high  
in aluminium with  
galvanized metal spike

**Art. AS007**



pg.2



**Art. AS007**  
Paletto flessibile  
cm. 170 in  
alluminio Ø mm.  
32 con puntale  
zincato e molla  
Pole 170 cm. h.  
in aluminium with  
galvanized metal  
spike and spring

**Art. S007**



**Art. S007**  
Paletto flessibile  
cm. 170 in  
PVC Ø mm. 32 con  
puntale  
zincato e molla,  
colore giallo o rosso  
Pole 170 cm. h.  
in PVC with  
galvanized metal  
spike and spring  
colors: yellow, red

**Art. 007TL**



cm. 170



cm. 90



**Art. 007TL**  
Paletto telescopico  
Ø 32 mm  
h. cm. 170 in PVC  
con puntale zincato  
(l'altezza si riduce  
sino a cm.90)  
colore giallo  
Telescopic Pole 170 cm.  
h. in PVC with galvanized  
metal spike  
Height can be reduced  
down to 90 cm.  
color yellow

**New!**

**Art. 007.25**  
Paletto  
cm. 170  
smontabile  
in PVC  
Ø 25 mm  
con puntale  
zincato svitabile  
colore giallo  
Dismountable  
Pole 170 cm.  
height in PVC  
with removable  
galvanized metal  
spike  
color yellow





**Art. 010**

**Art. 010**  
Paletto PVC  
Art. 007SP  
Ø 32 mm  
senza puntale  
+ base Art. 018  
Pole without  
metal spike  
+ base Art. 018



**Art. 010C**

**Art. 010C**  
Paletto PVC  
Art. 007SP Ø 32 mm  
senza puntale  
+ base Art. 902013  
Pole without  
metal spike  
+ base Art. 902013



**Art. 010WR**

**Art. 010WR**  
Paletto PVC  
Art. 007SP Ø 32 mm  
senza puntale  
+ base Art. HWRB  
Pole without  
metal spike  
+ base Art. HWRB





**Art. 018**  
Base in plastica  
per paletto Ø 32 mm  
con o senza puntale  
Plastic base  
for pole with  
or without metal spike



**Art. 902013**  
Base cilindrica in plastica  
riempibile con sabbia o  
acqua, solo per paletto  
Ø 32 mm senza puntale  
Cylindrical plastic base to  
be filled with sand or water,  
only for pole without  
metal spike

**Art. SP25** pg.2  
Asta in PVC Ø 25 mm.  
altezza cm. 152  
PVC pole Ø 25 mm.  
height 152 cm.



**Art. I-111**  
Clip ruotante  
per montanti  
Ø mm. 25 e 28  
Rotating clip  
for two pipes  
Ø mm. 25 and 28

**Art. E21**  
Traversa cm.120  
in PVC Ø mm. 25  
Crossbar 120 cm.  
in PVC Ø 25 mm.

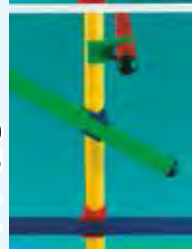

**Art. TAH-X**  
Base riempibile con  
sabbia per aste  
Ø 25 mm. e cerchi piatti  
o tubolari  
Base to be filled with sand  
for slalom poles Ø 25 mm.  
and flat or tubular hoops

pg.2



**Art. HWRB**  
Base in gomma appesantita  
per paletto Ø 32 mm con  
o senza puntale  
Weighted Rubber base  
for pole with  
or without metal spike



**Art. BFT** pg.2  
Borsa porta paletti  
(capienza massima 30 pezzi)  
Bag containing 30 poles

## DELIMITATORI - Markers

**SPECIFICARE I COLORI RICHIESTI AL MOMENTO DELL'ORDINE**  
**PLEASE, SPECIFY COLORS IN YOUR ORDER**



**Art. 016**

**Kit N° 48 Delimitatori h. cm.5 con rimessaggio**  
**colori disponibili:**  
**giallo, rosso, fucsia, arancio, blu, bianco**  
Kit N° 48 Markers h. 5 cm. with holder  
(available colors: yellow, red, fuchsia,  
orange, blue, white)

**Art. 016.1**

**Kit N° 48 Delimitatori h. cm.5 senza rimessaggio**  
**colori disponibili:**  
**giallo, rosso, fucsia, arancio, blu, bianco**  
Kit N° 48 Markers h. 5 cm. without holder  
(available colors: yellow, red, fuchsia,  
orange, blue, white)

**Art. 016.R5 Rimessaggio per delimitatori h. cm. 5 e cm. 7**  
Iron Holder for 5 cm. and 7 cm. height markers

**Art. 016.R Rimessaggio per delimitatori**  
**h. cm. 8 e delimitatori giganti Art. 016.K**  
Iron Holder for 8 cm. and giant markers

pg.3



**Art. 016.B**

**Kit N° 48 Delimitatori h. cm.8 con rimessaggio**  
**giallo fluo, rosso, fucsia, arancio fluo, blu, bianco**  
Kit N° 48 Markers 8 cm. height with holder  
(fluo yellow, red, fuchsia, fluo orange, blue, white)

**Art. 016.GA**

**Kit N° 48 Delimitatori h. cm.8 con rimessaggio**  
**colore giallo o arancio**  
Kit N° 48 Markers 8 cm. height with holder  
(available colors: yellow, orange)

**Art. 016.R5**



**Art. 016.R**



**Art. 016.T**



**Art. 016.T**

**Kit N° 48 Delimitatori h. cm. 7**  
**con rimessaggio**  
**e intagli sulla sommità**  
**colori disponibili: giallo e rosso**  
Kit N° 48 Markers with holder 7 cm. height carved on top  
(colors: red and yellow)



**Art. 016-TDC**  
**Raccoglitore in plastica per delimitatori con manico allungabile**  
 Adjustable length picking device for markers



**Art. OSPT15**  
**Delimitatore piatto Ø 15 cm**  
**colori giallo, rosso, arancio**  
 Flat round Marker Ø 15 cm.  
 colors: red, yellow, orange

**Ideale per**  
**superfici**  
**sintetiche!**  
 Great for indoor  
 and turf!



pg.3

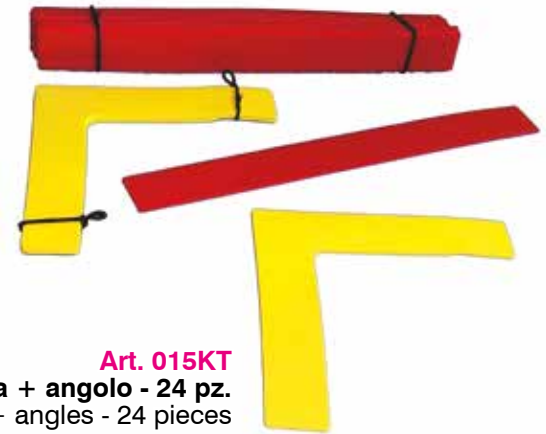

**Art. 015KT**  
**Kit linea + angolo - 24 pz.**  
 Kit Lines + angles - 24 pieces



**Art. 016.K**  
**Delimitatore gigante con scanalature**  
**Ø cm. 30 h. cm.15 peso gr. 100**  
**colori: giallo, arancio e bianco**  
 Giant Marker 15 cm. height  
 carved on top and sides  
 colors yellow, orange and white

**Art. 016.K**

pg.3



**Art. E21**

**Con l'uso**  
**di traverse**  
**consente**  
**la creazione**  
**di ostacoli**  
**di altezza**  
**cm. 5 / 10 / 15**  
 Giant markers  
 along with crossbars can  
 create hurdles  
 5-10-15 cm. high



**Art. E21 Traversa cm.120 in PVC Ø mm. 25 - colori giallo, rosso, blu, verde, bianco**  
 Crossbar 120 cm. in PVC Ø 25 mm. colors yellow, red, green, blue, white

pg.3

## BIRILLI - Cones

**Art. 205000**  
**Birillo calpestabile**  
**in caucciù termoplastico**  
**base Ø cm. 14 - h. cm. 15**  
**colore giallo o rosso**  
Soft Cone 15 cm. height  
14 cm. Ø base  
colors red and yellow



**Art. HA7**  
**Birillo calpestabile**  
**in caucciù termoplastico**  
**base Ø cm. 17**  
**h. cm. 18**  
**colori giallo,**  
**rosso, arancio**  
Soft Cone  
18 cm. height and  
17 cm. Ø base  
colors: red, yellow,  
orange

pg.4



**Art. 019**

**Art. 019**  
**Kit 24 Maxidelimitatori cm. 28**  
**colori: giallo, arancio, rosso,**  
**royal e fucsia**

Kit 24 Maximarkers, height 28 cm.  
colors: yellow, orange, red, blue  
and fuchsia

**Art. 019.1**  
**Maxidelimitatore cm. 28**  
**colori: giallo, arancio, rosso,**  
**royal e fucsia**

Maximarker height 28 cm.  
colors: yellow, orange, red, blue  
and fuchsia

pg.3

pg.4

**Art. 023E**  
**Birillo economico senza fori h. cm. 30**  
**colori rosso e giallo**  
Light Cone 30 cm. height with no holes  
colors: red and yellow







**Art. 023N**

**Birillo cm. 38 colore rosso, giallo o blu** - Cone height 38 cm. colors: red, yellow, blue  
**Peso gr. 200 senza foro sulla sommità** - Weight 200 gr. with no hole at top

pg.4



**Peso gr. 450**  
**Weight 450 gr.**

**Art. 023**

**Birillo giallo cm. 40 con foro sulla sommità**  
Yellow Cone with hole at the top

**Art. 025**

**Birillo fucsia cm. 40 con foro sulla sommità**  
Fuchsia Cone with hole at the top

**Art. 024**

**Birillo rosso cm. 40 con foro sulla sommità**  
Red Cone with hole at the top



**in 4 colori**  
**in 4 colors**

**Art. B312**

**Birillo a 8 fori h. cm. 30 con scanalatura sulla sommità**  
Cone with 8 holes 30 cm. height carved on top



**Art. E21 Traversa cm.120 in PVC Ø mm. 25 colori giallo, rosso, blu, verde, bianco**

Crossbar 120 cm. in PVC Ø 25 mm. colors yellow, red, green, blue, white



**Art. C21**  
**Birillo a 16 fori**  
**cm. 50 con scanalatura**  
**sulla sommità**  
**in 4 colori**  
 Cone with 16 holes  
 height 50 cm.  
 carved on top  
 in 4 colors

● pg.4



**Art. I-111**  
**Clip ruotante**  
**per montanti**  
**Ø mm. 25 e 28**  
 Rotating clip  
 for two pipes  
 Ø mm. 25 and 28

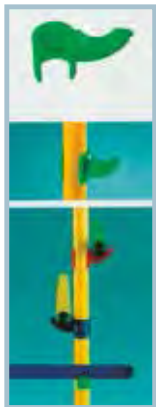

**Art. I-110**  
**Clip per montante**  
**Ø mm. 25 e 28**  
**e traversa**  
 Clip for pipe  
 Ø mm. 25 and 28  
 and crossbar

● pg.2



**Art. I-112**  
**Clip per montante**  
**Ø mm. 25 e 28**  
**e cerchio piatto**  
 Clip for pipe  
 Ø mm. 25 and 28  
 and flat hoop

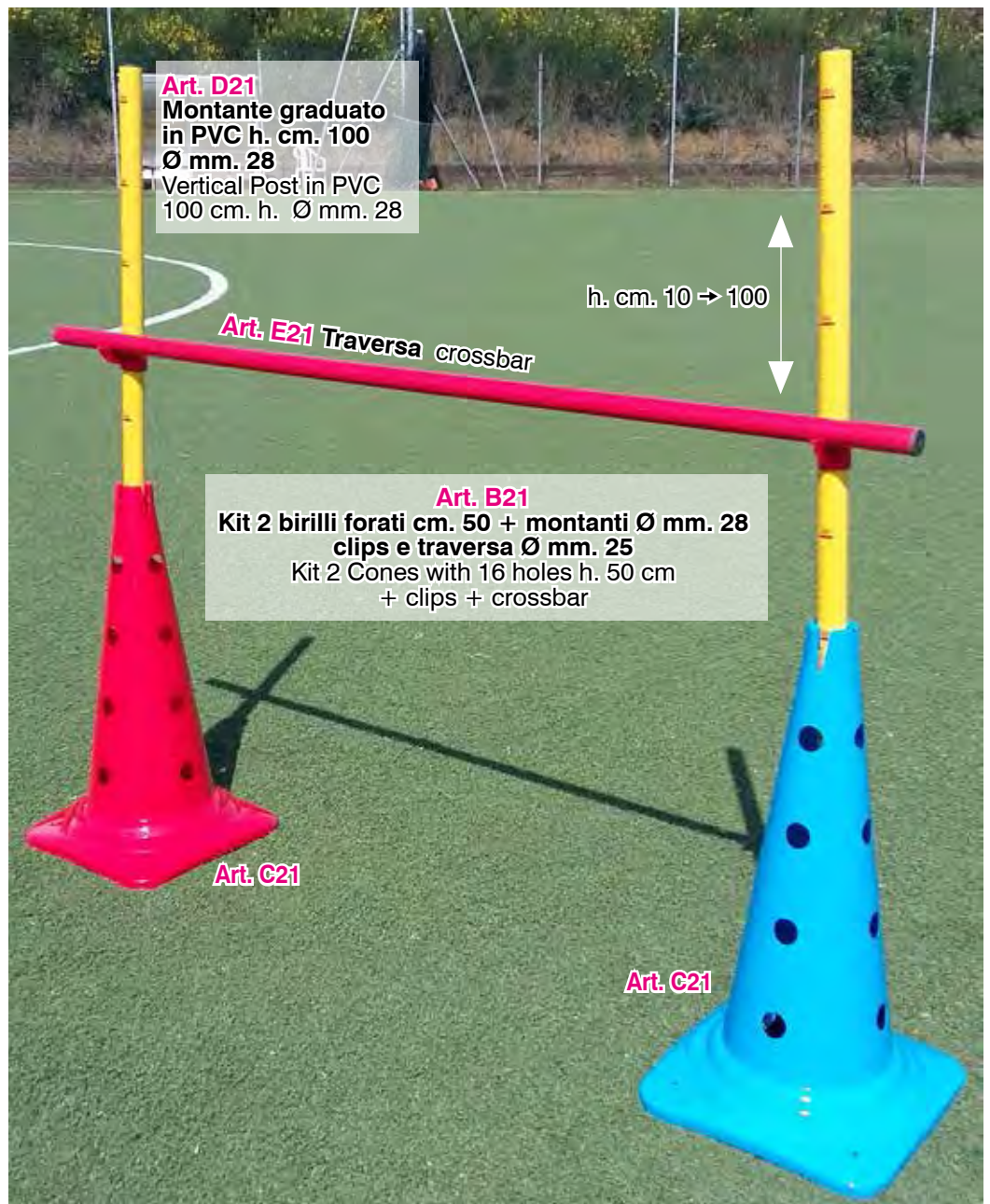

**Art. D21**  
**Montante graduato**  
**in PVC h. cm. 100**  
**Ø mm. 28**  
 Vertical Post in PVC  
 100 cm. h. Ø mm. 28

h. cm. 10 → 100

**Art. E21** Traversa crossbar

**Art. B21**  
**Kit 2 birilli forati cm. 50 + montanti Ø mm. 28**  
**clips e traversa Ø mm. 25**  
 Kit 2 Cones with 16 holes h. 50 cm  
 + clips + crossbar

**Art. C21**

**Art. C21**



**Art. 525**  
**Ostacolo regolabile con paletti,**  
**ritti e traversa in PVC Ø mm.32**  
 Hurdle with Poles,  
 clips and crossbar in PVC Ø 32 mm.

pg.3

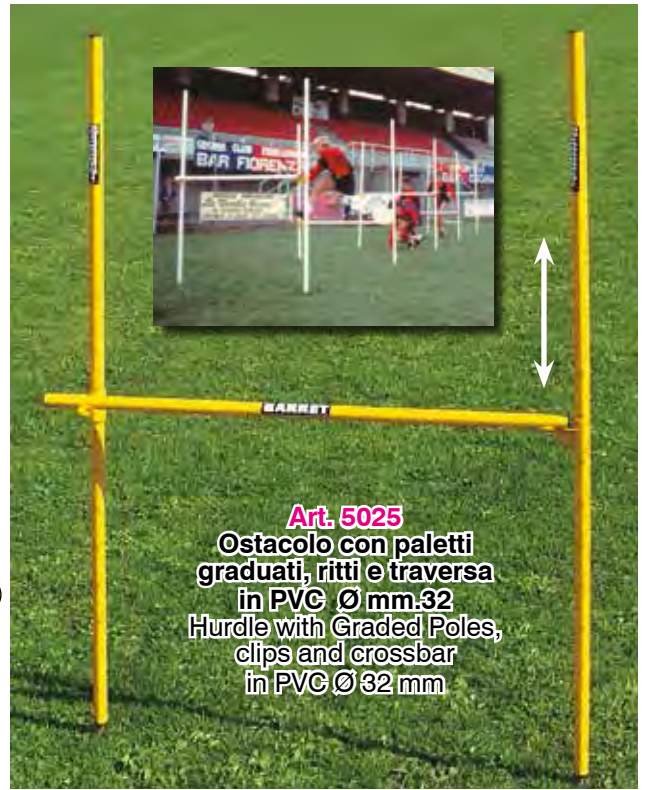

**Art. 5025**  
**Ostacolo con paletti**  
**graduati, ritti e traversa**  
**in PVC Ø mm.32**  
 Hurdle with Graded Poles,  
 clips and crossbar  
 in PVC Ø 32 mm

h. cm. 10 → 160



**Art. 012**  
**Traversa in PVC cm.110 Ø mm. 32**  
 Crossbar 110 cm. in PVC Ø mm. 32



**Art. 012F**  
**Traversa cm. 110 in polipropilene**  
**copolimero Ø mm.32**  
**giallo o arancio fluo**  
 Crossbar 110 cm. in copolymer  
 polypropylene Ø 32 mm.  
 in fluorescent yellow and orange



**Art. 525F**  
**Ostacolo regolabile**  
**costituito da 2 paletti h 170 cm. con**  
**puntale, 1 traversa e 2 clips**  
**in polipropilene copolimero**  
**colore giallo o arancio fluo**  
 Hurdle with graded poles, clips and  
 crossbar in copolymer polypropylene  
 Ø 32 mm. (colors: fluorescent yellow  
 and orange)

pg.3

h. cm. 10 → 160



**Art. 007SP**

**Art. ELNR**

**Art. ELNR**  
**ELASTICO nero con velcro**  
**lunghezza cm.135**  
**da fissare ai pali slalom**  
**come traversa**  
**ad altezza regolabile**  
 Black band length 135 cm.  
 with velcro  
 to be used as adjustable  
 height crossbar

**Art. 902013**



h. cm. 30 → 60  
**Art. 029** Ostacolo graduato con basi  
 altezza regolabile da 30 a 60 cm.  
 in PVC Ø mm. 32  
 Graded Hurdle with bases, adjustable  
 height from 30 to 60 cm.  
 in PVC Ø 32 mm

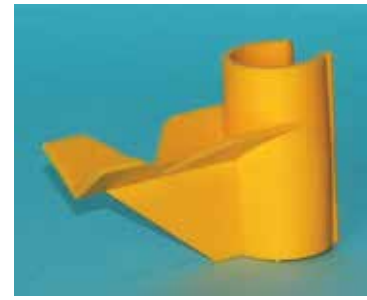

**Art. 011**  
 Clip per sostegno traversa  
 per tubo Ø mm. 32 o 28  
 Clip for crossbar for pipe  
 Ø mm. 32 o 28



h. cm. 40 → 100  
**Art. 030**  
 Ostacolo graduato con basi  
 altezza regolabile  
 da 40 a 100 cm.  
 in PVC Ø mm. 32  
 Graded Hurdle with bases  
 adjustable height  
 from 40 to 100 cm.  
 in PVC Ø 32 mm

pg.3



particolare

**New!**



pg.2

**Art. CL17**  
 Clip rotante per fissaggio  
 asta con asta  
 per paletti Ø mm. 32  
 Clip for poles  
 pipe Ø mm. 32



**Art. LL100**  
 Ostacolo regolabile in PVC costituito  
 da 2 montanti Ø mm. 25  
 altezza cm. 100  
 con basi riempibili con sabbia  
 e traversa cm. 100  
 Adjustable height PVC Hurdle  
 with 100 cm. poles,  
 100 cm. crossbar Ø 25 mm.  
 bases to be filled with sand

pg.3

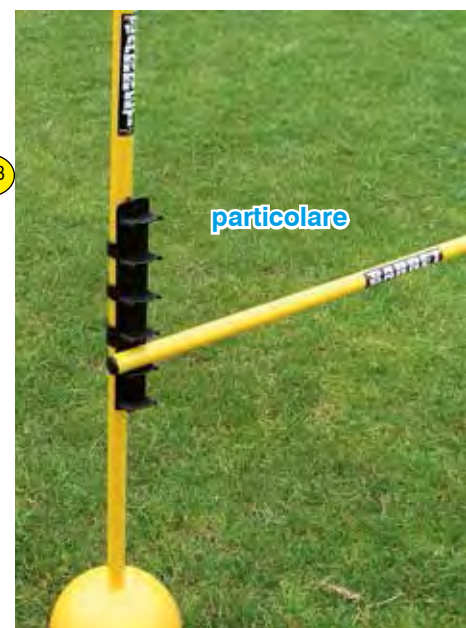

particolare

## OSTACOLI - Hurdles



pg.5

Art. MH6 / MH9 / MH12  
Mini-Over in PVC  
altezza fissa,  
cm. 15 / 23 / 30  
Ideali per i bambini  
delle scuole calcio

Mini-Over in PVC  
fixed height,  
15 / 23 / 30 cm.  
Best for soccer  
school kids



pg.4

Tornano in posizione  
dopo ogni urto  
senza danneggiarsi  
These hurdles come  
back in position after  
any hit without being  
damaged

Art. 80.12 / 80.14 / 80.16 / 80.18  
80.20 / 80.30 / 80.40 / 80.50 / 80.60  
Ostacolo Over in PVC  
altezza fissa,  
cm.12-14-16-18-20-30-40-50-60  
Hurdle Over in PVC  
fixed height,  
12-14-16-18-20-30-40-50-60 cm.

pg.4

Art.  
P031-A / P031 / P032  
P033 / P034 / P035  
Ostacolo Over  
in PVC Ø mm. 32  
altezza fissa  
disponibile  
da 12 a 60 cm.  
Hurdle Over in PVC,  
fixed height  
available  
from 12 to 60 cm.



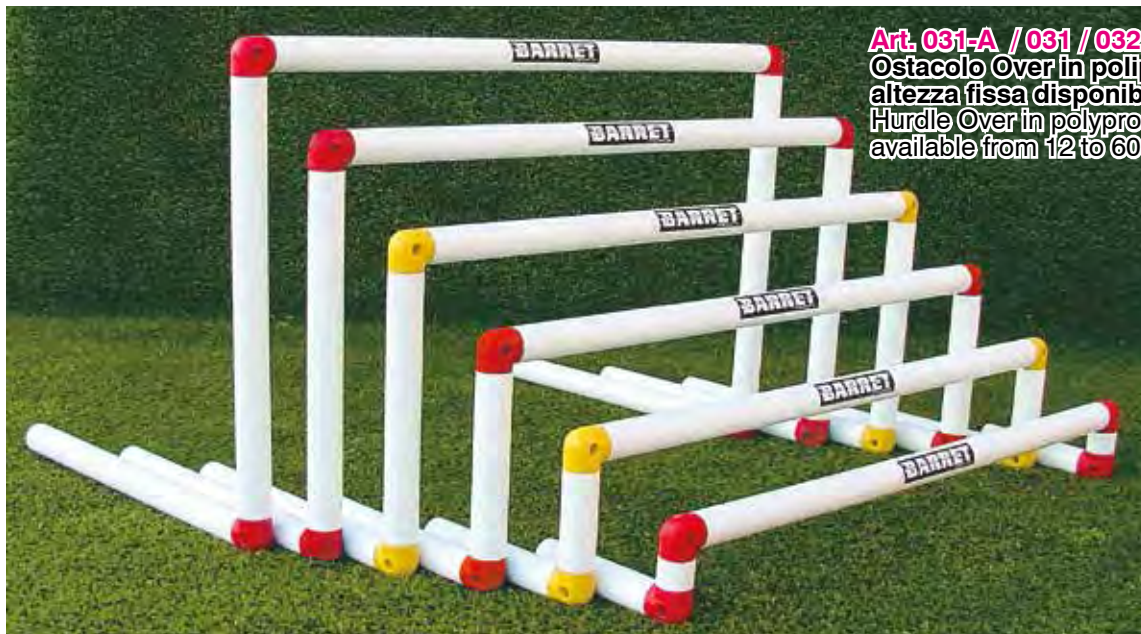

**Art. 031-A / 031 / 032 / 033 / 034 / 035**  
**Ostacolo Over in polipropilene Ø mm. 40**  
**altezza fissa disponibile da 12 a 60 cm.**  
**Hurdle Over in polypropylene, fixed height**  
**available from 12 to 60 cm.**

**Polipropilene**  
**copolimero**  
**Ø 40 mm.**  
**altamente**  
**resistente e**  
**flessibile fino a**  
**-5 gradi!**  
**Polypropylene**  
**copolymer**  
**40 mm. highly**  
**resistant and**  
**elastic till minus**  
**5 degrees!**

pg.5



**Art. 235.1 / 235.2 / 235.3 / 235.4 / 235.5 / 235.6**  
**Ostacolo Over**  
**in ferro verniciato altezza fissa**  
**disponibile da 12 a 60 cm.**  
**Hurdle Over in painted iron,**  
**fixed height available**  
**from 12 to 60 cm.**



pg.5

**Art. A031-A / A031 / A031-B / A032 / A033 / A034 / A035**  
**Ostacolo Over in alluminio Ø mm. 32 altezza fissa disponibile da 12 a 60 cm.**  
**Hurdle Over in aluminium, fixed height available from 12 to 60 cm.**

pg.4

pg.5

**Art. 031-AF**  
**031F / 031-BF / 032F**  
**033F / 034F / 035F**

**Ostacolo over**  
**altezza fissa**  
**cm. 12-20-30-40-50-60**  
**in polipropilene**  
**copolimero**  
**alta resistenza**  
**Ø mm. 32**  
**colori: giallo e arancio**  
**fluorescente**  
Over Hurdle 12 - 20 - 30  
40 - 50 - 60 cm. height  
polypropylene  
copolymer  
pipe Ø mm. 32  
(colors: fluorescent  
yellow and orange)



**Polipropilene**  
**copolimero**  
**FLUO**  
**altamente**  
**resistente e**  
**flessibile fino a**  
**-5 gradi!**  
Polypropylene  
copolymer  
fluorescent  
highly  
resistant and  
elastic till minus  
5 degrees!

**Art. C031 / C032 / C033 / C034**

**Ostacolo Over**  
**con cerniere (richiudibile) in**  
**polipropilene**  
**copolimero Ø mm. 32**  
**colore giallo o arancio**  
**fluorescente**  
**massima altezza**  
**cm. 20 - 30 - 40 - 50**  
Hinged Hurdle Over  
(foldable) in polypropylene  
copolymer pipe Ø mm. 32  
fluorescent yellow and orange  
20 - 30 - 40 - 50 cm.  
maximum height

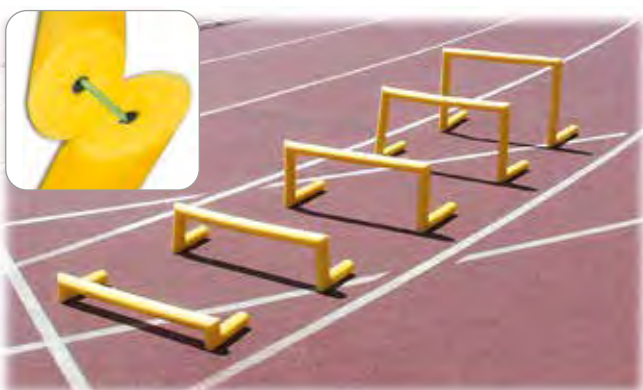

pg.5

**Art. P15421**

**Serie 5 ostacoli Over supersoft in polietilene**  
**espanso colore giallo, leggerissimi**  
**ideali per uso indoor**  
**altezza cm. 10-20-30-40-50 (il set comprende**  
**un ostacolo per ciascuna altezza)**  
Set of 5 Hurdles over supersoft yellow color  
very light, best for indoor use  
fixed height cm. 10-20-30-40-50



pg.6

**Art. 006**  
**Ostacolo con cerniere (richiudibile)**  
 altezza regolabile da 10 a 60 cm.  
 in PVC Ø mm. 32  
 Hinged Hurdle (foldable)  
 adjustable height  
 from 10 to 60 cm. in PVC

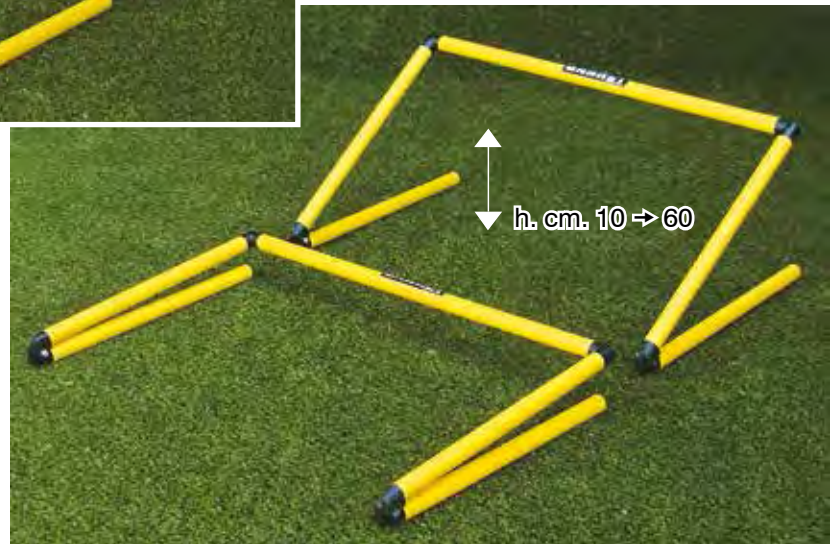

pg.6

**Art. 006F**  
**Ostacolo con cerniere (richiudibile)**  
 altezza regolabile da 10 a 60 cm.  
 in polipropilene copolimero Ø mm. 32  
 colore giallo o arancio fluorescente  
 Hinged Hurdle (foldable) adjustable height  
 from 10 - 60 cm. in polypropylene  
 copolymer pipe Ø mm. 32  
 (colors: fluorescent yellow and orange)



pg.6

**Art. A004** **Ostacolo con cerniere (richiudibile)**  
 altezza regolabile da 10 a 60 cm.  
 in alluminio Ø mm. 32  
 Hinged Hurdle (foldable) adjustable height  
 from 10 to 60 cm. in aluminium





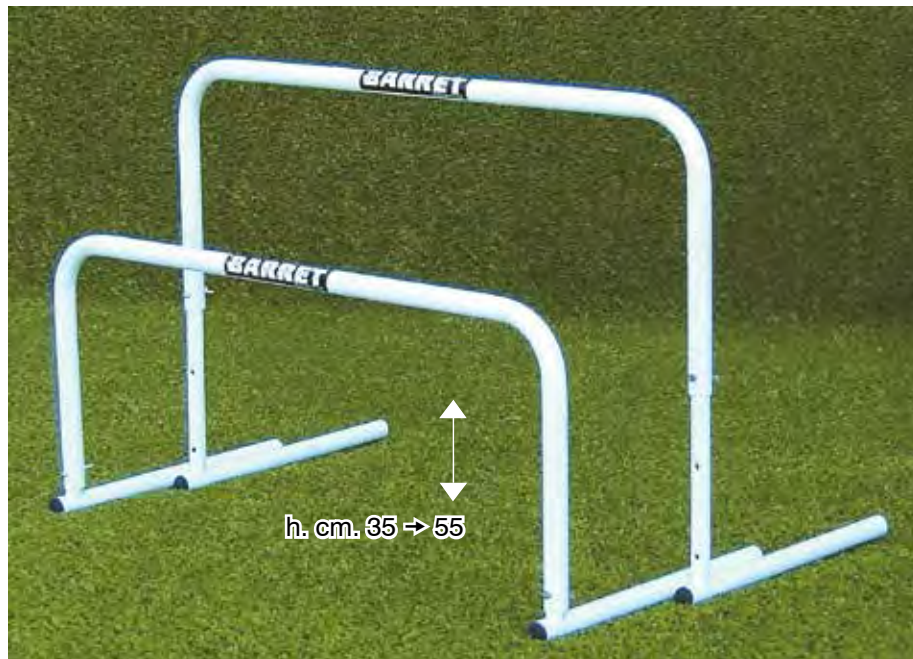

**Art. 236**  
**Ostacolo Telescopico regolabile da 35 a 55 cm. in ferro verniciato**  
Telescopic Hurdle adjustable height from 35 to 55 cm. in painted iron

pg.6

**Art. 237**  
**Ostacolo Telescopico regolabile da 60 a 90 cm. in ferro verniciato**  
Telescopic Hurdle adjustable height from 60 to 90 cm. in painted iron

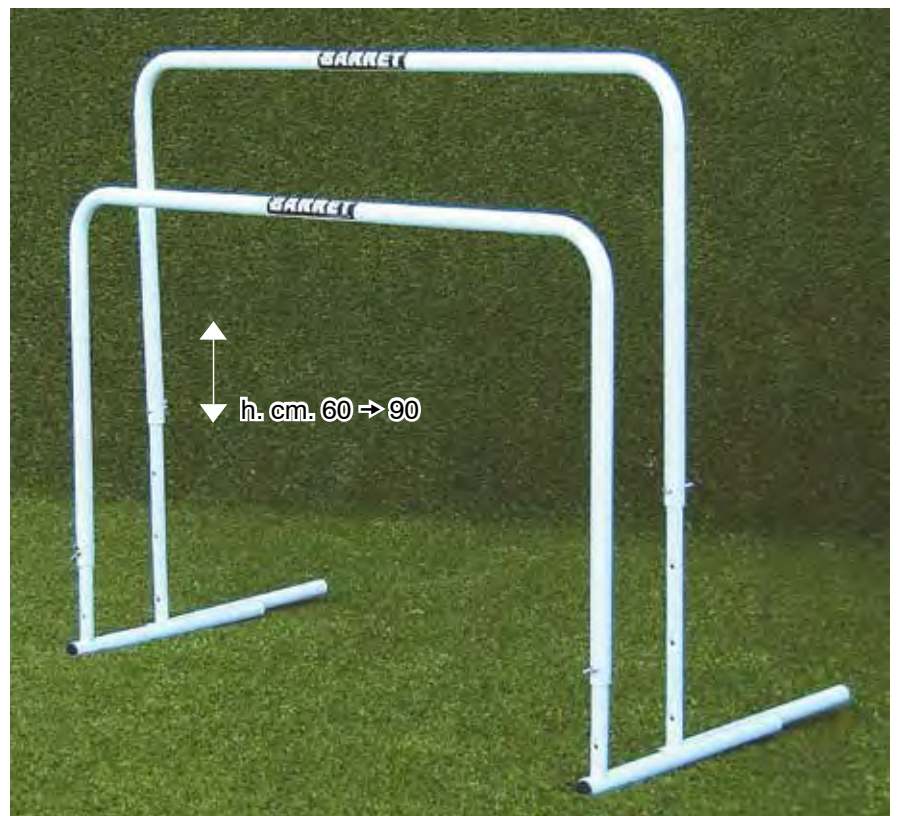

**Art. 036**  
**Mini Ostacolo regolabile da 10 a 50 cm. in plastica**  
Mini-Hurdle adjustable height from 10 to 50 cm. in plastic

**IDEALI PER USO INDOOR E PER PALESTRE**

**For indoor use**

**Art. P0055**  
**Ostacolo Telescopico graduato, altezza regolabile da 40 a 60 cm. in PVC**

Telescopic Hurdle - graded - height adjustable from 40 to 60 cm. in PVC

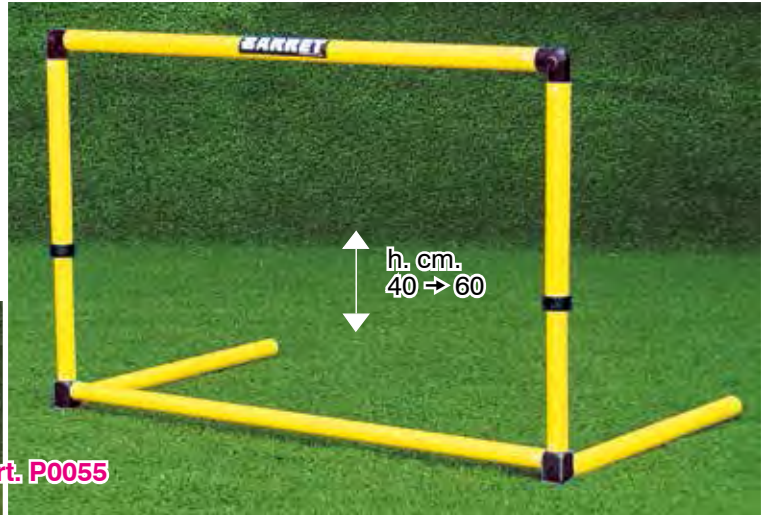

**Art. P0055**

**Completamente smontabili, minimo ingombro!**  
 Dismountable legs, easy to transport

pg.6

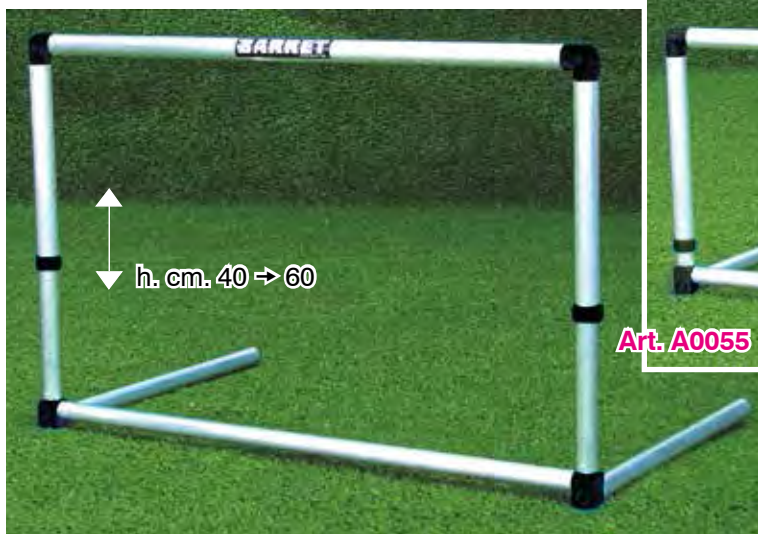

**Art. A0055**

**Art. A0055**  
**Ostacolo Telescopico graduato, altezza regolabile da 40 a 60 cm. in alluminio**  
 Telescopic Hurdle - graded - height adjustable from 40 to 60 cm. in aluminium

**Montanti graduati in cm.**  
 Graded in cm.

**Completamente smontabili, minimo ingombro!**  
 Dismountable legs, easy to transport



**Art. P005**  
**Ostacolo Telescopico graduato,**  
**altezza regolabile da 60 a 100 cm. in PVC**  
Telescopic Hurdle - graded - height adjustable  
from 60 to 100 cm. in PVC

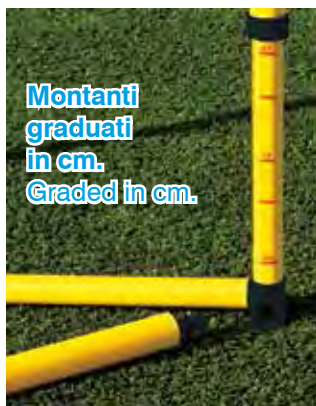
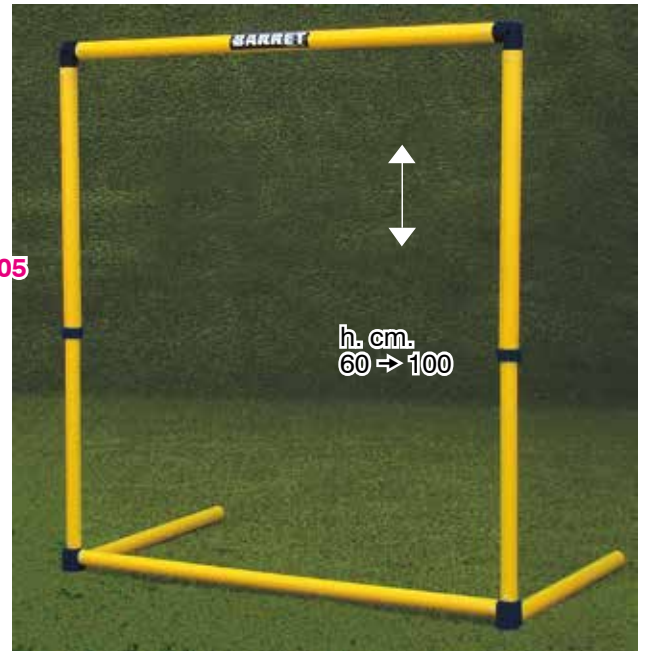
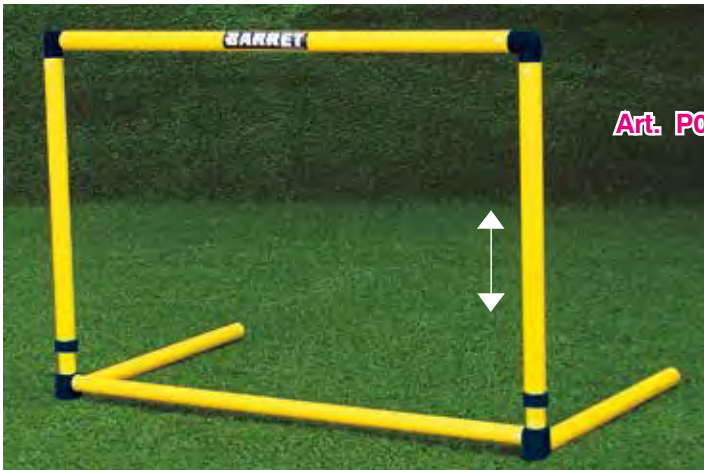

**Completamente smontabili,**  
**minimo ingombro!**  
Dismountable legs,  
easy to transport



**Art. A005** pg.6  
**Ostacolo Telescopico graduato,**  
**altezza regolabile da 60 a 100 cm. in alluminio**  
Telescopic Hurdle - graded  
height adjustable from 60 to 100 cm. in aluminium

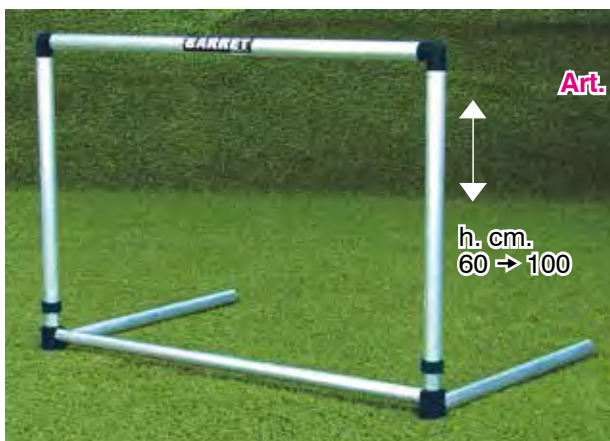

**Completamente smontabili,**  
**minimo ingombro!**  
Dismountable legs,  
easy to transport





**SEMPRE IN PIEDI  
DOPO OGNI URTO!  
THEY ALWAYS COME  
BACK UP AFTER  
ANY HIT!**



pg.5

**Art. 5020 / 5021 / 5022 / 5023**  
**Ostacolo Basculante in PVC Ø mm. 28**  
**altezza fissa cm. 30 / 40 / 50 / 60**  
Self-Straightening Hurdle in PVC fixed height,  
available in 30 / 40 / 50 / 60 cm.

pg.5

**Art. A5020 / A5021 / A5022 / A5023**  
**Ostacolo Basculante in alluminio Ø mm. 28**  
**altezza fissa cm. 30 / 40 / 50 / 60**  
Self-Straightening Hurdle in aluminium  
fixed height, available in 30 / 40 / 50 / 60 cm.



**SEMPRE IN PIEDI  
DOPO OGNI URTO!  
THEY ALWAYS COME  
BACK UP AFTER  
ANY HIT!**



## KIT CALCIO TENNIS - Soccer Tennis Kits

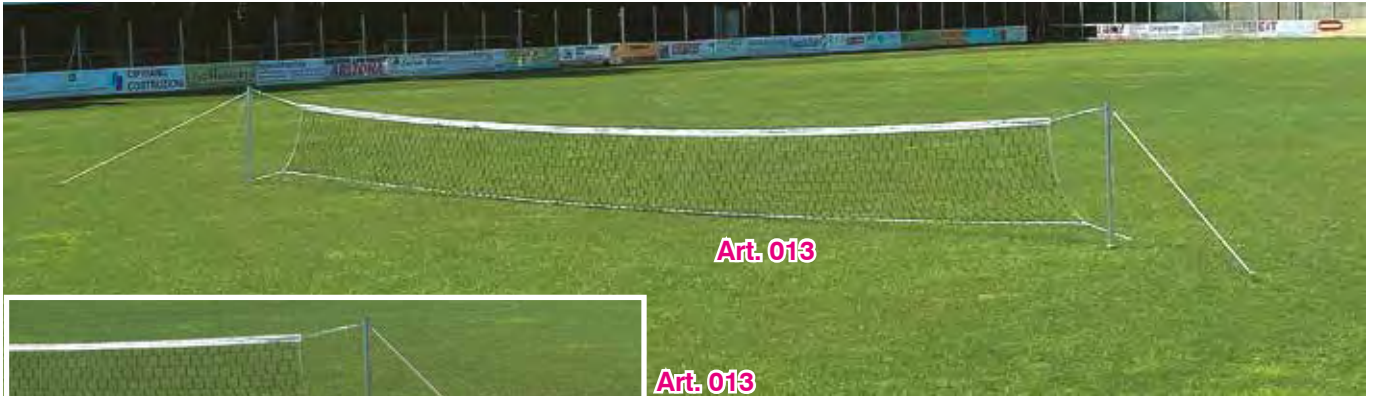

Art. 013



Art. 013

**Kit Calcio Tennis pali in alluminio sezione 60 mm. completo di rete mt. 9, tiranti, picchetti e delimitazione utilizzabile solo su terreni naturali**  
Soccer Tennis Kit aluminium poles 60 mm. with 9 meter net, tightening ropes, pegs and tape for bounds - for natural grass

pg.6



Art. 014

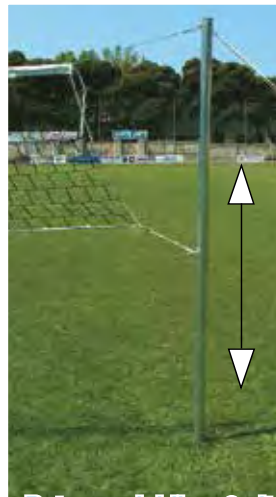

**Art. 014**  
**Kit Calcio Tennis pali in alluminio sezione 60 mm. completo di rete mt. 9 regolabile a 3 altezze (cm. 110/170/230) con tiranti, picchetti e delimitazione utilizzabile solo su terreni naturali**  
Soccer Tennis Kit aluminium poles 60 mm. with 9 meter net adjustable at 3 different heights, tightening ropes, pegs and tape for bounds - for natural grass

Rete regolabile a 3 altezze  
Adjustable height net

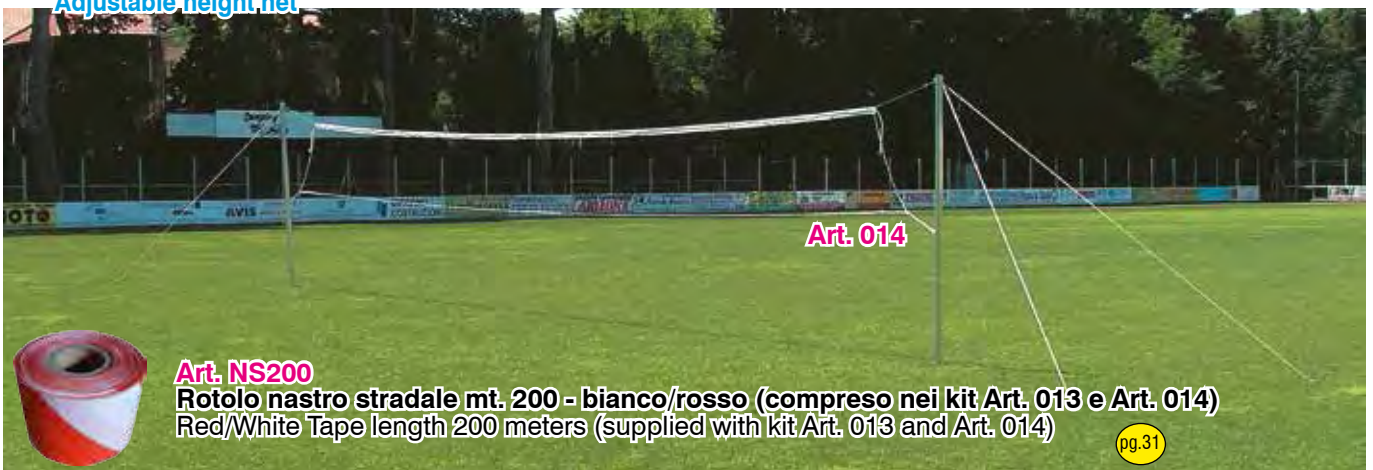

Art. 014



**Art. NS200**  
**Rotolo nastro stradale mt. 200 - bianco/rosso (compreso nei kit Art. 013 e Art. 014)**  
Red/White Tape length 200 meters (supplied with kit Art. 013 and Art. 014)

pg.31



**Art. 013.N**  
**Kit Calcio Tennis pali in PVC**  
**completo di rete mt. 3,30**  
**tiranti e picchetti**  
**per terreni naturali**  
Soccer Tennis Kit PVC poles  
with 3,30 meter net  
tightening ropes and pegs  
for natural grass

pg.6



**Art. 013.G** Kit calcio tennis pali in PVC  
con rete mt.10 - altezza cm.130  
con tiranti, picchetti e sacca  
per terreni naturali  
Soccer Tennis Kit PVC poles  
10 meter long 130 cm. height net with  
ropes, steel hooks and bag  
for natural grass



pg.6

**Art. 013.P**  
**Kit calcio tennis**  
**con rete mt. 3**  
**utilizzabile anche**  
**su terreni sintetici**  
**o indoor**  
**con sacca**  
Soccer Tennis Kit  
3 meter net - with bag  
also for artificial  
grass or indoor

**Art. 013.SP**

**Kit calcio tennis con rete cm.**

**450x170**

**utilizzabile anche  
su terreni sintetici o indoor**

**con sacca**

Soccer Tennis Kit 4,5x1,7 meter net  
with bag, also for artificial grass  
or indoor



pg.6

**Art. 013.60**

**Kit calcio tennis**

**con rete cm. 600x90**

**utilizzabile anche  
su terreni sintetici  
o indoor** con sacca

Soccer Tennis Kit  
6,0x0,9 meter net  
with bag, also  
for artificial grass  
or indoor



**Art. 013.S**

**Kit Calcio Tennis TATTICO**

**pali in polipropilene**

**completo di rete in PVC mt. 2,30 regolabile in**

**altezza, tiranti e basi in ferro verniciato**

**utilizzabile anche su terreni sintetici o indoor**

Soccer Tennis Kit polypropylene poles  
with adjustable height PVC net 2,30 meter long,  
tightening ropes and painted steel bases  
also for artificial grass or indoor

**Nasconde per qualche istante la visione  
del pallone, determinando risposte a livello  
neuromuscolare e migliorando cinestesia e  
sensibilità nel tocco di palla**

This Soccer Tennis Kit hides the ball from  
player's visibility stimulating neuro muscular  
reflexes and improving ball control

pg.6



**Art. 013.SB**

**Borsa per Kit calcio tennis**

**Art. 013.S**

Bag to carry soccer tennis  
kit Art. 013.S





**Art. T10076**  
**Coordinatore di Frequenza / Calcio tennis**  
**lunghezza m. 5 utilizzabile anche su superfici sintetiche**  
**attrezzo sicuro, privo di picchetti in metallo**  
 Speed Ladder / Soccer Tennis Kit  
 length 5 meters - also for indoor or artificial grass  
 safe without any metal spikes

**Ideale per i bambini delle scuole calcio**  
**best for soccer school kids**





## ARCHI DI PRECISIONE - Precision passing arcs

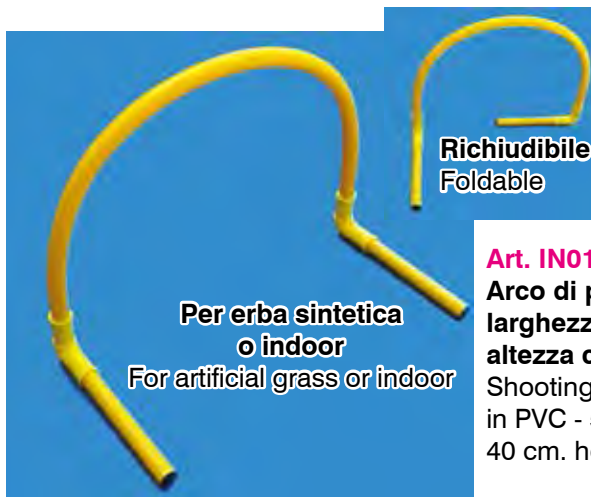

pg.6



**Art. 020 / 021 / 022**  
Arco di precisione in polipropilene  
Ø 40 mm. cm. 45x45 / 40x40 / 35x35  
Shooting/Passing Arc  
in polypropylene Ø 40 mm.  
dim. 45x45 / 40x40 / 35x35 cm.



**Art. A020 / A021 / A022**  
Arco di precisione  
in alluminio Ø 32 mm.  
cm. 45x45 / 40x40 / 35x35  
Shooting/Passing Arc  
in aluminium Ø 32 mm.  
dim. 45x45 / 40x40 / 35x35 cm.



## FORCHE - Heading Trellises



**Art. F203**

pg.6

**Art. F203**

**Forca doppia  
in ferro verniciato  
telescopica, smontabile  
bussola inclusa  
altezza da terra cm. 300  
(palloni esclusi)**

Double Heading Trellis  
in painted iron  
telescopic, dismantable,  
underground base included,  
height 300 cm. off ground  
(balls not included)



pg.6

**Art. 037F**

**Forca singola  
in acciaio zincato,  
con zavorra,  
per erba sintetica o indoor  
altezza da terra cm.300  
(pallone escluso)**

Single Heading Trellis  
in galvanized iron weighted for  
artificial grass or indoor  
height 300 cm. off ground  
(ball not included)



**Art. ULTVE5**

**Pallone per forca  
Trial n. 5  
in gomma  
doppio strato  
gr. 420  
Ø cm. 21,5**

Trial rubber Ball  
for Heading trellis  
size 5  
double stratum

pg.7

**Art. ULTVE4**

**Pallone per forca Trial n. 4  
in gomma doppio strato gr. 250 Ø cm. 20**  
Trial rubber Ball for Heading trellis size 4 double stratum



**Art. 038**  
**Forca doppia**  
**in alluminio**  
**tubo sezione 60 mm.**  
**altezza da terra cm.300**  
**(palloni esclusi)**  
 Double Heading Trellis  
 in aluminium  
 pipe section 60 mm.  
 300 cm. height off ground  
 (balls not included)

**Art. B038**  
**Bussola per forca**  
**(optional)**  
 Underground Base  
 (optional)

pg.6



**Art. 039.4 / 039.5**  
**Pallone per**  
**forca in pelle sintetica**  
**disponibile mis. 4 e 5**  
 Ball for Heading Trellis,  
 in synthetic leather  
 available size 4 and 5

pg.7



pg.10

**Con questo attrezzo**  
**è possibile verificare**  
**giornalmente i**  
**miglioramenti**  
**nell'elevazione**  
**degli atleti**  
 This instrument tests  
 players' daily jump  
 improvements

**Art. HJT Head Jump Tester - strumento polivalente di misurazione ed allenamento, permette la valutazione delle qualità muscolari degli arti inferiori, dell'elevazione dei giocatori, del loro modo di colpire la palla di testa e dell'ampiezza del tuffo del portiere**  
 Instrument that allows the training and measurement of jump ability of players and goal-keepers

**MURI - TELAI CON RETE - Rebounders - Iron frames with nets**

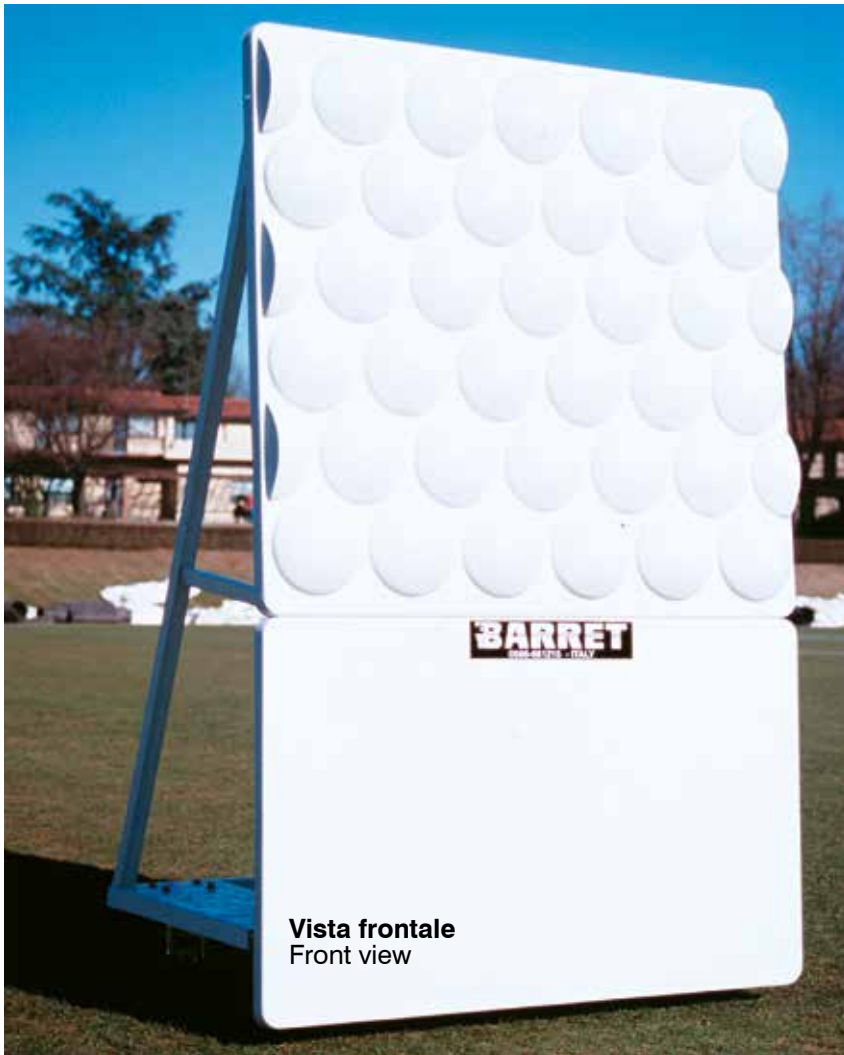

**Vista frontale**  
Front view



**Vista laterale**  
side view

**Art. 5011**  
**Muro per allenamento portieri in vetroresina**  
**montato su 4 ruote**  
Fiberglass Goal-Keeper Rebounder on 4 wheels

pg.7

**Dimensioni:**  
altezza cm.200  
larghezza cm.130  
Peso Kg.100

Dimensions:  
height 200 cm.  
width 130 cm.  
weight: 100 Kg.

**Calciando o lanciando la palla**  
**verso il muro essa assumerà**  
**direzioni di rimbalzo**  
**imprevedibili, favorendo**  
**l'allenamento dei riflessi**  
**del portiere**

By kicking or throwing the ball  
against the wall it will rebound in  
different directions,  
testing and training GK's reflexes



**Vista posteriore**  
Back view

**Consente l'allenamento con o senza il**  
**preparatore atletico**  
goalkeeper can exercise by himself  
as well



**Con superficie superiore a semisfere e**  
**superficie inferiore liscia**  
Upper side with hemispheres  
and smooth lower side



Kg. 50

**Art. 5010**

**Muro per allenamento giocatori a 3 facce in vetroresina montato su 3 ruote**

3 side Fiberglass Players' Rebounder on 3 wheels  
Dimensions: 1,3 x 1,1 m. every side weight 50 Kg.



pg.7



Kg. 50



**Dimensioni: m. 1,3x1,1  
ciascuna faccia  
peso Kg. 50**

Dimensions: 1,3 x 1,1 m.  
every side  
weight 50 Kg.

**Art. 5050**  
**Muro allenamento giocatori a 2 facce di cui una ad inclinazione regolabile, interamente in vetroresina montato su 4 ruote**  
2 side Fiberglass Player's rebounder on 4 wheels  
one side can be inclined

Attraverso l'utilizzo della parete regolabile è possibile determinare traiettorie di risposta della palla verso l'alto al fine di sollecitare il tiro al volo, il colpo di testa ed il controllo di palla  
Thanks to the adjustable inclination you can get an upward ball rebound and train acrobatic shooting, headers and ball control

**Art. MP501N**

**Muro prismatico in vetroresina a 3 facce lisce di dimensioni  
cm.107x140 - cm.107x120 - cm.107x108 - peso Kg.48 - con asole per il trasporto  
\*\*utilizzabile in 4 diverse posizioni\*\***

3 side Fiberglass Players' Rebounder with side dimensions  
107x140 cm. - 107x120 cm. - 107x108 cm. weight 48 Kg. with slots for transport  
**\*\*allows 4 different training positions\*\***

pg.7



Permette di ottenere la più ampia  
varietà di rimbalzi e traiettorie, utili  
per il miglioramento del controllo di  
palla, del passaggio, del tiro a volo  
e del colpo di testa

1

**Posizione "in piedi" con 3 facce  
perpendicolari al terreno di gioco**  
Standing position with all sides  
perpendicular to the ground

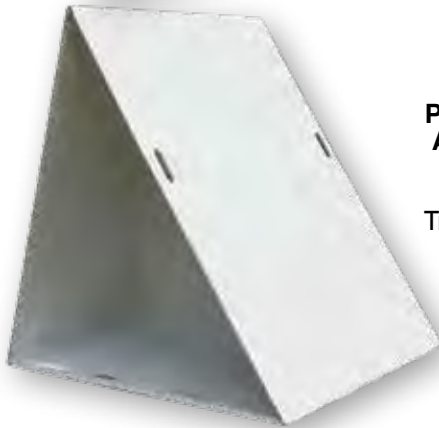

2

**Posizione con base a terra cm.107x108**  
**Allenamento con superfici di rimbalzo  
ad inclinazione alta e medio-alta**  
Position with 107x108 cm. base  
Training with high and medium inclination  
rebounding sides

Allows the widest  
variety of rebounds in  
order to improve ball  
control, passing and  
shooting

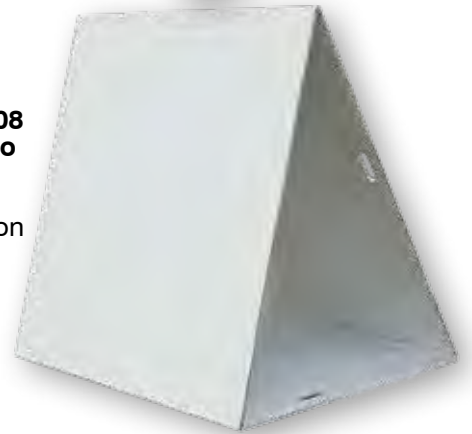

3

**Posizione con base a terra  
cm.107x120**  
**Allenamento con superfici  
di rimbalzo ad  
inclinazione alta e bassa**  
Position with 107x120 cm. base  
Training with high and low  
inclination rebounding sides



**Rinforzo interno  
per l'ottimizzazione del rimbalzo**  
Internal reinforcement for rebound improvement

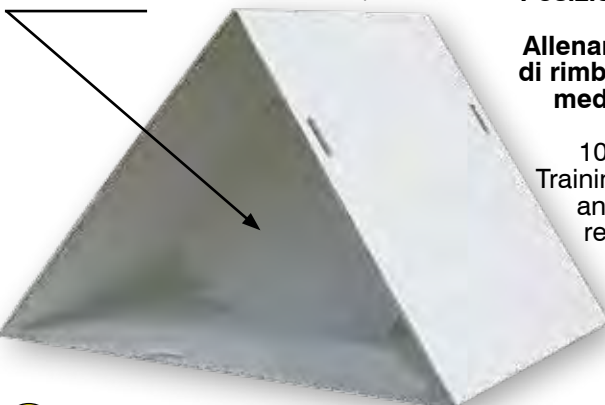

4

**Posizione con base a terra  
cm.107x140**  
**Allenamento con superfici  
di rimbalzo ad inclinazione  
medio-bassa e bassa**  
Position with  
107x140 cm. base  
Training with medium-low  
and low inclination  
rebounding sides

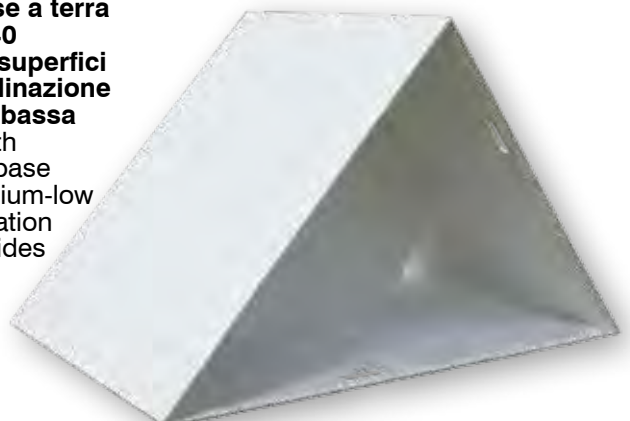

**Art. PLRB16**

**Muro prismatico in vetroresina a 3 facce lisce  
larghezza cm.135 - altezza massima cm.62  
con asole per il trasporto - peso kg.24**

**\*\*utilizzabile contemporaneamente da due lati ed in 3 diverse posizioni\*\***

3 side Fiberglass Players' Rebounder  
width 135 cm. - maximum height 62 cm  
with slots for transport - 24 kg. weight

● pg.7

**\*\*allows 3 different training positions on both sides simultaneously\*\***

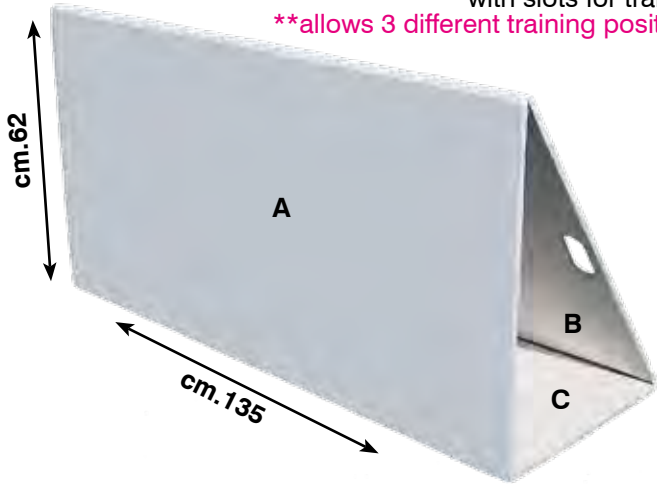

**1**

**Posizione con superficie A perpendicolare al terreno e superficie B molto inclinata**  
Position with 90 degrees A side and high inclination B side

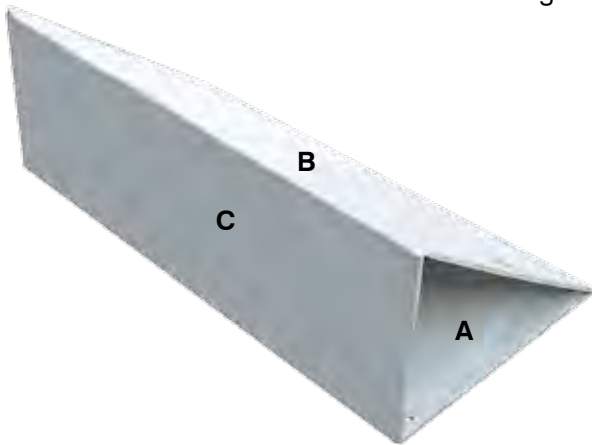
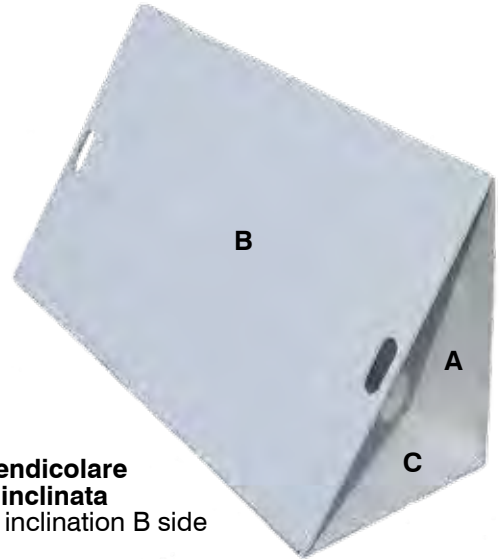

**2**

**Posizione con superficie C perpendicolare al terreno e superficie B inclinata**  
Position with 90 degrees C side and low inclination B side

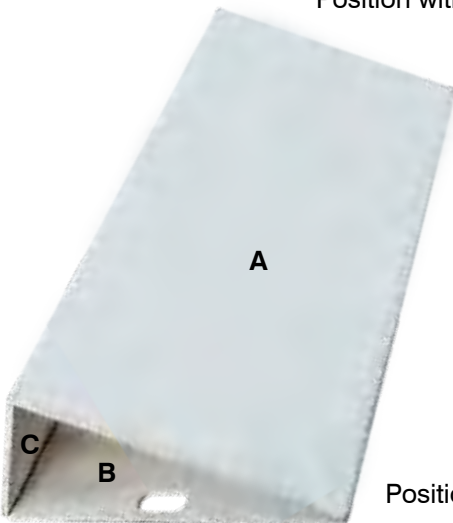
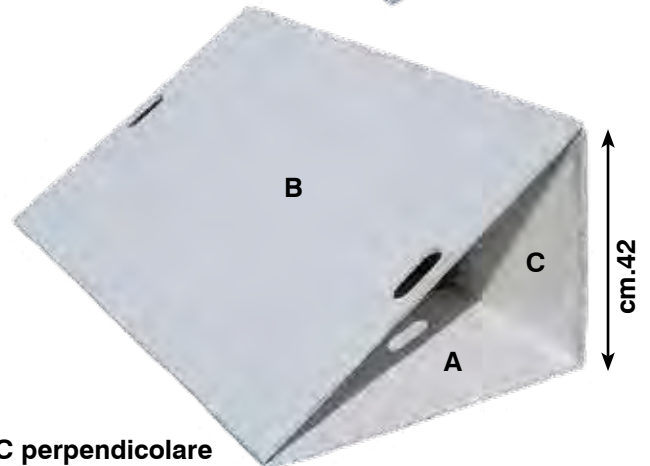

**3**

**Posizione con superfici A e C a diversa inclinazione**  
Position with A and C sides differently inclined

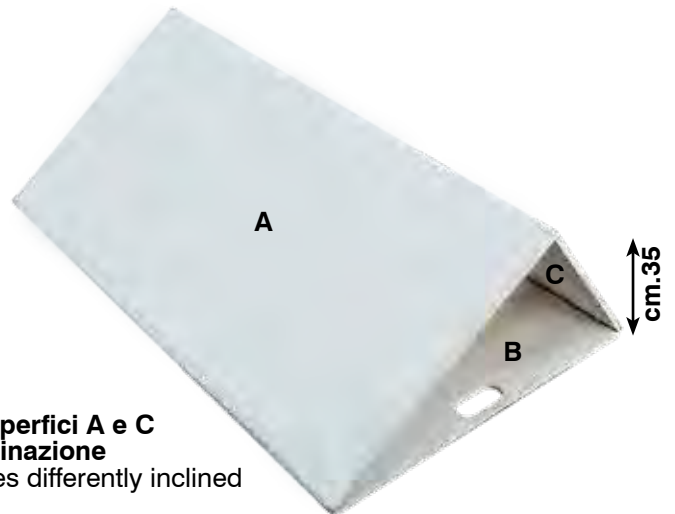

**Permette di ottenere la più ampia varietà di rimbalzi e traiettorie, utili per il miglioramento del controllo di palla, del passaggio, del tiro a volo e del colpo di testa**

**Rinforzo interno per l'ottimizzazione del rimbalzo**  
Internal reinforcement for rebound improvement

**Allows the widest variety of rebounds in order to improve ball control, passing and shooting**

**Art. FRM16**  
**FOOTBALL RAMP - attrezzo in vetroresina per l'allenamento dei riflessi del portiere sui tiri ravvicinati e deviati**  
Football ramp - fiberglass rebounder for GK training to close highly deflected shots



pg.7

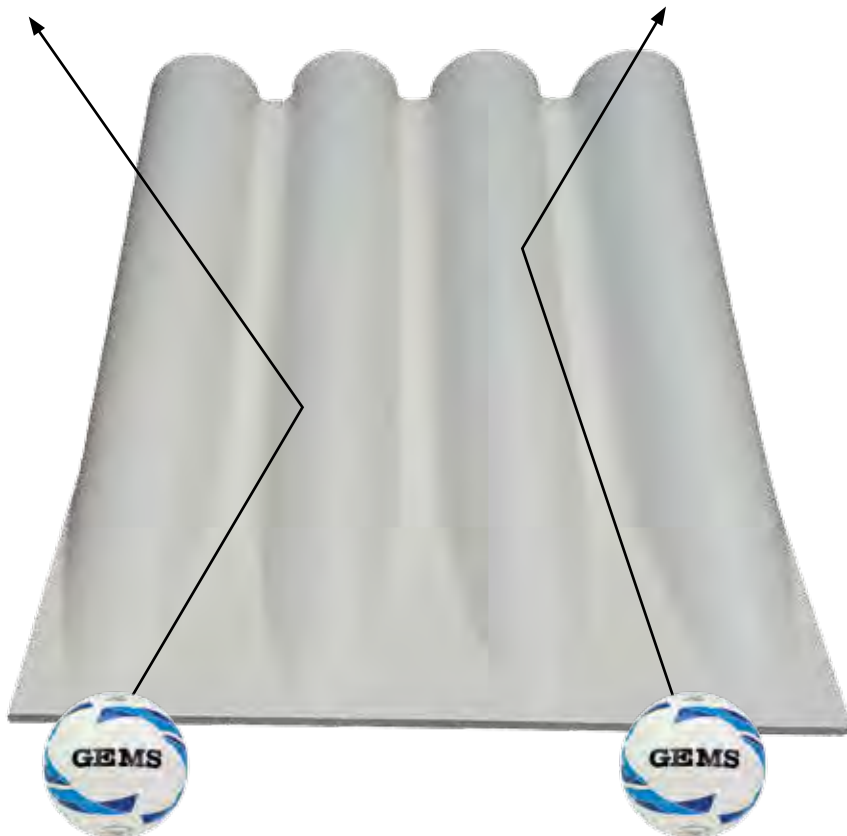

**dimensioni: cm.150x110 ad inclinazione regolabile per mezzo di due montanti telescopici**

dimensions: 150x110 cm. adjustable inclination by means of two telescopic arms

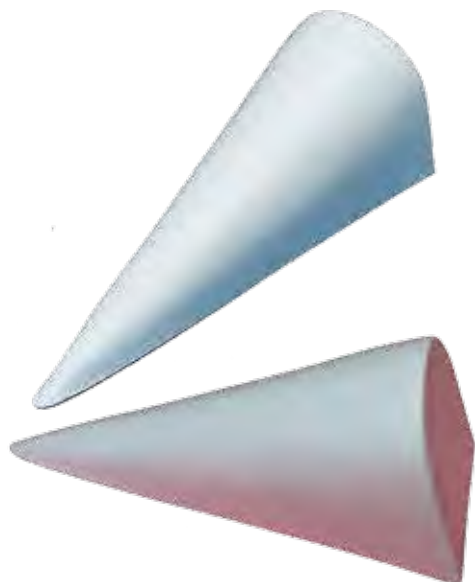

**Art. BDV15**  
**Cuspide in vetroresina appesantito con cemento, dimensioni cm.56x21x21h per allenamento dei riflessi del portiere**  
Fiberglass cusp with concrete filling dimensions 56x21x21 cm. for GK training

pg.7

**Posizionando una serie di cuspidi nell'area piccola si ottengono deviazioni della palla improvvise, utili per l'allenamento dei riflessi e della reattività del portiere**

Train goal keeper's reactivity to sudden and close deflections by placing a number of cusps near the GK's area





**Art. PAL PAL ORIGINAL - Kit 3 pannelli orientabili in legno finlandese trattato a 5 strati rivestiti in gomma, completo di 4 aste metalliche di fissaggio, 6 pomelli di sicurezza e 1 martello per il fissaggio**

Pal Original - Kit 3 rebounding sides in Finnish multi stratum wood covered with rubber, with 4 metal pegs, 6 safety protections and 1 hammer

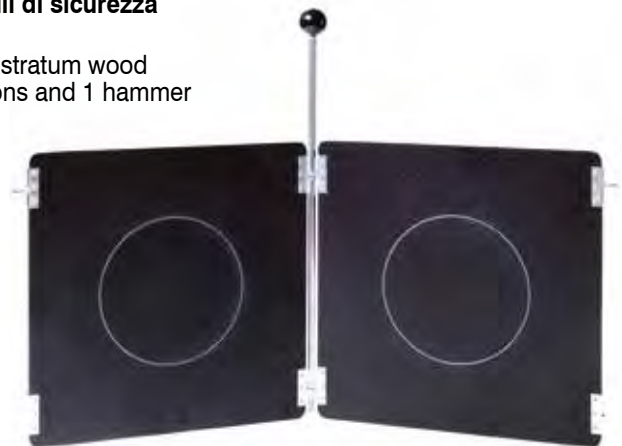
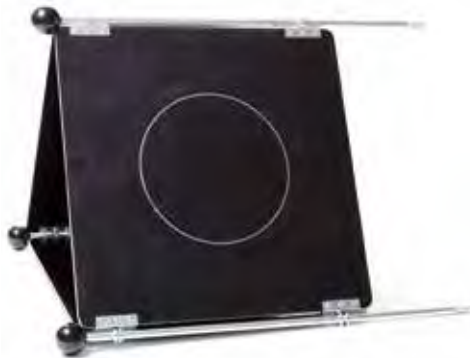

**Ideale per l'effettuazione di esercizi individuali e di gruppo volti al miglioramento della coordinazione motoria, del controllo di palla, del passaggio, del tiro e del gioco aereo**  
Very useful for individual and group exercises to improve coordination, ball control, passing and shooting



**Art. TM001**

**Muro triangolare in legno multistrato marino, trattato con vernice impermeabilizzante dimensioni lato cm.150x50**

**Attraverso l'uso in posizione verticale è possibile determinare traiettorie di risposta della palla verso l'alto al fine di sollecitare il tiro a volo, il colpo di testa e lo stop**

Triangular rebounder made of marine wood treated with special paint against humidity - side size 150x50 cm.

By placing it in vertical position you will receive an upward ball rebound to train acrobatic shooting, header and ball control.

pg.7



**Art. SCVR16**

**Disco in vetroresina con maniglie per l'allenamento della reattività del portiere sulle deviazioni da tiro o colpo di testa ravvicinato diametro cm.47 peso kg.2**

Fiberglass Discus with handles

for close shot and deflection GK training - diameter 47 cm. weight 2 kg.

pg.7



**Art. 5030.T**

**Telaio con rete in alluminio dim. cm.90 x 70 ad inclinazione regolabile con maniglie impugnabili dall'allenatore.**

**Consente la simulazione di colpi di testa e tiri acrobatici per un allenamento alternativo del portiere**

Aluminium frame with net size 90x70 cm. adjustable inclination with handles for trainer to simulate headers and acrobatic shooting trajectories for new GK exercises



**Art. 5035G Telaio con rete cm.105 x 105 in ferro zincato ad inclinazione regolabile, per allenamento portieri e giocatori**

Iron frame with net in galvanized iron dimensions 105x105 cm. adjustable inclination for goal-keepers and players



pg.7

**Art. 503.BF**

**Telaio con rete in ferro verniciato, bifacciale a doppia inclinazione, altezza cm.150 larghezza cm.100 con picchetti per fissaggio a terra, per allenamento portieri e giocatori**

Iron frame with net, in painted iron 2 sides double inclination height 150 cm. width 100 cm. with anchoring hooks for goal-keepers and players

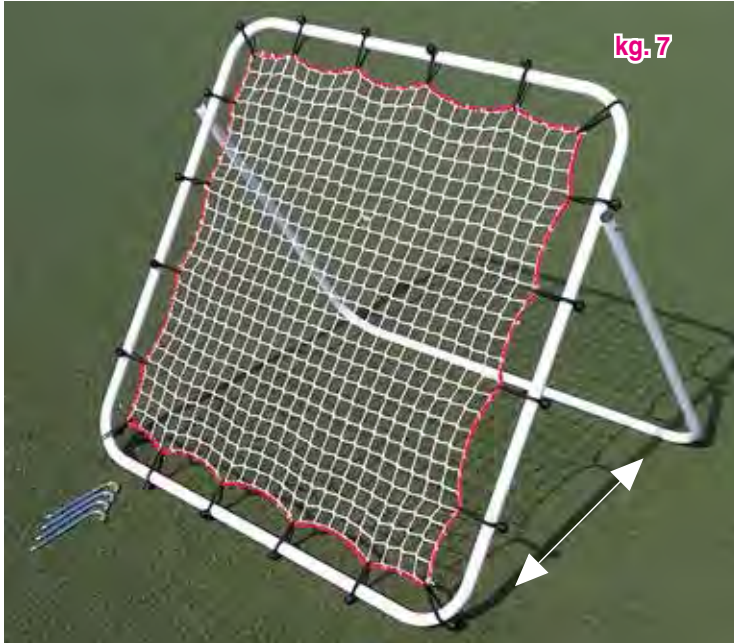

**Art. 5030**

**Telaio con rete cm. 130 x 130  
in ferro verniciato ad  
inclinazione regolabile**

Painted iron frame with net,  
dimensions 130x130 cm.  
adjustable inclination



**con picchetti  
di ancoraggio  
with anchoring  
hooks**

pg. 7

**Art. 5040**  
**Telaio con rete cm. 140 x 140  
in ferro zincato  
ad inclinazione regolabile,  
per allenamento portieri e giocatori**

Iron frame with net in galvanized iron  
dimensions 140x140 cm.  
adjustable inclination  
for goal-keepers and players



**Art. 5041**

**Telaio con rete cm. 315 x 230  
in ferro zincato ad inclinazione  
regolabile, per allenamento  
portieri e giocatori**

Iron frame with net, in galvanized  
iron dimensions 315 x 230 cm.  
adjustable inclination  
for goal-keepers and players



**Art. 4640**

**Coppia ruote gommata per un  
agevole trasporto del telaio  
Art. 5041 (optional)**

Pair of wheels for Art. 5041  
(optional)



Video dimostrativo disponibile su [www.barretsport.com](http://www.barretsport.com)

Video available at [www.barretsport.com](http://www.barretsport.com)

**Art. DT01**  
**Deviatore di traiettoria**  
Pali in alluminio, con cerniere e piedini di stabilità. Coadiuvano l'allenamento quotidiano del portiere ed il suo eventuale recupero post traumatico.

**BREVETTATO**  
DEVIATOR - poles in aluminium, with hinges and stability pegs - very useful to improve GK reactivity and to accelerate injury recovery  
**PATENTED**

**Brevettato**  
**Patented**

pg.7

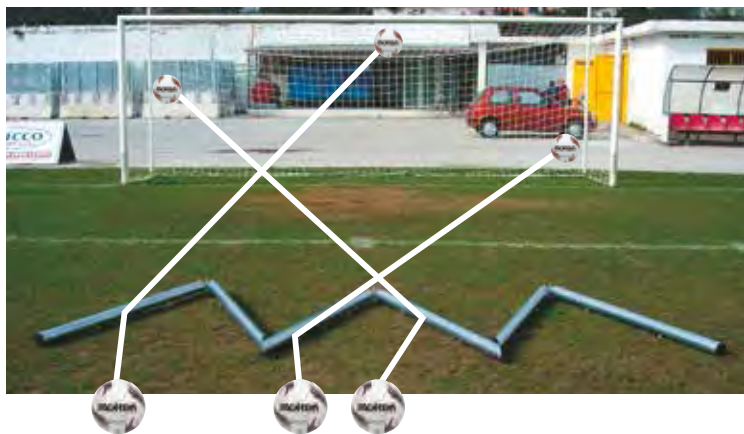

**Borsa per il trasporto inclusa**  
Bag included

Si consiglia di inumidire l'erba di fronte all'attrezzo per incrementare la velocità della palla calciata rasoterra prima dell'impatto con il Deviatore  
We recommend to wet the grass in front of the training device in order to let the ball hit the deviator at a higher speed



Video dimostrativo disponibile su [www.barretsport.com](http://www.barretsport.com)

Video available at [www.barretsport.com](http://www.barretsport.com)

**Art. BP63**  
**BALL PLAYNING** Modello Mundial - telo in PVC con rilievi gonfiabili e riempibili con acqua per l'allenamento dei riflessi del portiere metri 5 x 2,5 - completo di borsa e pompa per il gonfiaggio

Ball Playning Mundial for GK training in PVC size 5 x 2,5 meters with air and water bubbles, complete with pump and bag



pg.7

Prodotto ideato e brevettato da Mario Quagliari, allenatore portieri professionista



Bagnare il Ball Playning prima dell'uso per incrementare la velocità della palla  
Always wet your ball playning to increase ball speed



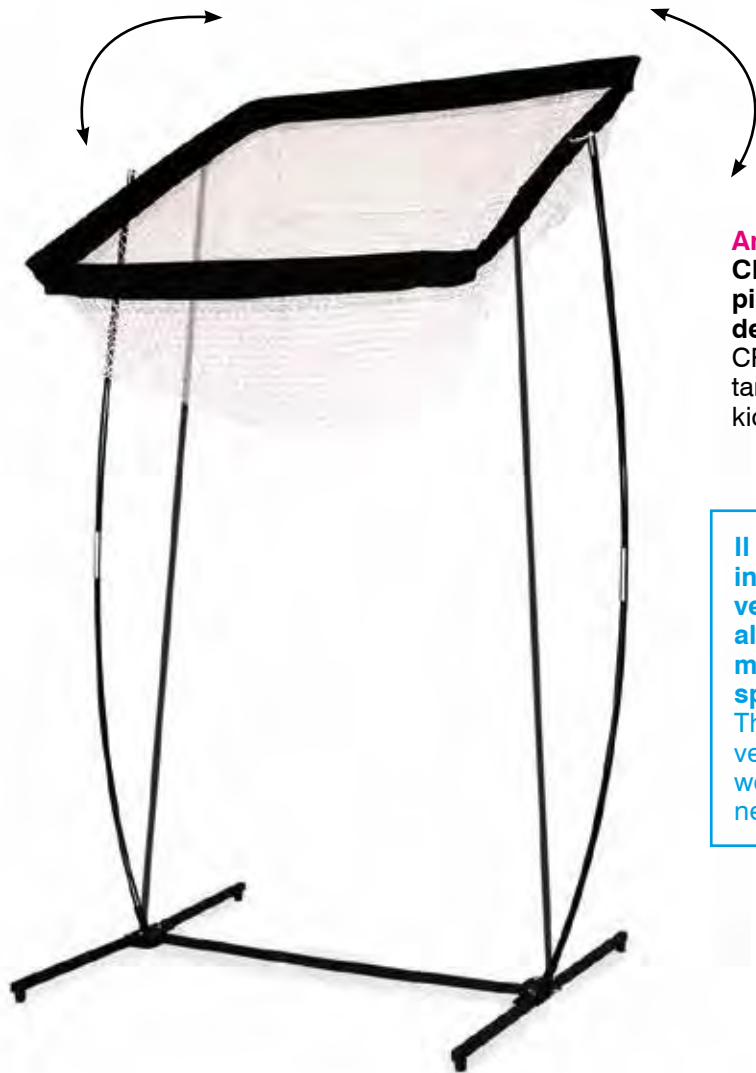

pg.7

**Art. QBF**  
**CROSS TRAINING - rete bersaglio sempre in piedi per allenamento alla precisione del cross, del lancio in profondità, del rinvio del portiere**  
CROSS TRAINING - always standing movable target to improve crossing, long passing and GK kicks precision

**Il bersaglio ha dimensioni cm.120x120, ha una inclinazione regolabile da orizzontale a quasi verticale ed è in grado di ricevere la palla ad altezze comprese tra cm.190 e cm.250 senza mai cadere a terra - peso Kg.10 - facilmente spostabile sul campo**

The basket is adjustable from horizontal to nearly vertical - height adjustable from 190 to 250 cm. weight 10 Kg. - very easy to move on the field, never falls down when hit by the ball

pg.7

**Art. QB5**  
**Rete con bersagli sempre in piedi per allenamento alla precisione dei tiri e dei passaggi dei bambini delle scuole calcio**  
Net with 5 targets - always standing movable device to improve soccer school kids' precision shooting and ball passing

**La rete ha dimensioni cm.240x240 ed un peso di Kg.13 - facilmente spostabile sul campo, impossibile da abbattere a terra**

Net dimensions 240x240 cm. weight 13 Kg. very easy to move on the field, never falls down when hit by ball

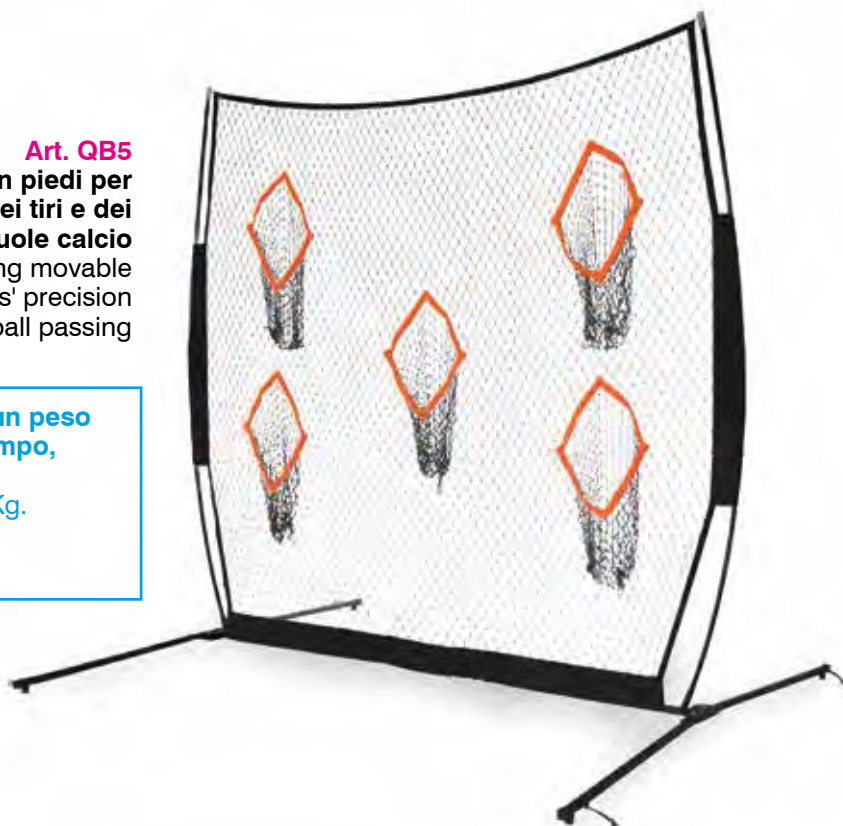

## PROPRIOCEZIONE - Equilibrium training



**Art. 168PC**  
**Tavoletta propriocettiva in plastica su emisfera, Ø cm. 41 regolabile in altezza**  
 Plastic Equilibrium Board with hemisphere bottom side Ø 41 cm. adjustable height



**Art. IS441**  
**Tavoletta propriocettiva in legno su emisfera, con rivestimento antiscivolo Ø cm. 40**  
 Wooden Equilibrium Board with hemisphere bottom side, Ø 40 cm. base with anti-skid surface

pg.8

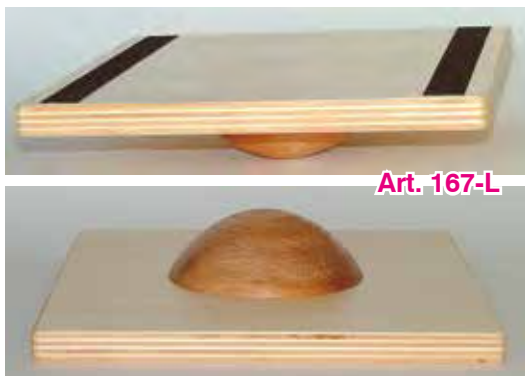

**Art. 167-L**  
**Tavoletta propriocettiva in legno su emisfera, base di appoggio cm. 30x30**  
 Wooden Equilibrium Board with hemisphere bottom side, base 30x30 cm.

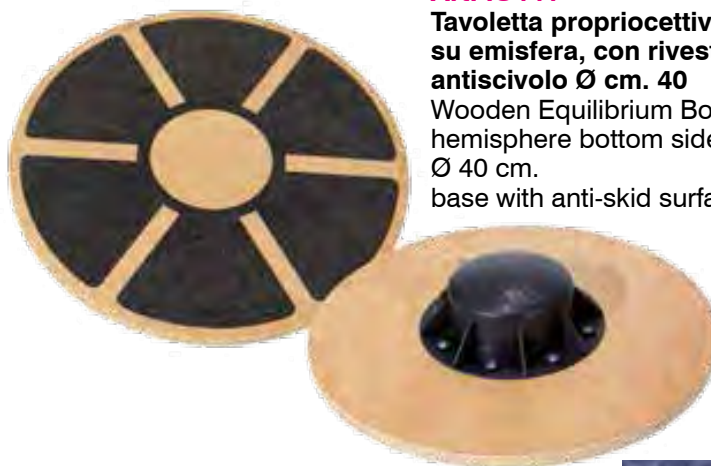

**Art. 169-R**  
**Tavoletta propriocettiva in legno su semiluna, base di appoggio cm.60x40 con rivestimento in gomma antiscivolo**  
 Wooden Equilibrium Board, with half moon bottom side, base dimensions cm.60x40 with anti-skid surface



**Art. 167-T**  
**Tavoletta propriocettiva in legno su emisfera, Ø base di appoggio cm. 60 con rivestimento in gomma antiscivolo**  
 Wooden Equilibrium Board with hemisphere bottom side, base Ø 60 cm. with anti-skid surface



**Art. 169-V**  
**Tavoletta propriocettiva in vetroresina su semiluna, base di appoggio cm.60x40**  
 Fiberglass Equilibrium Board, with half moon bottom side, base dimensions 60x40 cm.



**Art. 167-V**  
**Tavoletta propriocettiva in vetroresina su emisfera, Ø base di appoggio cm. 60**  
 Fiberglass Equilibrium Board with hemisphere bottom side, base Ø 60 cm.



**Art. 995201** **PROPRIO FOOT**  
Tavoletta propriocettiva in legno situata su una superficie di appoggio gonfiabile  
Wooden Equilibrium Board with inflatable bottom side



**Art. 995212** **SOMBRERO**  
Tavoletta per ginnastica e riabilitazione che combina l'instabilità dell'imbottitura in gommapiuma sul piano di appoggio in legno con le proprietà di una semisfera gonfiabile  
Wooden Equilibrium Board with foam rubber on top and inflatable hemisphere on bottom side

pg.8



**Art. 995243** **ROLA BOLA** Tavola per l'allenamento dell'equilibrio con superficie antiscivolo - i fermi di sicurezza impediscono al cilindro di scivolare all'esterno  
Wooden Equilibrium Board with anti-skid on top  
The cylinder never slips out of the board thanks to the security wood pieces on bottom side



**Art. TBEFS**  
**BLOCCO PER STRETCHING** tendineo e muscolare (flessori caviglia e coscia, dorso etc.) con appoggio soffice e sagomato a 2 inclinazioni ideale per il defaticamento e per il recupero  
STRETCHING BLOCK for ankle, leg, back muscles and tendons - with soft double inclination very good for after-training exercises



**Art. AIR.OC**  
Air step gonfiabile completo di maniglie con elastici  
Inflatable Air Step handles and elastics included





**Art. MH9T / MH16T** Semisfera gonfiabile Trial per riabilitazione e stimolazione propriocettiva diam. cm. 9 o cm. 16  
Inflatable hemisphere for rehabilitation Ø 9 or 16 cm.



pg.8



**Art. FTN-DB**  
Cuscino gonfiabile puntinato Ø cm 32,5  
Inflatable cylinder for rehabilitation Ø cm 32,5



**Art. FY8911**  
Cuscino gonfiabile puntinato Ø cm 39  
Inflatable cylinder for rehabilitation Ø cm 39



**Art. C1**  
Pedana Cilindrica gonfiabile Trial Skimmy per riabilitazione e stimolazione propriocettiva dim. cm.32,5x6  
Inflatable cylinder for rehabilitation dim. 32,5x6 cm.

pg.8



**Art. C2**  
Pedana Cilindrica gonfiabile Trial Super Skimmy per riabilitazione e stimolazione propriocettiva, dim. cm.40x9  
Inflatable cylinder for rehabilitation dim. 40x9 cm.



**Resistenti ai tacchetti**  
Stud proof



**Art. C3**  
Pedana Trial Super Skimmy Professional con spalla rinforzata per riabilitazione e stimolazione propriocettiva, gonfiabile cm.40x9  
Inflatable cylinder 40x9 cm. reinforced on sides







**Art. C11**  
**Pedana Rotante 1**  
 dim. cm 32,5x6  
 kg 2,3  
 (inclusa pompetta  
 per il gonfiaggio)  
 Rotatory disk 1  
 pump included



**Art. C22**  
**Pedana Rotante 2**  
 dim. cm 40x10  
 kg 4  
 (inclusa pompetta  
 per il gonfiaggio)  
 Rotatory disk 2  
 pump included



**Le Pedane Rotanti Trial, grazie al particolare meccanismo rotante, consentono di creare un'infinita varietà di esercizi basati su diverse posizioni di appoggio e modalità di movimento, utili a stimolare contemporaneamente il sistema vestibolare e quello visivo sensoriale, agendo quindi su tutti i sistemi di controllo del movimento sia a livello nervoso centrale che su quello spinale medio e periferico**

Rotatory Proprioceptive Disks Trial, given the particular rotating mechanism, allow a great variety of exercises based on different positions and motions, useful to simultaneously stimulate the vestibular and the sensory visual systems at both central and spinal/peripheral nervous levels

pg.8

**Art. C4**  
**Rebound Disk - diametro cm.40**  
**altezza cm.4 - Kg.1,5 colore rosso**  
 40 cm. diameter - 4 cm. thick - 1,5 Kg.



**Rebound Disk Trial è una nuova pedana ideale per allenare contemporaneamente la forza muscolare e la proprioccezione. È adatta sia all'uso indoor che outdoor, anche con scarpe tecniche munite di tacchetti. In particolare, con Rebound Disk è possibile sfruttare l'altezza per effettuare esercizi combinati pliometrici (cadute ed ammortizzamento con e senza rimbalzo) e propriocettivi, consentendo all'utente un'esperienza coordinativa e di potenziamento neuromuscolare notevole. Il salto, così come la corsa, è un elemento fondamentale in moltissimi sport come calcio, pallamano, beach-handball, basket, volley, e Rebound Disk è particolarmente allenante per il salto con arresto e cambio di direzione**

Rebound Disk Trial is a new tool ideal to simultaneously train muscle strength and proprioception.

It's suitable both for indoor and outdoor utilization, even with technical shoes (with studs).

In particular, with Rebound Disk it's possible to exploit one's height for plyometric exercises (fall and dampen with or without rebound) and for proprioceptive ones, and the user is enabled to experience a remarkable coordination and neuromuscular strengthening. Jumping, as well as running, is a basic element in many sports such as soccer, handball, beach-handball, basketball, volleyball, and Rebound Disk is very effective in training jump with stop and direction changes

**Art. T1 Medusa Trial - struttura instabile base Ø cm. 45  
altezza cm. 23 per riabilitazione e stimolazione  
equilibrio, in gomma doppio strato  
massima instabilità**

Medusa for rehabilitation  
and equilibrium training  
double stratum rubber  
Ø 45 cm. base  
height 23 cm.

**Resistente  
ai tacchetti  
Stud proof**



pg.8



**Resistente ai  
tacchetti  
Stud proof**

**Art. T3  
Pedana instabile  
con base inferiore  
antiscivolo**

Ø cm. 55  
altezza cm. 15  
studiata per  
i campi sintetici,  
specifica per  
i più giovani  
Unstable Medusa  
with anti-skid bottom  
55 cm. Ø base  
height 15 cm.  
ideal for artificial  
grass and young  
players



pg.8



**Art. T1.1  
Medusa Trial Ø cm.45  
altezza cm. 23  
con piatto rigido  
alla base  
per conferire  
maggiore stabilità**  
Medusa 45 cm. Ø base  
height 23 cm.  
with rigid bottom for  
better stability

**Resistente  
ai tacchetti  
Stud proof**



**Nuova maniglia  
New handle**



pg.8



**Art. T2 Tartaruga Trial - struttura instabile base Ø cm. 65 altezza cm. 24  
per riabilitazione e stimolazione equilibrio, in gomma doppio strato**  
Medusa double stratum rubber Ø 65 cm. base height 24 cm. - for rehabilitation and equilibrium training

**New!**



pg.8

**Art. AHF-127**

**Pedana BOSU**

Ø cm.58 con tiranti elastici e maniglie completa di pompa per il gonfiaggio

Bosu ball Ø 58 cm. with handles and elastic straps, pump included



**Art. TCRAZY / TCR.T2**  
**CRAZY HORSE per allenamento di equilibrio "estremo" da effettuarsi in coppia**  
 For Extreme balance training

**New!**



**Art. SH40**

Innovativa STRUTTURA AUTOPORTANTE di 4 metri di lunghezza per l'allenamento dell'equilibrio, che permette di fissare la fettuccia a due altezze: cm. 30 oppure cm. 50. Grazie ad un comodo pianale in legno permette all'utente di posizionarsi nel modo migliore prima di iniziare ad utilizzare la fettuccia. Perfetta per palestre, scuole ed uso domestico. Fettuccia inclusa.

New slackline structure for balance training, 4 meter long, 2 possible heights to select: 30 or 50 cm. With a solid wood step you can stay on, comfortable and calm, before starting your walk. Best for gyms, schools or just at home. Slackline included.

**Art. TA-I Coppia tappeti propriocettivi a isole a 2 densità diverse:**

**1 tappeto a densità 120 gr. con isole densità 30 gr. - 1 tappeto densità 30 gr. con isole densità 120 gr. dimensioni tappeti m.2x1 modulabili con velcro (a formare 1 materasso m.4x1 o m.2x2)**

Pair of Mats 2x1 meter each (when together 4x1 or 2x2 meter) :

1 mat 120 gr. density with 30 gr. density round areas; 1 mat 30 gr. density with 120 gr. density round areas

pg.8

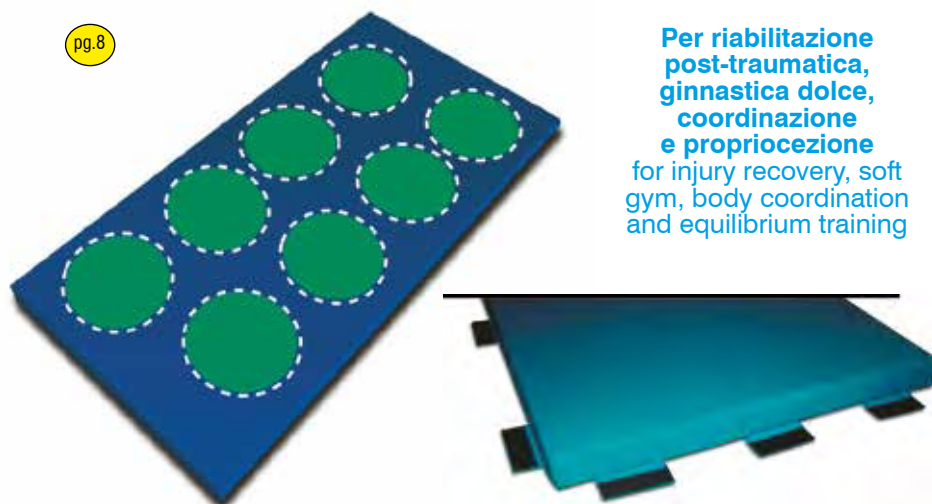

**Per riabilitazione post-traumatica, ginnastica dolce, coordinazione e propriocezione**  
 for injury recovery, soft gym, body coordination and equilibrium training





pg.10

**Art. V9178**

**Plinto per pliometria regolabile in altezza da cm. 30 a cm. 45 in tubolare di acciaio zincato piano di appoggio in legno multistrato dim. cm.150x30**  
Plyometric bench adjustable heights (from 30 to 45 cm.) in galvanized steel wooden board dim. 150x30 cm.

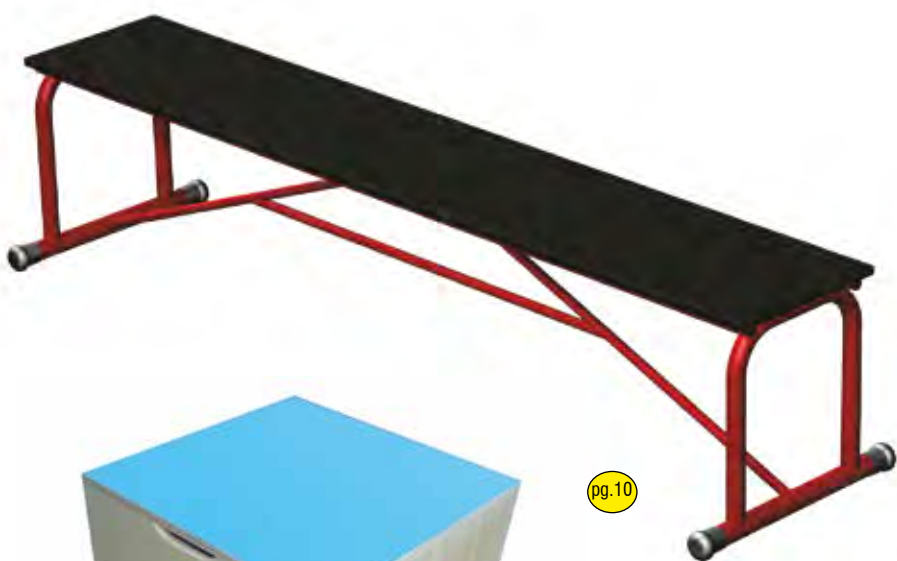

**Art. 1PP40/2PP40/3PP40  
1PP50/2PP50/3PP50**

**Panca per pliometria in acciaio verniciato, lunghezze disponibili: cm. 100 / cm. 200 / cm. 300 larghezza cm. 35 altezze disponibili: cm. 40 / cm. 50 piano di appoggio in legno rivestito in gomma antiscivolo**  
Plyometric bench in painted steel, available length 100 / 200 / 300 cm. width 35 cm. available height 40 / 50 cm. board made of wood with anti-skid rubber cover



**Art. VCU60/VCU70/VCU80**

**Cubo per pliometria in legno verniciato al naturale con gomma antiscivolo sui piani di appoggio lato cm.60/70/80**  
Wooden plyometric cube with anti-skid rubber - 60/70/80 cm. side



**Art. PAV2 Set 3 plinti soft a basi rettangolari, sovrapponibili - 3 altezze ottenibili: cm. 30, 60, 90 in gommapiuma rivestita con PVC ignifugo Cl. 1**  
Set of 3 rectangular base soft steps - by placing them one upon the other you can get 3 different heights: 30, 60, 90 cm.

**TRAMPOLINI - CERCHI - CORDE - BASTONI - Trampolines - Hoops - Cords - Sticks**



**Art. 166**  
Trampolino elastico  
Ø cm. 97  
Trampoline  
Ø 97 cm.

**Art. V1709**  
Trampolino elastico  
ad altezza fissa  
dim. cm.125x125  
Trampoline 125x125 cm.  
reinforced



**Art. S01154**  
Trampolino elastico  
ad inclinazione  
regolabile  
completo di protezioni  
dim. cm. 125x125  
Trampoline  
size 125 x 125 cm.  
adjustable inclination  
with soft perimetric  
protection

**Art. TRO-9**  
Trampolino da esterno Ø cm. 305  
con rete di protezione perimetrale  
Outdoor trampoline cm. 305 diameter  
with perimetric protection net



pg.8

## SCALE - CERCHI - CORDE - Speed Ladders - Hoops - Jumping Ropes

pg.10

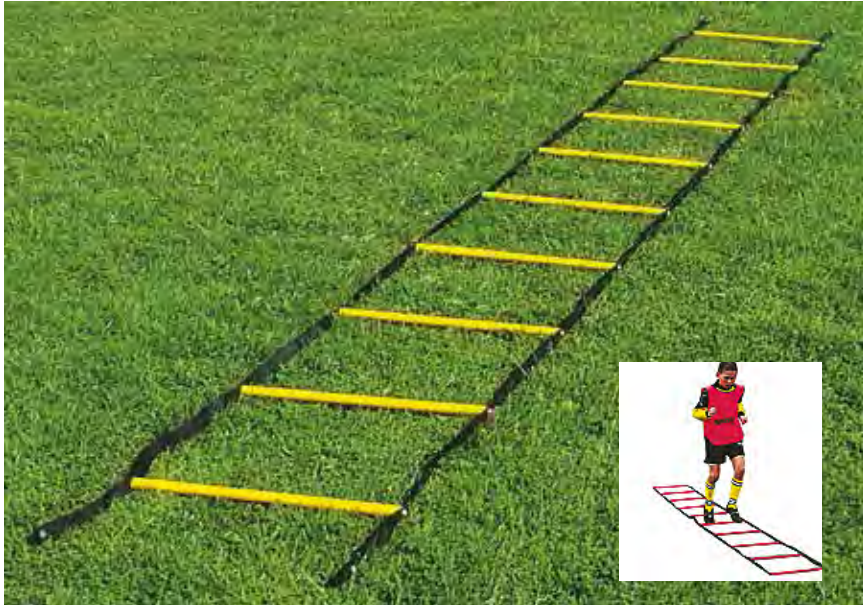

**Art. SL4**  
**Scala lunghezza m. 4 con 10 pioli rotondi per esercizi di coordinazione motoria (compresa sacca per il trasporto)**  
Speed ladder length 4 meters with 10 tubular rungs for quick step and coordination exercises, bag included



**Art. SL6**  
**Scala lunghezza m. 6 con 12 listelli piatti a distanza regolabile (compresa sacca per il trasporto)**  
Speed ladder length 6 meters with 12 adjustable flat rungs, bag included



**Art. 708228**  
**Scaletta componibile a 10 listelli**  
10 bar multiform speed ladder

**Art. 708241**

**Scala in plastica flessibile lunghezza m.4  
con 10 pioli spessore cm.1,5  
dimensione quadri cm.40x40  
pieghevole con rimessaggio**

Flexible speed ladder length 4 meters  
in plastic pipes 1,5 cm.  
thick - foldable with holder



pg.10

**Art. 701411**

**Minibirillo  
concavo altezza cm. 9  
per sollevamento  
scala Art. 708241  
Cone 9 cm.  
height carved on top  
for Art. 708241  
underneath support**



**Art. K4111**

**Kit scala Art. 708241 + 20 Minibirilli Art. 701411  
Kit Art. 708241 + 20 x Art. 701411**



pg.10

**Art. 995215**

**Cor Web da 36 quadri cm. 35x35  
dimensioni totali cm. 465x210  
composto da 13 stecche gialle semirigide  
e 4 strisce in cinghia rossa  
Speed ladder 36 squares 35x35 cm. each  
overall dimensions 465x210 cm.**

**Art. 995216**

**Borsa per Cor Web in nylon con cordoncino e  
stopper per chiusura, con maniglia per il trasporto  
Bag for Cor Web 36 squares**

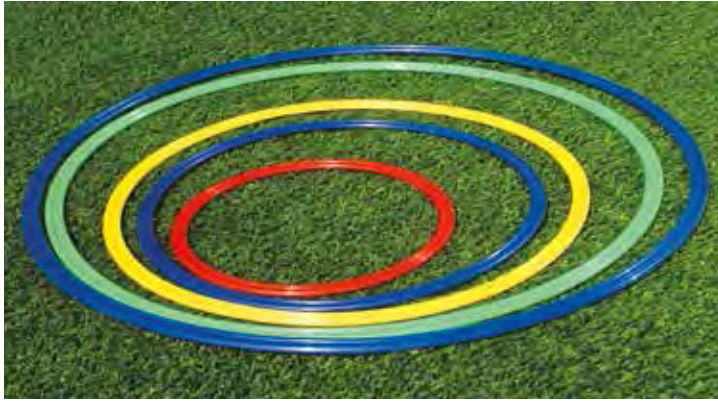

**Art. CNP30 / CNP40 / CNP50 / P00181 / P00191 / P00201**  
**Cerchio in nylon piatto Ø cm. 30 / 40 / 50 / 60 / 70 / 80**  
 Flat Nylon Hoop Ø 30 / 40 / 50 / 60 / 70 / 80 cm.



**Art. P00182 / P00192 / P00202 / P00212**  
**Cerchio in PVC tubolare**  
 Ø cm. 60 / 70 / 80 / 90  
 Tubular PVC hoop  
 Ø 60 / 70 / 80 / 90 cm.



**Art. S00402/S00405/  
 S00406/E21**  
**Bastone in legno o  
 PVC cm. 80 - 100 - 120**  
 Wooden and PVC Stick  
 80 - 100 - 120 cm.



**Art. OCC11**  
**Connettore per  
 cerchi piatti**  
 Flat Hoop Connector



**Art. S00472**  
**Mensola porta  
 cerchi a parete  
 in acciaio  
 verniciato**  
 Hoop wall Holder  
 in painted steel



**Art. S00414**  
**Mensola porta bastoni a parete  
 in acciaio verniciato**  
 Stick wall Holder in painted steel

 pg.9



**Art. 043**  
**Corda per salto in canapa con manici  
 in legno ed ingrossamento centrale**  
 Hemp Skipping Rope with hardwood  
 handles, thicker in the middle section



**Art. 043P**  
**Corda per salto in nylon  
 con manici in legno**  
 Nylon Skipping Rope with  
 hardwood handles



**Art. AHF-017**  
**Corda per salto in PVC  
 con manici soft touch  
 e cuscinetti a sfera**  
 PVC Skipping Rope  
 with soft handles  
 and ball bearings



**Art. CS1**  
**Corda per salto in canapa con ingrossamento  
 centrale (senza manici)**  
 Hemp Skipping Rope thicker in the middle without handles



**Art. 043L** Corda per  
 salto in pelle  
 Leather Skipping Rope  
 with hardwood handles





**Art. STAR**

**Starkick completo di cintura e corda elastica per allenamento ai palleggi ed al tocco di palla (pallone escluso)**

Starkick with belt and elastic rope for ball kick and control training (ball not included)

pg.10



**Art. OTK**

**Training Kicker con corda non elastica per allenamento ai palleggi ed al tocco di palla (pallone escluso)**

Training Kicker with non elastic rope for ball kick and control training (ball not included)



**Art. TIM-SP**

**Supporto per Tackle improver**  
Holder for Tackle improver

**Art. TIM**

**Tackle improver per allenamento al contrasto**  
For tackle training

Uno strumento innovativo per migliorare la tecnica di esecuzione e la potenza del contrasto. Il Tacke Improver indirizza il piede d'appoggio verso la posizione più idonea per esprimere la maggiore potenza d'impatto. Potenzia inoltre tutte le catene muscolari che intervengono nel contrasto, ma senza causare traumi, grazie ad una speciale molla collegata al pistone che sorregge il pallone.

*Very useful training device for strengthening all muscles involved in tackling. Absolutely safe, thanks to a spring and piston system that avoids injuries.*



pg.10



**Art. CVCO**

**Cavigliera Coordinativa con contrappeso, migliora l'equilibrio e l'indipendenza psicomotoria delle gambe, ed in particolare ammorbidisce la gamba dominante migliorandone la sensibilità del piede**

Rotating ankle, with weight, to improve equilibrium and leg independence: in particular it softens the dominant leg improving sensibility of the non dominant foot



pg.10

## ALLENAMENTO SOTTO CARICO - Training with weights



Art. SLD



Art. ASN  
Cintura in pelle sintetica con velcro completa di corda e moschettoni di ricambio per slitta Art. SLD  
Synthetic leather belt, rope and chains spare for Art. SLD

Art. SLD Slitta per il miglioramento della capacità di accelerazione tramite il traino a carico variabile completa di cintura in pelle sintetica con velcro, corda e moschettoni (dischi in ghisa non inclusi)  
Sledge (weights not included) improving acceleration with synthetic leather belt, rope and chains

Art. CBV  
Cintura in pelle sintetica con velcro di ricambio per Art. SLD  
Synthetic leather belt w/velcro spare for Art. SLD



pg.9



Art. PCH  
Paracadute per potenziamento della corsa  
Parachute to improve the power of your run



Art. V5083  
Pedana di salto in tubo in acciaio dim. cm. 100x100 con elastico rigido a tensionamento uniforme e dinamometro, cintura e moschettoni (dischi in ghisa non inclusi)  
Jump Platform in painted steel dim. 100x100 cm. with elastic rope and dynamometer, belt and snap-hooks (weights not included)

Art. 045  
Giubbino caricabile con pesi fino a Kg.10 (pesi inclusi)  
Jacket Weighted up to 10 Kg. (weights included)



pg.9



pg.9

**Art. 991310/991311/991312**  
**Shoulder Bag con 3 maniglie**  
**pesi disponibili Kg. 10/15/20**  
Shoulder Bag with 3 handles  
weights available 10/15/20 Kg.



**Art. FBG-5/FBG-10/FBG-15/FBG-20/FBG-25**  
**BORSA ZAVORRATA**  
**con 6 impugnature**  
**pesi disponibili Kg.5-10-15-20-25**  
HEAVY BAG with 6 handles  
weights available 5-10-15-20-25 Kg.

pg.9

**Art. BGZ**  
**BORSA GONFIABILE** zavorrata con acqua (a peso variabile)  
cm. 85 con 4 maniglie - consente nuovi esercizi di forza  
coordinata grazie alla massa oscillante interna  
INFLATABLE BAG with water inside, length cm. 85 with 4 handles  
allows new exercises for muscle strength thanks to the dynamic  
weight inside



**Art. BR-3812 / BR-5015**  
**Fune da allenamento**  
**Battle Rope**  
ø mm 38 lunghezza mt. 12  
oppure  
ø mm 50 lunghezza mt. 15  
Battle Rope  
12 meters - 38 mm. thick or  
15 meters - 50 mm. thick

pg.9



**New!**

**In poliestere intrecciato con impugnature rivestite in gomma termoretraibile**  
**ideale per il potenziamento dei muscoli di spalle e avambracci,**  
**ottimo allenamento cardiorespiratorio**  
Polyester encased rope with shrink-wrap handles, perfect for strengthening shoulders  
and forearm muscles, excellent cardio-respiratory workout



pg.11

**Art. 995238V/995239V/995240V**  
**Barra in alluminio**  
**con bande elastiche**  
**gialle (soft)/blu (medium)**  
**verdi (hard)**  
**impugnature in neoprene**  
**e maniglie morbide**  
Aluminium Bar with yellow (soft)/blue  
(medium)/green (hard) elastic bands,  
neoprene soft handles

## FUNCTIONAL TRAINING



### FT.IST

**Functional training. Attrezzo polifunzionale per il potenziamento della catena**

**estensoria e flessoria degli arti superiori e inferiori**

Functional training multi-purpose belt for the enhancement of the extension and flexion muscular chains of the upper and lower limbs



### MTLTX

**Lacci di Trazione**  
Traction Laces

pg.11



### PLTRZ

**Prolunga per Lacci di Trazione**  
Extension for Traction Laces



**Attrezzo polifunzionale per il potenziamento della catena estensoria e flessoria degli arti superiori e inferiori**  
Multi-purpose belt for the enhancement of the extension and flexion muscular chains of the upper and lower limbs



### Art. DTL15

**Lacci di Trazione dinamici con carrucola**

Dynamic functional training with pulley

## BANDE ELASTICHE - BOA - Elastic Bands

**New!**



**Art. IFBG**  
Fitness band colore giallo  
yellow  
cm. 175x15

**Art. IFBR**  
Fitness band colore rosso  
red  
cm. 175x15

**Art. IFBB**  
Fitness band colore blu  
blue  
cm. 175x15

**Art. IFBN**  
Fitness band colore nero  
black  
cm. 175x15



pg.11

**Art. 991707/ 991708/ 991709**  
**SET 10 ELASTICI AD ANELLO**  
colore giallo (morbido) - rosso (medio)  
verde (resistente) Ø cm. 27,50  
Elastic Rings yellow (soft) - red (medium)  
green (hard) 27,5 cm. Ø



**New!**

pg.12

**Art. AHF-128/AHF-129/AHF-130/AHF-131/AHF-132**  
**Elastico ad anello POWER BAND**

Ø mm. 2080x4,5 spessore  
rosso h. mm. 13 - nero h. mm. 22  
viola h. mm. 29 - verde h. mm. 45  
blu h. mm. 64

Power Band elastic Ø mm.2080x4,5 thick  
red 13 mm. height - black 22 mm. height  
violet 29 mm. height - green 45 mm. height  
blue 64 mm. height



**Art. 991710/ ... /991742**  
**Elastico tubing con  
e senza maniglie**  
colore rosso, giallo, viola, nero  
Elastic with and without handles  
red, yellow, violet, black color



pg.11

**Art. RLEF**  
**Rotolo lattice fucsia  
per esercizi muscolari,**  
larghezza cm. 15,  
lunghezza m. 25  
spessore 0,3 mm.  
Elastic fuchsia Band  
for muscle exercises,  
15 cm. wide,  
25 meter long,  
0,3 mm. thick



**Art. RLEG**  
**Rotolo lattice giallo  
per esercizi muscolari,**  
larghezza cm. 15,  
lunghezza m. 25  
spessore 0,5 mm.  
Elastic yellow Band  
for muscle exercises,  
15 cm. wide,  
25 meter long,  
0,5 mm. thick

**Art. AHF-068**  
**Set 3 elastici tubing con maniglie  
tre differenti livelli di resistenza  
impugnature ergonomiche soft touch  
per esercizi arti superiori e inferiori  
completo di borsa in microrete**  
Set 3 elastics with handles  
3-level resistance - soft touch handles,  
bag included - tones and strengthens  
arms, legs, gluteus, abdominals,  
shoulders and chest muscles

pg.11





**Art. AE**  
**Banda elastica**  
**Antonelast**  
**per esercizi di**  
**stretching e**  
**potenziamento**  
**muscolare**

Elastic band for  
 body muscle  
 exercises



Con velcro cucito su  
 entrambe le estremità  
 with velcro seamed at  
 both sides



**Art. RA**  
**Rinforza abduttori**

Elastic band  
 for abductor muscles

Con velcro cucito su  
 entrambe le estremità  
 with velcro seamed at  
 both sides



pg.11



**Art. OSI**

**Over Speed Improver - Tramite questa cintura elastica l'atleta più veloce trascina il più lento,**  
**incrementando contemporaneamente la velocità di entrambi**

By this elastic belt the quicker player pulls the slower player, increasing both athletes' speed



Con velcro cucito su  
 entrambe le estremità  
 with velcro seamed at  
 both sides



**Art. PSR**  
**Power Speed**  
**Resistor**  
**per potenziamento**  
**della corsa**  
**esercizio in coppia**  
**(nylon non elastico)**  
 To improve explosive  
 force - two people  
 involved (non elastic  
 band)

pg.11



**Art. EPW**  
**Elastic Power**  
**2 fasce con cintura**  
**in pelle**  
**incrementa**  
**la forza esplosiva**  
**potenziando la**  
**muscolatura delle**  
**gambe e del dorso**  
 2 Bands with leather belt  
 for explosive strenght  
 improvement, for leg and  
 back muscle training



**Art. SRE**  
**Speed Reaction**  
 Allenamento dei riflessi e della reattività  
 (l'elastico non si sgancia se il difensore perde contatto dall'attaccante)  
 Reflex and reactivity training device (the belt does not separate if the defender loses contact)

**Cintura elastica**  
 Elastic belt



**Cintura non elastica**  
 Non elastic belt

● pg.11

**Art. EB**  
**Evasion Belt - Allenamento dei riflessi e della reattività ideale per marcature a uomo**  
 (la cintura si sgancia se il difensore perde contatto dall'attaccante)  
 Reflex and reactivity training device, for man to man coverage (the defender loses contact)



**Art. RIM**  
**Reaction Improver**  
 per l'allenamento della reazione allo stimolo visivo in percorsi ad ostacoli, ideale per marcature a uomo  
 (l'elastico si stacca se si perde contatto)  
 Elastic Belt for visual reflex training in drill sections, for man to man coverage (the elastic separates if following athlete loses contact)



**Art. KAP Kit allenamento portiere** Goal-Keeper training Kit, **composto da: 10 Antonelast, 1 Cintura, 1 Rinforza abduttori, 4 Anelli fissa bande** made of 10 Antonelast, 1 Belt, 1 Abductor muscle band, 4 connecting rings - **per il miglioramento della forza esplosiva** to improve explosive muscular strength and goal keeper's jumps and dives

● pg.11



**Art. KAT Kit allenamento tattico,** composto da : 7 bande elastiche di metri 10 cadauna  
 Tactical training Kit, made of 7 Elastic bands 10 meter long each



**Art. 016824**

**ELASTICO BOA in gomma para mm. 7x18 rivestito con guaina di sicurezza lunghezza mt. 3 con un moschettone a ciascuna estremità, resistenza Kg. 30**

Rubber BOA 7x18 mm. with safety sheath 3 meter length, resistance 30 Kg.

pg.11



**Art. 016824**  
**ELASTICO BOA**

**Art. 016826**  
**CINTURA Senior**



**Art. 016827**  
**Paio polsini per elastico BOA**  
Pair of wristbands for Boa exercises



**Art. 016828**  
**Paio cavaliere per elastico BOA**  
Pair of anklebands for Boa exercises

Si suggerisce l'utilizzo dell'elastico BOA con una cintura o con un altro tra gli accessori disponibili

Utilization of rubber Boa is suggested with a belt or with another available accessory

**Art. 016825**

**CINTURA Junior da agganciare a elastico BOA diametro max cm.105**

Junior Belt for Boa traction - max diameter 105 cm.

**Art. 016826**

**CINTURA Senior da agganciare a elastico BOA diametro max cm.140**

Senior Belt for Boa traction - max diameter 140 cm.



**Art. 016829**  
**Pettorina per elastico BOA**  
Shoulder belt for Boa exercises



**Art. AKHF**

**Kit Home Fitness comprendente rinforza spalle, sistema carrucolare, bastone estensibile, Antonelast uomo, Antonelast donna**

Kit includes shoulder strenghtener, extensible stick, Antonelast for man and Antonelast for woman

pg.11

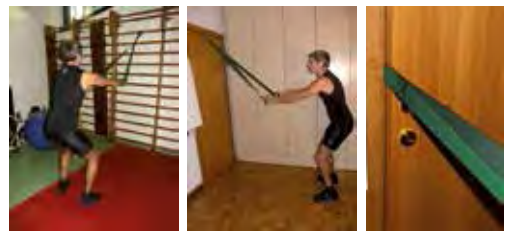

**Art. ARS.3 Banda Elastica rinforza spalla - può essere usata in ogni luogo che abbia un appiglio per la chiusura a velcro - anche in casa o in albergo, grazie alla presenza di uno spessore che a porta chiusa non fa scivolare l'attrezzo e non danneggia la porta**  
Elastic Band for shoulder injury training exercises



**Art. P21016 Pallina gr. 200 con elastico cm. 120 e moschettone - per riabilitazione della spalla**  
200 gr. ball with 120 cm. elastic for shoulder injury recovery exercises



**Art. SC010**

**OFFERTA KIT TECNICO SCUOLA CALCIO**

pg.10

Kit così composto: n.15 Paletti slalom Art.007

n. 15 basi ad imbuto Art.018 - n. 1 kit delimitatori Art.016 - n. 6 ostacoli over cm.12 Art.80.12  
n. 2 ostacoli over cm.20 Art.80.20 - n. 2 ostacoli over cm.30 Art. 80.30 - n. 2 ostacoli over cm.40 Art.80.40  
n. 12 corde salto Art.043P - n. 1 Scala a pioli Art. SL4 - n. 12 Maxidelimitatori h.cm.28 Art.019.1  
n. 12 cerchi piatti diam.cm.50 Art.CNP50 - n. 1 Tavoletta propriocettiva in ABS Art.168PC

**SOCCER SCHOOL KIT SPECIAL OFFER**

15 x Art.007 + 15 x Art.018 + 1 x Art.016 + 6 x Art.80.12 + 2 x Art.80.20 + 2 x Art.80.30 + 2 x Art.80.40  
+ 12 x Art.043P + 1 x Art.SL4 + 12(pieces) x Art.019.1 + 12 x Art.CNP50 + 1 x Art.168PC



Art. 007



Art. 043P

## FITNESS BODY-BUILDING

Art. S01108

Art. S01106



**Art. S01106**  
**Spalliera Svedese**  
**a 1 campata**  
**dim. 90x250 cm.**  
**in faggio evaporato**  
Swedish Wall Bar 1 span

● pg.14

**Art. S01108**  
**Spalliera Svedese**  
**a 2 campate**  
**dim. 180x250 cm.**  
**in faggio evaporato**  
Swedish Wall Bar 2 spans



**Art. S00908**  
**Panca per addominali imbottita**  
**agganciabile a spalliera**  
Abdominal bench to be fixed to  
Swedish Wall Bar



**Art. UNG05 / UNG1 / UNG2 / UNG3 / UNG4 / UNG5**  
**Coppia Manubri in ghisa rivestiti**  
**Kg. 0,5-1-2-3-4-5 cadauno**  
Pair of Dumb Bells from 0,5 to 5 Kg. each one

● pg.12

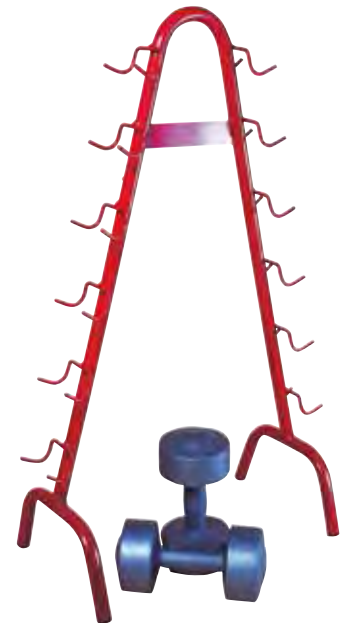

**Art. F301**  
**Porta manubri in ferro**  
Dumb Bell Rack



**Art. 17222**  
**Cintura Body Building h. cm. 10 - misure da S a XL**  
Body Building Leather Belt h. 10 cm.  
sizes from S to XL



**Art. AS196**  
**Coppia fermadischi a vite**  
Pair of plate holders with thread

pg.12

**Art. US176**  
**Coppia fermadischi a T**  
Pair of T-shaped plate holders



**\*Fermadischi a vite inclusi**  
Plate holders with thread included

**\*Art. US304/US305**  
**Bilanciere** Weight bar  
cm. 150 / cm. 180

**\*Art. US301** Manubrio a dischi inseribili cm. 35  
Hand bar length 35 cm.



**\*Art. US303**  
**Bilanciere sagomato**  
Bar cm. 120



**Art. UN640**  
**Dischi in ghisa foro mm.26**  
Kg. 0,5 - 1 - 2 - 5 - 10  
15 - 20 cadauno  
Cast Iron Weight Plates  
hole 26 mm.



**Art. DGG**  
**Dischi in ghisa foro mm.26 rivestiti in gomma**  
Kg. 0,5 - 1 - 2 - 5 - 10 - 15 - 20 cadauno  
Cast Iron Weight Plates hole 26 mm. covered with rubber



**Art. US287**  
**Coppia fermadischi a molla**  
Pair of spring plate holders

**Art. F302**  
**Porta dischi in ferro**  
Weight Plates Rack



**Art. 17203**  
**Paio guanti Lycra**  
misure da XS a XL  
vari colori  
Gym Gloves Lycra



pg.12

**Art. 30907**  
**Paio guanti Premium Pro**  
misure da S a XL  
vari colori  
Gym Gloves Premium Pro



**Art. AHF-093**  
**Paio Cavigliere Kg. 2,5 cadauna con pesi estraibili**  
Pair of Ankle Weights 2,5 Kg. each removable weights



**Art. 13382 / 13383 / 13384 / 30937**  
**Paio Cavigliere Kg. 0,5 - 1 - 1,5 - 2 cadauna**  
Pair of Ankle Weights 0,5 - 1 - 1,5 - 2 Kg. each one



**Art. 29922**  
**Barra elastica Power Spring**  
**(sino ad esaurimento)**  
Elastic Bar (until available)



**Art. 9939 - Barra Entroporta - Door Bar**

pg.13



**Art. 9941**  
**Coppia maniglie per flessioni**  
Push-up handles

**New!**



**Art. AHF-047**  
**Ruota doppia per addominali**  
Double Wheel for abdominal muscles

**New!**



**Art. AHF-074**  
**Coppia maniglie ruotabili per flessioni**  
Turnable Push-up handles



**Art. 29920**  
**Coppia Tenaglie stringimano con spugna**  
Pincers for hand strengthening



**Art. 18142**  
**Estensore con elastici**  
Chest-Expander



**Art. AHF-063**  
**Contapassi**  
Step Counter

pg.13

**Art. FT1.P**  
**Cardiofrequenzimetro Polar FT1: frequenza cardiaca in bpm, target zone manuale, orologio, cronometro, trasmissione segnale codificata, con fascia toracica**  
Heart pulse Polar FT1 multi-functions



**Art. AHF-064**  
**Contapassi multifunzione**  
Multi-function Step Counter

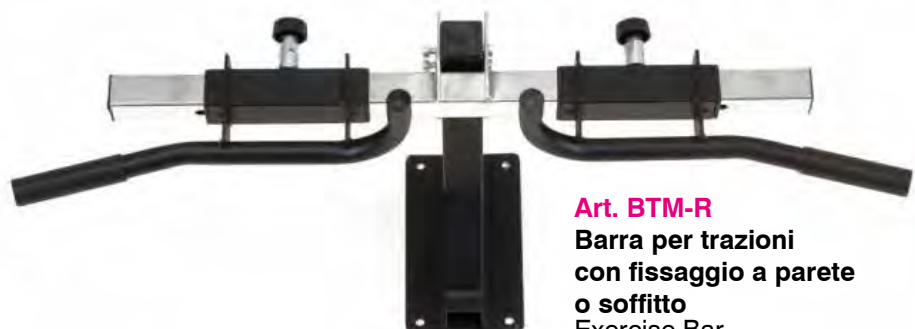

**Art. BTM-R**  
**Barra per trazioni con fissaggio a parete o soffitto**  
Exercise Bar



**Art. STX-1**  
**Ministepper**  
Tensione a pistoni idraulici.  
Computer a 3 funzioni: tempo,  
numero steppate, pulsazioni.  
Peso massimo utilizzatore 100 kg.  
Ministepper with hydraulic rams

pg.13

**Art. OCST**  
Gradino step a 2 altezze (10-15 cm.)  
con antiscivolo dim. cm. 68x30  
Step 2 heights  
(10-15 cm.) with anti-skid dim. 68x30 cm.



pg.14

**Art. WBX-70**  
**Power Tower**  
Attrezzo multifunzione ideato per l'allenamento intensivo  
di tutto il corpo senza l'utilizzo dei pesi  
Tubolare a sezione quadrata da 5 cm.  
Peso massimo utilizzatore 120 Kg.  
Multi purpose tool for intensive  
body training without weights



**Art. AHF-003**  
Gradino step regolabile a 3 altezze  
(cm. 15-20-25)  
superficie antiscivolo dim. cm. 89x39  
Step adjustable at 3 different heights  
(maximum height 25 cm.)  
with anti-skid surface dim. 89x39 cm.



**Art. E680**  
Bracciale porta oggetti  
in neoprene cm.14,5x8x2  
Neoprene arm wallet

pg.13



**Art. AHF-092**  
Fascia da braccio  
porta smartphone  
Arm smartphone holder



**New!**

**Art. WBK-400**  
Panca multifunzione  
telaio in acciaio,  
schienale regolabile  
portata massima kg. 120  
Weight lifting Bench



**New!**

**Art. WBK-500**  
Panca pesi con supporti  
bilanciere, telaio in acciaio,  
schienale regolabile  
peso max utilizzatore kg. 100  
Weight lifting Bench  
with bar holders

**ATTENZIONE:** questi prodotti sono concepiti esclusivamente per uso home fitness, perciò la garanzia non copre il loro utilizzo presso palestre o centri sportivi



**Art. WBX-80**  
Panca piana/90° Power Bench  
rinforzata (abbinabile con Power Rack)  
Power Bench

pg.14



**New!**

**Art. GYM1000**  
Stazione Multifunzione  
dotata di torre per dorsali, pressa per  
pettorali, attrezzo per le gambe, vogatore,  
cuscino per bicipiti - carico massimo 60 Kg.  
15 esercizi praticabili  
Peso massimo utilizzatore 120 Kg.  
Multi purpose machine



**Art. WBX-50**  
Power Rack  
Supporti per bilanciere  
Altezza e larghezza  
regolabili  
Dotato di 2 rimessaggi  
per dischi  
Peso massimo  
caricabile 200 Kg.  
Supports for weight bar

**ATTENZIONE:** questi prodotti sono concepiti esclusivamente per uso home fitness, perciò la garanzia non copre il loro utilizzo presso palestre o centri sportivi



**Art. 729761**  
Panca a inversione chiudibile  
Schienale rigido imbottito  
Regolabile secondo l'altezza dell'utilizzatore: minima cm. 147, massima cm. 198  
Peso max utilizzatore 100 Kg.  
Inversion Bench



**Art. WBK-100**  
Panca per addominali chiudibile  
portata kg. 100  
Bench for abdominal muscle training

pg.14



**Art. WBK-600**  
Panca multifunzione a cavi elastici richiudibile  
Foldable multi-function bench



**Art. AB-CNH**  
AB Crunch Master richiudibile



**Art. GWM13**  
Pedaliera manuale utilizzabile da seduti per gli arti inferiori e appoggiata sul tavolo per gli arti superiori  
Peso 5 Kg. - con computer  
Intensità sforzo regolabile  
Cycling device for arm and leg exercises

pg.13



**Art. GWE13**  
Pedaliera elettrica per la ginnastica passiva degli arti inferiori e superiori  
Velocità regolabile con telecomando  
Peso 6 Kg. - con computer  
Cycling electric device for arm and leg exercises

**Art. BFK-300**

Bici da camera con freno magnetico  
Regolazione dell'intensità manuale a 8 posizioni  
Volano da 4 Kg. - Computer a 6 funzioni: tempo, velocità, distanza, calorie, scan, pulsazioni con sensori Hand Pulse  
Peso massimo utilizzatore 100 Kg. - Peso dell'attrezzo 20 Kg.  
Cyclette Magnetic with 6 function computer



pg.13

**Art. BRX-60**

Bici da camera con freno magnetico  
Regolazione dell'intensità manuale a 8 posizioni  
Volano da 7 Kg. - Computer a 6 funzioni: tempo, velocità, distanza, calorie, odometro, pulsazioni con sensori Hand Pulse  
Peso massimo utilizzatore 110 Kg.  
Peso dell'attrezzo 24 Kg.  
Cyclette Magnetic with 6 function computer



**New!**

**ATTENZIONE:** questi prodotti sono concepiti esclusivamente per uso home fitness, perciò la garanzia non copre il loro utilizzo presso palestre o centri sportivi

**Art. BRX-RC**

Bici da camera con freno magnetico e sedile con schienale  
Regolazione dell'intensità manuale a 8 posizioni  
Volano da 7 kg  
Computer a 7 funzioni: tempo, velocità, distanza, calorie, pulsazioni con sensori Hand Pulse, odometro, scan  
Peso massimo utilizzatore 110 Kg.  
Peso dell'attrezzo 28,5 Kg.  
Cyclette Magnetic with 7 function computer, seat adjusting system



**Art. SRX60**

Spinning Bike  
con volano da Kg. 20  
Trasmissione a cinghia con pignone fisso  
Sistema di frenata a pattini con feltri  
Computer con LCD (velocità, tempo, distanza, calorie, odometro, scan, hand pulse)  
Sella regolabile in orizzontale ed in altezza  
Manubrio regolabile in altezza con appoggio per l'avambraccio  
Portaborraccia  
Peso massimo utilizzatore 125 Kg.  
Peso dell'attrezzo 41 Kg.  
Cyclette Magnetic with seat and handle-bar adjusting systems



**Art. 18220**

**Coprisella spinning**  
Seat cover  
for spinning bike







**ATTENZIONE:** questi prodotti sono concepiti esclusivamente per uso home fitness, perciò la garanzia non copre il loro utilizzo presso palestre o centri sportivi

**Art. TFK-MAG**

**TAPIS ROULANT MAGNETICO TFK-SLIM-MAG**

piano di corsa cm.38x102

sistema di frenaggio magnetico su 8 posizioni

doppio volano Kg.6 - peso massimo

utilizzatore Kg.100 - display LCD indicante velocità,

frequenza cardiaca, distanza, tempo,

consumo calorico, scan, rilevazione cardio Hand Pulse

Tapis roulant magnetic with no engine,

with multi function computer

pg.13



**Art. TFK-250E**

**TAPIS ROULANT TFK-250 EVO**

motore 1,75/2,75 HP DC - velocità 0,8-14 Km/h

inclinazione manuale - piano di corsa cm. 42x123

peso massimo utilizzatore 100 Kg.

1 programma libero, 12 presettati, display LCD

indicante velocità, frequenza cardiaca, distanza,

tempo, consumo calorico, programma in esecuzione

Tapis roulant with 1,75/2,75 hp engine and

multi program computer



**Art. TFK-455**

**TAPIS ROULANT TFK-455 SLIM**

motore 2,00/3,00 HP DC - velocità 0,8-16 Km/h

inclinazione elettrica - piano di corsa cm.42,5x127

peso massimo utilizzatore 110 Kg.

1 programma libero, 12 presettati, display LCD

indicante velocità, inclinazione, frequenza cardiaca

tramite Hand Pulse, distanza, tempo,

consumo calorico, programma in esecuzione

Tapis roulant with 2/3 hp engine and multi program computer

**Art. TRXRC**  
**Vogatore Rower Compact - display LCD indicante**  
**numero vogate, calorie, tempo, scan**  
**regolazione sforzo su 12 livelli**  
**peso max utilizzatore 110 Kg.**  
Rower machine with computer



## CASACCHE - Mesh Shirts



**Art. 088-A**

### Casacca traforata fluo taglia adulto

Fluo pierced training bib adult size - colors as in the picture



**Art. 088-B**

### Casacca traforata fluo per bambini fino a 9 anni

Fluo pierced training bib small size - colors as in the picture



pg.16



**Art. 088-D**

### Casacca traforata double-face fluo taglia adulto colori rosso/blu - giallo/arancio

Fluo pierced training bib double-face adult size  
colors red/blue - yellow/orange



**Art. GIL01**

### Gilet steward

Colori giallo - arancio  
Colors yellow - orange

## PANTALONCINI - CALZE - GUANTI - T-SHIRT - GIACCHE PIOGGIA Shorts - Socks - Gloves - T-shirt - Rain jackets



**Art. MF01**  
Pantaloncino da allenamento  
100% poliestere  
taglie dalla 3XS alla XXL  
Colori: royal, bianco, bordeaux,  
verde, navy, rosso, nero  
Shorts in polyester  
size from 3XS to XXL  
Colors: white, red, royal,  
blue, black, brown, green



**Art. IS005**  
Paio calze calcio con piede  
Taglie  
Bimbo: 29-34  
Ragazzo: 35-40  
Uomo: 41-46  
Colori: royal, giallo limone, bianco,  
bordeaux, navy, rosso, nero,  
Pair of soccer socks sizes: Kid, JR, SR  
Colors: white, red, royal, blue, black, brown,  
lemon yellow

pg.16



**Art. TOGA**  
Guanti in acrilico elasticizzati  
con antiscivolo - colore nero  
misura junior e senior  
Black elastic acrylic Gloves  
with anti-skid  
size junior and senior



**Art. TOBA**  
Berretto in acrilico  
nero, navy  
taglia junior e senior  
Winter Cap  
size junior and senior



**Art. TOS1**  
Scaldacollo in pile  
taglia unica regolabile  
Neck warmer in pile  
one size fits all



**Art. 07761A**  
Giacca pioggia con marsupio  
taglie dalla XXXS alla XXL  
colori: navy, rosso e nero  
Rain Jacket - sizes XXXS to XXL  
colors: blue, red and black



**Art. TSG10/TSG11**  
T-SHIRT colori: bianco, nero, rosso,  
verde, giallo, arancio, blu, royal  
misure: bambino dalla S alla XL adulto dalla S alla XXL,  
neutra oppure personalizzata con logo ad un colore  
(ordine minimo per la personalizzazione 50 pezzi)  
T-Shirt various colors and size, also with your logo on request  
(minimum order for customization 50 pieces)

**Art. SB099**

**TUBOLARE BARRET in microfibra 108 dinari**  
Prodotto tecnico brevettato come modello d'uso CEE - Made in Italy  
Lascia traspirare la pelle e ripara dal freddo e dal vento  
utilissimo in molteplici situazioni:  
durante e dopo gli allenamenti, durante gli incontri,  
per sostenere la tua squadra, nel tempo libero, in moto etc.



**Prodotto bi-elastico senza cuciture**  
bi-elastic seamless

pg.16

Barret TUBOLAR HAT in microfiber - made in Italy patented  
BTH lets your skin breath while protecting you from cold and wind  
you can wear it during or after training, during the game, in your spare time,  
to support your team, when riding your bike etc.



utilizzabile come scaldacollo, foulard, bandana, fascia, passamontagna etc.



it can change shape from neck warmer to head band to foulard to bandana

**PRODOTTO TECNICO**  
**TECHNICAL PRODUCT**



**A differenza del comune prodotto in pile, la microfibra del Tubolare Barret impedisce il surriscaldamento e l'eccessiva sudorazione della pelle, grazie alla sua speciale traspirazione e leggerezza**

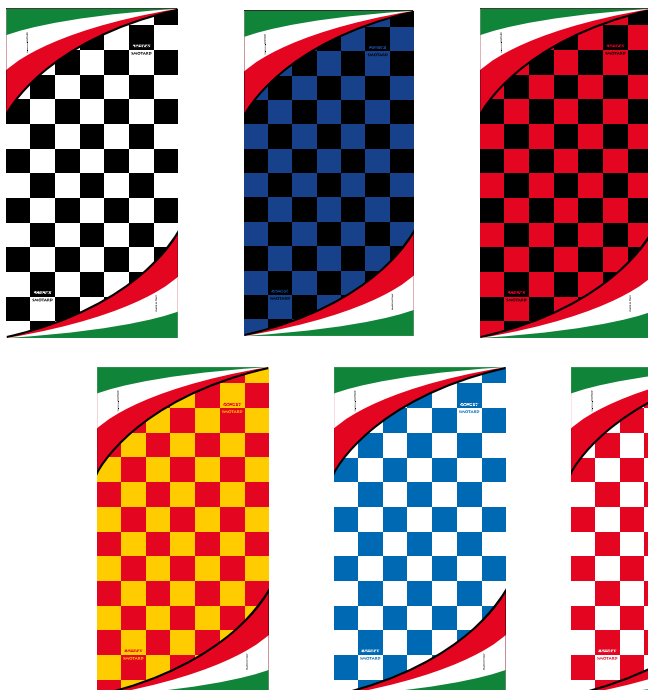
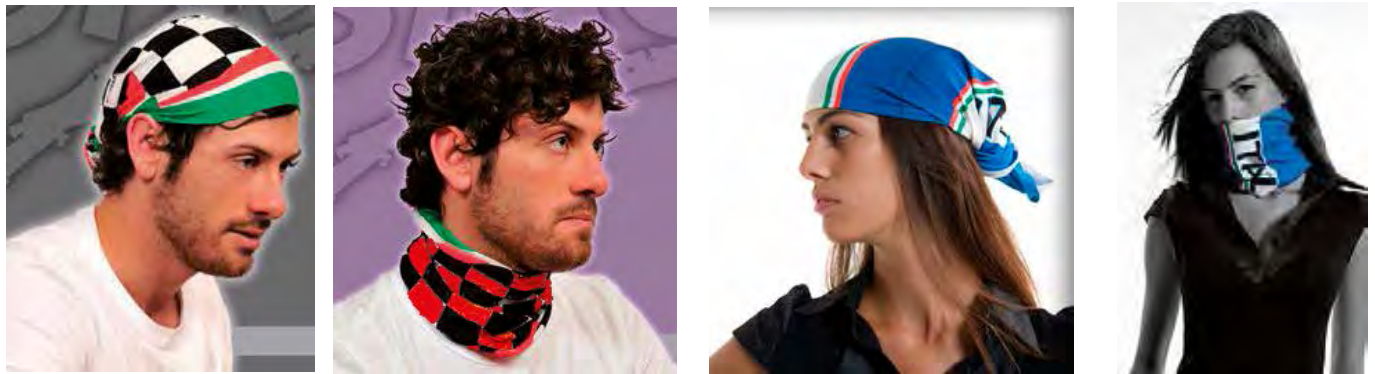

**Colori disponibili:**  
bianco/nero, nero/azzurro, rosso/nero, bianco/celeste, bianco/rosso, giallo/rosso, azzurro nazionale italiana (prodotto personalizzabile su richiesta per ordine minimo di 100 pezzi, con spese per elaborazione grafica da definire)

Colors available as in the pictures  
Barret tubular HAT can be personalized with your logo and colors with a minimum order of 100 pieces (graphic work not included in the price)



**NUMERAZIONI  
TERMOALDABILI  
NUMBERS  
FOR UNIFORMS**

**Colori disponibili:**  
bianco, giallo,  
rosso, verde, royal,  
blu, granata, nero,  
oro, argento  
Available colors:  
white, yellow, red,  
green, royal, blue,  
brown, black, gold,  
silver

● pg.16 ● pg.17

**Art. PG23**  
Numeri termosaldabili  
Serie Omega h.23 cm.  
in confezione blister da 1 a 22  
Numbers for sport uniforms  
Omega series 23 cm. height  
package from number 1  
to number 22

**Art. PG18**  
Numeri termosaldabili  
Serie Omega h.18 cm.  
in confezione blister da 1 a 15  
Numbers for sport uniforms  
Omega series 18 cm. height  
package from number 1  
to number 15

**Art. PG10**  
Numeri termosaldabili  
Serie Omega h.10 cm.  
in confezione blister da 1 a 22  
Numbers for sport uniforms  
Omega series 10 cm. height  
package from number 1  
to number 22

**Art. PN23**  
Numeri termosaldabili  
Serie Omega h.23 cm.  
numeri singoli (da 0 a 9)  
Single numbers for sport uniforms  
Omega series 23 cm. height  
(from 0 to 9)

**Art. PN18**  
Numeri termosaldabili  
Serie Omega h.18 cm.  
numeri singoli (da 0 a 9)  
Single numbers for sport uniforms  
Omega series 18 cm. height  
(from 0 to 9)

**Art. PN10**  
Numeri termosaldabili  
Serie Omega h.10 cm.  
numeri singoli (da 0 a 9)  
Single numbers for sport uniforms  
Omega series 10 cm. height  
(from 0 to 9)



**Art. PG4**  
Numeri termosaldabili Serie Omega  
h.4 cm. in confezione blister numeri da 1 a 100  
colore bianco o nero  
Numbers for sport uniforms  
Omega series 4 cm. height  
package from number 1 to number 100  
black or white color



**Art. PP023**  
Profilo perimetrale in poliestere colorato  
per numeri Omega 23 da 0 a 9  
(per ottenere numeri bicolored con doppia pressata)  
Color Frame for Omega 23 numbers from 0 to 9  
to create bicoloured numbers (assorted colors)

## PARASTINCHI - Shinguards



**Art. IS30HS**  
**Paio parastinchi senza cavigliera misura S-M-L-XL**  
Pair of shinguards without ankle protection size S-M-L-XL

**Art. PSCV**  
**Paio parastinchi senza cavigliera misura adulto e bambino**  
Pair of shinguards without ankle protection junior and senior size



**INNOVATIVO PARASTINCO BARRET REALIZZATO CON SPECIALI LISTELLI ANATOMICI  
LEGGERRISSIMO MA CON ALTA RESISTENZA ALL'IMPATTO**  
BARRET SPECIAL SHINGUARDS anatomic, very light and highly resistant to impact

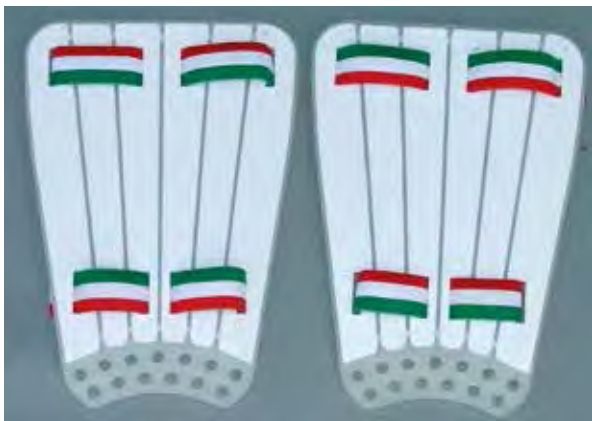

pg.16



**Art. BP90**

**Paio parastinchi Barret senza cavigliera misura unica**  
Pair of Barret shinguards without ankle protection one size fits all



**BREVETTATO  
PATENTED**



**Art. PBC**  
**Paio parastinchi con cavigliera misura adulto**  
Pair of shinguards with ankle protection senior size



## FASCE CAPITANO - GUANTI PORTIERE - Captain's Armbands - GK Gloves



**Art. 150**  
Fascia capitano elastica  
misura adulto  
Elastic Captain's armband  
size adult

**Art. 150.B**  
Fascia capitano elastica  
misura bambino  
Elastic Captain's armband  
size children

pg.17



**Art. 150F** Fascia capitano elastica  
mis. adulto colore giallo o arancio fluo  
Elastic Captain's armband adult size  
colors: fluorescent yellow and orange



**Art. 150V.9**  
Fascia capitano con velcro, taglia adulto  
colori: bianco, rosso, giallo fluo, verde,  
blu e arancio fluo - h. cm. 9  
Captain's armband adjustable length - 9 cm. height  
size adult - colors: white, red, fluo yellow,  
blue, green, fluo orange



**Art. 150V / 150V.B**  
Fascia capitano con velcro, taglia adulto o bambino  
Modello Champions colori bianco, rosso, giallo, verde,  
blu, fucsia, arancio - h. cm. 6,5  
Captain's armband adjustable length - 6,5 cm. height  
size adult or children  
colors: white, red, yellow, blue, green,  
fuchsia, orange



**Art. 150V.9N**  
Fascia capitano neutra con velcro, taglia adulto  
h. cm. 9 - colori: giallo fluo, giallo, arancio,  
bianco, rosso, verde, blu  
Captain's armband with no "C" printed  
adjustable length 9 cm. height size adult  
colors: fluo yellow, yellow, orange, white, red,  
green, blue



**Art. 1000PG**  
Paio Guanti portiere misure da 6 a 11  
Pair of Goal Keeper Gloves  
Size from 6 to 11

pg.16

**Art. F30BG**  
Paio Guanti  
portiere junior  
misure da 4 a 8  
Pair of Goal  
Keeper Gloves  
Size from 4 to 8



I colori dei guanti raffigurati nelle immagini possono variare

## TACCHETTI ED ACCESSORI PER SCARPE - Studs and Shoe accessories



● pg.14

● pg.15







**Art. 317 / 318**  
**Paio tendiscarpe a molla,**  
**misura 40-42 / 43-45**  
 Shoe stretchers with spring,  
 size 40-42 / 43-45

pg.15

**Art. BLS4**  
**Lastrina antitrauma ritagliabile in gel forata**  
**spessore mm.4 dimensioni cm.14x28**  
**da utilizzare a contatto con la pelle del piede**  
**dentro la scarpa in caso di ferite, vesciche o**  
**contusioni: attutisce il dolore derivante dalla**  
**corsa e dall'impatto con la palla**  
 Anti-shock pierced gel thickness 4 mm. size  
 cm.14x28 you can cut it and place it inside your  
 shoe against the skin to prevent pain from running  
 and kicking in case of small foot injuries



**Art. 326 / 326FL / 327 / 327FL / 328 / 328FL**  
**Paio lacci per scarpe cm.120-150-180**  
**colori nero, bianco, giallo fluo, verde fluo, arancio fluo**  
 Pair of shoe laces 120-150-180 cm. long  
 colors: black, white, fluo yellow, fluo green, fluo orange



**Art. SOL.SP**  
**Paio solette in gel**  
**profumate ritagliabili**  
 Gel Insoles



**Art. ALZ.SP**  
**Paio Alzatacco in gel**  
**taglia 1 donna**  
**taglia 2 uomo**  
 Gel under heel softeners  
 woman and man sizes



**Art. 21654**  
**Paio solette**  
**Spugna Sport**  
 Sport Insoles

pg.15



**Art. E6694**  
**Paio Alzatacco in silicone**  
**misura S (33/36) - M (37/40)**  
**L (40/44) - XL (44/48)**  
 Silicone under heel softeners  
 various sizes



● pg.15

**Art. S489**  
**Spazzola**  
**in setola naturale**  
 Shoe Brush

**Art. 238.1**  
**Grasso Aquila Kg.1**  
 Aquila Grease for shoes  
 Kg. 1

**Art. 238**  
**Grasso Aquila ml. 100**  
 Aquila Grease for shoes  
 ml. 100

**Art. 34071A**  
**Spray**  
**impermeabilizzante**  
 Spray waterproofing



**Art. D122X**  
**Spray Dilato ml. 200**  
**ammorbidente**  
 Spray to soften leather  
 soccer shoes



**Art. TE.540.01**  
**Zerbino pulisciscarpe**  
**in plastica con ventose**  
**dimensioni cm.35x27**  
 Shoe cleaning device  
 in plastic with suckers  
 dimension 35x27 cm.

● pg.15

● pg.16



**Art. FA270**  
**Macchina lavascarpe con 4 spazzole sostituibili**  
**getti incrociati regolabili ad alta pressione**  
**completo di poggiamani e 4 fori di fissaggio a terra**  
**in dotazione fascetta in acciaio per collegamento tubo**  
**mm 15x21 (non incluso) alla rete idrica.**  
 Shoe washing device - high pressure crossed water jets  
 iron frame with handles - replaceable brushes  
 easy fixing to the floor with 4 holes



## MATERASSINI - Mats

**Art. 044**  
**Materassino pieghevole**  
**alta densità**  
**cm. 180 x 50 x 0,7**  
Folding foam Mat  
high density  
cm. 180 x 50 x 0,7

**Art. 044-A**  
**Materassino pieghevole**  
**alta densità**  
**cm. 180 x 60 x 0,7**  
Folding foam Mat  
high density  
cm. 180 x 60 x 0,7

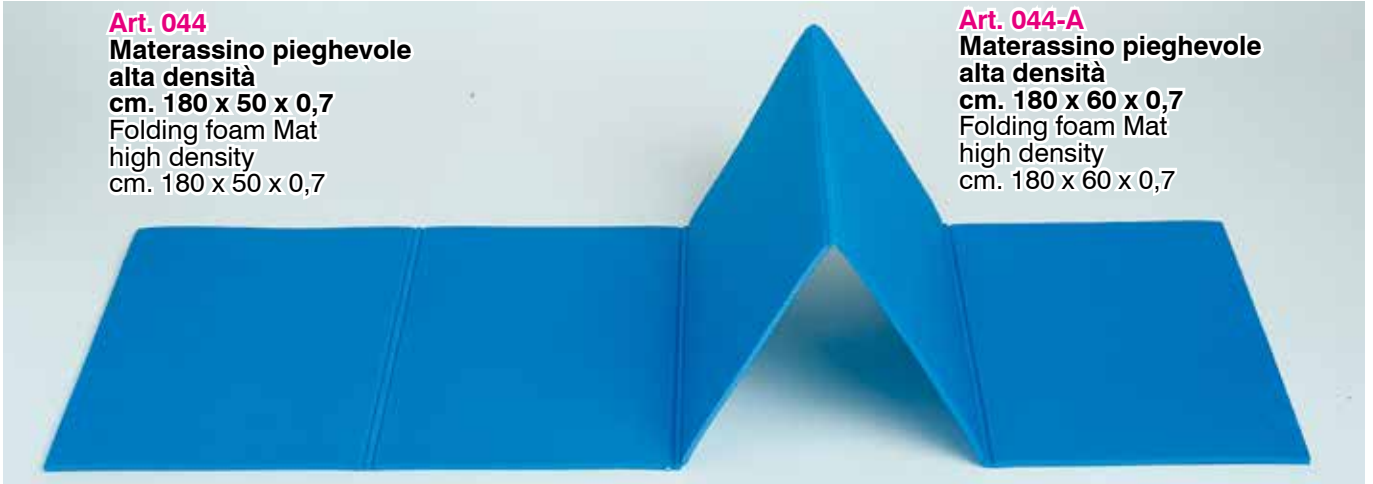

**Art. 044-R**  
**Materassino arrotolabile**  
**alta densità**  
**cm. 180 x 50 x 0,6**  
Rolled foam Mat  
high density 180 x 50 x 0,6 cm.

**Art. AS803**  
**Materassino exercise longer mat**  
**imbottito e serigrafato cm.180x60x2,5**  
PVC Mat 180x60x2,5 cm.



**Art. 30924**  
**Materassino arrotolabile Yoga**  
**cm. 172x60x0,4**  
Rolled Yoga Mat 172x60x0,4 cm.

## LAVAGNE TATTICHE - Tactical Boards



**Art. 087**

**Lavagna magnetica cm. 60x90 cancellabile con cornice metallica**  
Tactical board 60x90 cm. magnetic and erasable with metal frame

**Art. 087.BO**

**Borsa per lavagna magnetica Art. 087 cm. 60x90**  
Bag for tactical board Art. 087 60x90 cm.



**Art. M087TP**

**Treppiede di sostegno in acciaio verniciato per lavagna Art. 087 (lavagna esclusa)**

Painted steel tripod for board Art. 087 (board not included)

pg.18

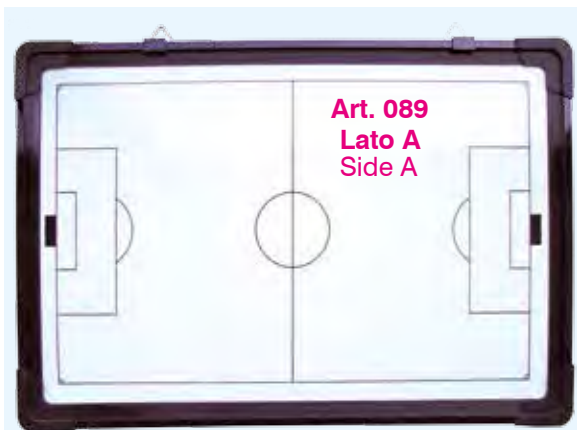

**Art. 089**  
**Lato A**  
**Side A**

**Art. 089**

**Lavagna magnetica bifacciale cancellabile con borsa cm. 45x30**  
2 face Tactical Board magnetic and erasable 45x30 cm. with bag



**Art. 089-P**

**Lavagna magnetica cancellabile pieghevole cm. 46x25**  
Foldable Tactical Board magnetic and erasable 46x25 cm.



**Art. 089**  
**Lato B**  
**Side B**

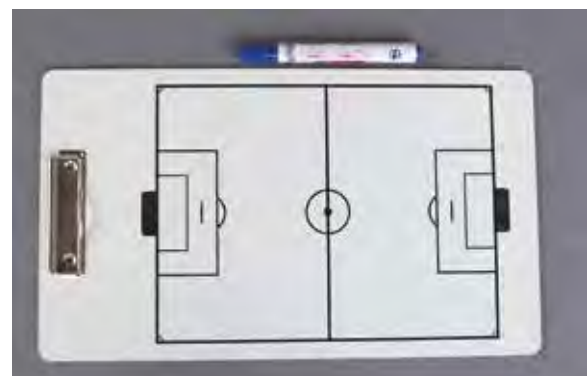

**Art. 089-A**

**Lavagna bifacciale cancellabile cm. 40x23**  
2 face Tactical Board erasable, 40x23 cm.



**Art. CSRK**

**Lavagna Tattica Calcio magnetica cancellabile con block-notes cm. 40x23**  
Magnetic Tactical Board 40x23 cm. erasable

**New!**

pg.18



**Art. PAL-B**

**Pal Block - Blocco tascabile con 25 pagine copertina cancellabile**  
Pocket Block notes  
25 pages with erasable cover



**Art. PM**

**Serie pedine magnetiche di ricambio**  
Spare magnetic pieces for Tactical boards

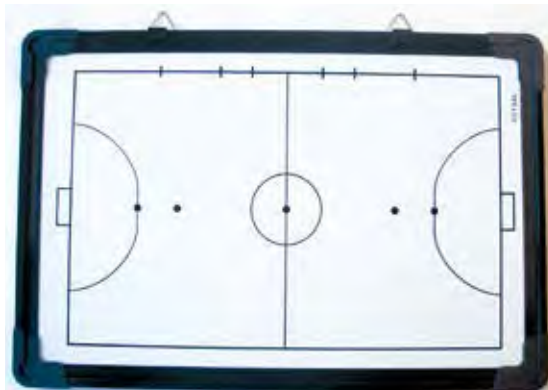

**Lato A**  
Side A



**Lato B**  
Side B

**Art. 089CM**

**Lavagna Tattica Calceetto bifacciale magnetica e cancellabile cm. 45x30**  
2 face Futsal Tactical Board magnetic and erasable 45x30 cm.

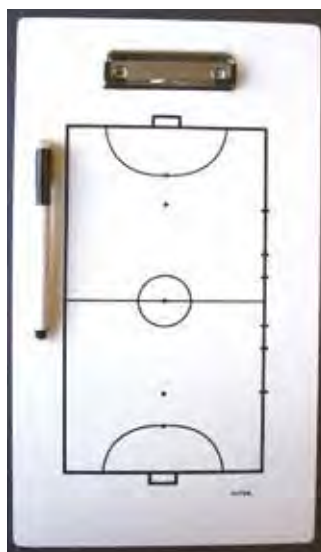

**Art. 089-C**

**Lavagna Tattica Calceetto bifacciale cancellabile cm. 40x23**  
2 face Futsal Tactical Board 40x23 cm. erasable



**Art. 18330**

**Lavagna magnetica cancellabile pieghevole Multisport (Calcio, Basket, Volley, Rugby, Badminton, Tennis, Floorball etc.)**  
dimensioni cm. 32x22  
Multisport Foldable Tactical Board magnetic and erasable 32x22 cm.

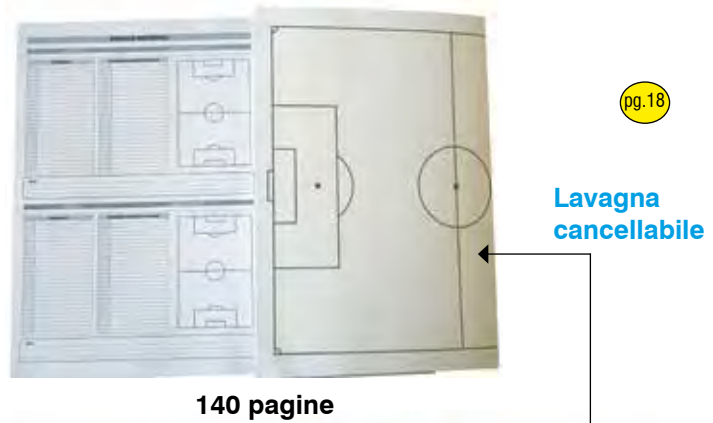
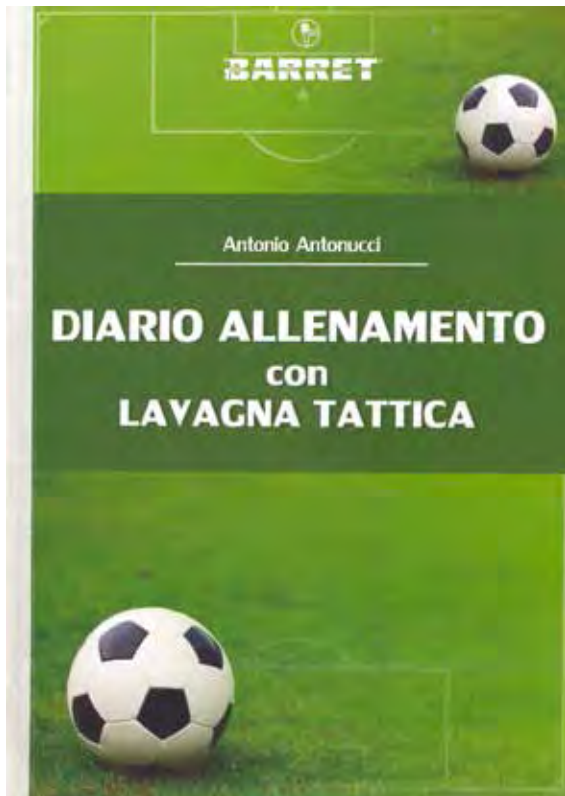

**Art. DALT DIARIO ALLENAMENTO per l'allenatore di calcio con lavagna tattica**

Lo strumento ideale per programmare e registrare durante il corso della stagione tutto ciò che riguarda la preparazione fisica generale, specifica e speciale, i test di valutazione, la preparazione psico-tattica teorica e pratica, la preparazione psico-cinetica, gli esercizi tecnico-tattici, il riscaldamento, il defaticamento e la preparazione post-infortunio della Vostra squadra di calcio e dei singoli giocatori che la compongono. E' inoltre fondamentale per l'annotazione di tutto ciò che riguarda le partite amichevoli e le partite di campionato, in relazione agli avversari da incontrare. Il diario è corredato di una retrocopertina pieghevole utilizzabile come lavagna tattica cancellabile a 3 facce

## BORRACCE - Water Bottles

pg.17

Art. 306

**Kit 6 Borracce da 1 lt. con cestello**  
Kit 6 one liter water bottles with holder

**Certificate per uso alimentare**  
Food grade certified



Art. K8

**Borraccia da 1 litro**  
1 liter Water Bottle

Art. B500ML

**Borraccia da 1/2 litro**  
1/2 liter Water Bottle

Art. 308.C

**Cestello per 6 borracce in plastica**  
Holder for 6 water bottles in plastic



Art. K8S6

**Kit 8 Borracce da 1 Lt con cestello pieghevole**  
Kit 8 one liter water bottles with foldable holder



Art. OC8

**Cestello per 8 borracce in plastica pieghevole**  
Foldable Holder for 8 water bottles in plastic



Art. IRTT

**Distributore termico 6 lt con rubinetto**  
Thermos 6 lt with tap

**GHIACCIO - TAPE - CREME - OLI**  
Ice - Tape - Creams - Oils



**Art. 164**  
**Ghiaccio spray**  
ml. 400  
Ice spray 400 ml.



**Art. 165**  
**Ghiaccio**  
in busta monouso  
Ice in envelope



**Art. NE2.5**  
**Nastro economico cm. 2,5x13,7 mt**  
Tape cm. 2.5x13,7 mt.

**Art. NE5**  
**Nastro economico cm. 5x13,7 mt**  
Tape cm. 5x13,7 mt.

**Art. N2.5**  
**Nastro tipo strappal cm. 2,5x10 mt**  
Tape strappal cm. 2,5x10 mt.

**Art. N5**  
**Nastro tipo strappal cm. 5x10 mt**  
Tape strappal cm. 5x10 mt.



**Art. 9254**  
**Salvapelle**  
Skin Protection

● (pg.17) ● (pg.18)



**Art. IDNC38**  
**Nastro adesivo colorato fermacalze**  
cm. 3,8x13,7 mt.  
colori : rosso, nero, blu, verde e giallo  
Color Tape stop stockings  
in red, black, blue, green and yellow



**Art. TPG09**  
**Fraplast cm. 8 (Tensoplast)**



**Art. IPT02**  
**Forbice**  
taglia taping  
in acciaio inox



**Art. T255**  
**Kinesio Tape**



**Art. IPT01**  
**Cutter taglia bendaggi**





**Art. ONC**  
**Olio riscaldante 500 ml**  
stimola la circolazione,  
tonifica la muscolatura,  
previene le lesioni muscolari  
microtraumatiche  
Oil 500 ml  
for muscle warm up, stimulating  
blood circulation  
and preventing micro injuries



**Art. CNC**  
**Crema riscaldante 250 ml**  
stimola la circolazione,  
tonifica la muscolatura,  
previene le lesioni muscolari  
microtraumatiche  
Cream 250 ml  
for muscle warm up, stimulating  
blood circulation and preventing  
micro injuries



**Art. IRVF**  
**Vaselina filante**  
per curare le zone della pelle a  
maggiore sollecitazione  
Vaseline avoiding skin problems



**Art. IRFA**  
**Fango argilla per impacchi**  
**dopo distorsioni,**  
**per assorbimento ematomi**  
Special mud to be used after  
injuries (i.e. sprained ankles)  
and to absorb bruises

pg.18



**Art. IJGE**  
**Crema Jel Gestic**  
coadiuvante per  
infiammazioni, contusioni  
e lesioni dell'apparato  
muscolare  
Cream Jel Gestic  
for treating minor injuries  
and sore muscles



**T10R**  
**GEL**  
**FREDDO**  
refrigerante  
immediato su  
contusioni o  
strappi muscolari  
Cold Gel for  
immediate  
application on  
bruises and sore  
muscles

**T17G**  
**CUSCINETTO**  
**IN GEL**  
dim. cm.17x27  
(effetto freddo  
ed effetto caldo)  
Gel Pillow  
17x27 cm.  
(both for cold  
and hot therapy)

T17G

## BANDIERINE - Flags



**Art. 074**  
**Kit completo**  
**4 paletti**  
**calcio d'angolo**  
**con snodo**  
**in PVC Ø mm.32**  
**(bandierine colore**  
**giallo o rosso)**  
**Kit 4 complete**  
**flexible Corner Poles**  
**in PVC Ø 32 mm.**  
**(yellow or red flags)**



**Art. 074RP**  
**Kit completo**  
**4 paletti**  
**calcio d'angolo**  
**con snodo**  
**rinforzati con tubo**  
**in polipropilene**  
**Ø mm.40**  
**(bandierine colore**  
**giallo o rosso)**  
**Kit 4 complete**  
**flexible Corner**  
**Poles reinforced**  
**with polypropylene**  
**pipe Ø 40 mm.**  
**(yellow or red flags)**



**Art. 073**  
**Kit completo**  
**4 paletti calcio d'angolo**  
**in PVC Ø mm.32**  
**(bandierine colore giallo o rosso)**

**Kit 4 complete Corner Poles**  
**in PVC Ø 32 mm.**  
**(yellow or red flags)**

pg.18



**Art. 368**

**Art. 368 Set ricambi**  
**4 Bandierine calcio d'angolo**  
**colore giallo o rosso**  
**Set of 4 spare Corner Flags**  
**yellow or red color**



Art. 076



Art. 075

**Art. 075 / 076**

**Coppia Bandierine guardalinee gialle o a scacchi con aste in plastica**  
Pair of linesman's Flags yellow or checked with plastic sticks

pg.19



Art. 367-G

Art. 367-S

**Art. 367-G / 367-S**

**Coppia ricambi Bandierine guardalinee gialle o a scacchi**  
Pair of spare linesman's Flags yellow or checked



**Art. 13ALC**

**Coppia Bandierine guardalinee a scacchi fluorescenti con aste in alluminio e custodia**  
Pair of linesman's Flags fluorescent with aluminium sticks and holder



**Art. 172**

**Coppia Bandierine guardalinee elettroniche complete di ricevitore e valigetta**  
Pair of electronic linesman's Flags complete with signal receiver and case

pg.19

## ACCESSORI ARBITRO - Referee's accessories



**Art. 078**  
Fischio Fox 40 Classic senza pallina  
nero o colorato  
Whistle FOX 40 Classic

**078PD**  
Fischio arbitro senza pallina  
Fox 40 Classic CMG nero o  
colorato con imboccatura  
anatomica e cordoncino  
Whistle FOX 40 Classic CMG  
cushioned mouth grip  
(cord is included)

pg.19



**Art. 078SK**  
Fischio Fox 40 SONIK BLAST  
CMG con cordoncino - vari  
colori, con due camere sonore  
Whistle FOX 40 SONIK BLAST  
CMG with cord, various colors



**Art. 078CH**

Fischio senza pallina nero o colorato con cordoncino in confezione blister  
Plastic whistle without a ball various colors with cord

pg.19



**Art. 228C**  
Fischio in plastica  
nero con cordoncino  
Plastic black whistle with  
cord

**Art. 228**  
Fischio in plastica nero  
senza cordoncino  
Plastic black whistle  
without cord



**Art. 079C**  
Fischio cromato  
con cordoncino  
Chromed brass  
whistle with cord



**Art. FEFOX**  
Fischio elettronico  
Fox 40 con cordoncino  
potenza 125 dB  
Electronic Fox 40 whistle  
with cord



**Art. 080**  
Cordoncino Lanyard  
colore nero  
Nylon  
whistle cords Lanyard  
black color

pg.19



**Art. F40CAP**  
Cordoncino Fox antipanico  
regolabile, vari colori  
Fox whistle cord adjustable  
various colors



**Art. 9816**  
Polsino regolabile  
per fischietto Arbitro  
Adjustable wristband  
for referee's whistle



**Art. KCPFOX**  
Kit cronometro da polso  
e fischietto Fox 40 Sonik  
Blast con cordoncino  
Kit wrist Chronometer with  
Fox 40 Sonik blast whistle  
with cord



**Art. 081F** Coppia cartellini con  
custodia, matita e tabellino gara  
Yellow and red cards with holder,  
pen and game note card

**Art. GR15**  
Coppia cartellini  
giallo e rosso  
riscrivibili con pennarello  
(cancellabili con alcol)  
Rewritable yellow  
and red cards with pen  
(erasable with alcohol)



pg.19



**Art. 880147**  
Moneta per arbitro  
in plastica  
rosso/nera  
referee's coin



**Art. RYC02**  
Set 1 cartellino arbitro giallo e 1 rosso  
Set 1 yellow and 1 red card for referee



**Art. RCB**  
Cartellino arbitro blu  
Blue referee card

## COMPRESSORI - POMPE - MANOMETRI - CRONOMETRI Inflators - Pumps - Gauges - Chronos



**Art. 106**  
Compressore  
elettrico 220 Volt  
con borsa  
Electric Inflator  
220 Volt  
with bag



**Art. 107**  
Manometro misura pressione palloni con valvola  
(con indicazione pressioni consigliate per i vari sport)  
Pressure Gauge with valve  
(with indication of pressure for different sport balls)



**Art. US107**  
Manometro misura pressione palloni alta precisione  
con valvola (con indicazione  
pressioni consigliate per i vari sport)  
High precision pressure Gauge with valve  
(with indication of pressure for different sport balls)



**Art. 104-A** Pompa con ago - Pump with needle



**Art. PSS**  
Pompa a staffa  
con serbatoio  
All purpose  
Pump with tank

pg.19



**Art. 2005**  
Confezione 12 Aghi  
con valvola  
per gonfiaggio palloni  
Set 12 Needles  
with valve  
for inflating balls

**Art. 2005RC**  
Ago di ricambio  
per compressore Art. 106  
Spare needle  
for electric inflator Art. 106



**Art. 104-T**  
Pompetta in gomma soft  
con ago e valvola di sfiato  
ideale per gonfiaggio  
palloni in gomma  
Soft Pump with needle  
and valve  
for inflating rubber balls



**Art. CRN.G**  
**Cronometro digitale 1/100 sec.**  
 con visualizzazione di ora,  
 calendario, sveglia,  
 avvisatore sonoro  
 Digital Chronometer 1/100 sec.  
 displays hour, calendar, timer

**Art. CRN.E**  
**Cronometro digitale**  
 1/100 sec.  
 Digital Chronometer  
 1/100 sec.

**I MODELLI  
 DEI CRONOMETRI  
 POSSONO  
 VARIARE  
 MODELS MAY  
 CHANGE**



**New!**

pg.19

**Art. CR032**  
**Cronometro al  
 quarzo**  
**a 30 memorie**  
**resistente all'acqua**  
 Quartz Chronometer  
 30 memories  
 water resistant



**Art. CMT Contametri fino a m. 9999**  
 Meter Counter (until m. 9999)



**New!**

**Art. CR031**  
**Cronometro al quarzo a 500**  
**memorie resistente all'acqua**  
 Quartz Chronometer  
 500 memories - water resistant



**Art. PR20**  
**Rotella Metrica**  
**in fibra m. 20**  
 Fiber measuring tape 20 m.

**Art. PR50**  
**Rotella Metrica**  
**in fibra m. 50**  
 Fiber  
 measuring tape  
 50 m.

**Art. PR100**  
**Rotella Metrica**  
**in fibra m. 100**  
 Fiber measuring tape 100 m.

Lato A  
Side A



Lato B  
Side B



**Art. C00937**  
Segnalatore bifacciale per cambio giocatori manuale fluorescente - base in plastica lucida  
Substitution indicator fluorescent 1 piece 2 sides



● pg.20



**Art. 071** Serie numeri cambio giocatori (da 1 a 25) senza manico  
Numbers for substitution (from 1 to 25) with no handle

**Art. 072** Serie numeri cambio giocatori (da 1 a 25) con manico  
Numbers for substitution (from 1 to 25) with handle



**Art. B01084**  
Segnapunti da tavolo per calcetto  
Table scoreboard for futsal



**Art. 072-D**  
Doppia serie (rossa e verde) di numeri da 1 a 99 per sostituzione giocatori con manico (disponibile sino ad esaurimento scorte)  
Double set of numbers (red and green) from 1 to 99 for substitution, with handle (until available in stock)



## TAVOLETTE ELETTRONICHE PER SOSTITUZIONI Electronic Substitution Boards



**Art. F292-30**  
Valigetta cm. 61x40x8  
per Art. FINOUT4 e FINOUT8  
Case 61x40x8 cm. for Art. FINOUT4 and FINOUT8

### Art. FINOUT4

Tavoletta elettronica bicolore, monofacciale a 4 cifre (2+2) - led verdi per giocatore entrante led rossi per giocatore uscente, completa di caricabatteria - dim. cm. 58x38x2,7 kg. 2,2  
4 Digit Electronic Substitution Board  
1 side 2 color leds (red and green) cm.58x38x2,7  
Kg. 2,2 with battery charger

### Art. FINOUT8

Tavoletta elettronica bicolore, bifacciale a 4 cifre (2+2) - led verdi per giocatore entrante led rossi per giocatore uscente, completa di caricabatteria - dim. cm. 58x38x2,7 kg. 2,25  
4 Digit Electronic Substitution Board  
2 sides 2 color leds (red and green) 58x38x2,7  
Kg. 2,25 with battery charger

pg.20



### Art. 065-EC

Tavoletta elettronica bifacciale - bicolore  
Delta 2FE1 cm.46x33x1,8 Kg.1,3  
4 digit Electronic substitution Board  
2 sides - 2 color leds (red and green)  
battery charger included

### Art. EC-VG

Valigetta per Art. 065-EC - Bag for Art. 065-EC



### Art. 065-N

Tavoletta Elettronica Sostituzioni  
Delta F2002 monofacciale  
approvata UEFA led monocolori rossi,  
completa di valigetta e caricabatteria  
cm. 48x38,5x2 kg. 1,8

UEFA Electronic substitution Board 1 side  
1 color red leds - bag and battery charger  
included



### Art. 066

Tavoletta Elettronica Sostituzioni  
Delta FDI bifacciale  
approvata UEFA led monocolori rossi,  
completa di valigetta e caricabatteria  
cm. 48x38x4 kg. 3  
UEFA Electronic substitution Board 2 sides  
1 color red leds  
bag and battery charger included

UEFA  
APPROVED  
PRODUCTS

### Art. 065-F

Tavoletta Elettronica approvata UEFA/FIFA bifacciale,  
bicolore a 4 cifre Delta 2F - completa di valigetta e  
caricabatteria - led rossi e verdi - ufficiale Mondiali  
Sudafrica 2010 - cm. 64,5x39x2,5 kg. 3

4 digit UEFA/FIFA Electronic  
substitution Board  
2 sides - 2 color leds  
(red and green)  
bag and battery  
charger included  
(2010 FIFA World Cup  
South Africa)



## PALLONI CALCIO - Soccer Balls



**Art. GPA4 / GPA5**

**Pallone calcio Gems Viper Olimpico da allenamento in PU n.4 e n.5 vari colori**

Ball Gems in PU size 4 and 5 various colors



**Art. GPF4 / GPF5**

**Pallone calcio Gems Viper Olimpico da allenamento in PU n.4 e n.5 GIALLO FLUO**

Ball Gems in PU size 4 and 5 fluorescent yellow



**Art. GPRP4 / GPRP5**

**Pallone calcio Gems Raptor da gara in PU n.4 e n.5**

Ball Gems in PU size 4 and 5

pg.20

**New!**



**Art. GPRZX**

**Pallone calcio Gems Raptor ZX da gara FIFA Quality Pro in PU n. 5**

Ball Gems in PU size 5



**Art. NKPA4/NKPA5**

**Pallone calcio Nike Pitch Team colore bianco o arancio n. 4 e n. 5**

Nike training ball size 4 and 5



**Art. F4V1700 / F5V1700**

**Pallone calcio da allenamento Molten**

**misto PVC-PU n.4 e n.5 Molten training ball PVC/PU size 4 and 5**



**Art. F5V48TR**

**Pallone calcio Molten n.5 F5V4800 "Trofeo" per allenamento professionisti e gare ufficiali categorie inferiori**

Molten Soccer Ball F5V4800 "Trofeo" size 5



**Art. F5V4800**

**Pallone calcio Molten n.5 F5V4800**

**FIFA approved Molten Soccer Ball F5V4800 size 5**

## PALLONI CALCETTO, DA PALLEGGIO E SPECIALI - Futsal and rubber balls

**New!**



pg.22

**Art. M13189**  
Pallone Mondo n. 1  
Ball Mondo size 1



**Art. GPPC3**  
Pallone Primi Calci Gems  
in PU n. 3  
Ball Gems in PU size 3

**CALCIO  
A 8**



pg.20

**Art. GPC8**  
Pallone calcio a 8 Gems Raptor C8  
in PU n. 4,5  
Ball Gems in PU size 4,5

**New!**



**New!**

**Art. GBLD**  
Pallone calcetto Gems Blade  
a rimbalzo controllato n. 4  
Futsal Ball Gems size 4

pg.21



**New!**

**Art. GBLD.ZX**  
Pallone calcetto Gems Blade ZX  
ibrido top quality  
a rimbalzo controllato n. 4  
Futsal Ball Gems size 4

**Art. F100B**  
Pallone calcetto AGLA  
Bola F100 rimbalzo  
controllato in  
pelle sintetica  
(ad esaurimento)  
Futsal Ball  
AGLA Bola F100  
slow rebound  
in synthetic leather  
(until available)



**Art. M390P**  
Pallone calcetto Molten  
modello F9G1900  
rimbalzo controllato  
Atrax  
Molten Futsal Ball F9G1900

**Art. MTHO**  
Pallone calcetto Molten  
modello F9G4800  
rimbalzo controllato  
Thorax  
Molten Futsal Ball F9G4800



pg.21

**Art. 26854**  
Pallone calcetto feltro  
indoor n. 4  
a rimbalzo normale  
Indoor Ball size 4



**Art. 45862**  
Pallone calcetto feltro indoor  
n. 4 a rimbalzo controllato  
Indoor slow rebound Futsal Ball  
size 4



**Art. ULT46-3**  
Pallone calcetto  
gomma TRIAL triplo  
strato rimbalzo controllato  
gr.380 - diam. cm.19,9  
Futsal Ball slow rebound  
Trial rubber



pg.21

**Art. 1935S**  
**Pallone calcio in gomma**  
**misura n. 3 monostrato colore giallo**  
 Barret Rubber soccer Ball  
 size 3 single stratum  
 color yellow



**Art. 9965S**  
**Pallone calcio in gomma**  
**misura n. 4 monostrato**  
**colori rosso, bianco**  
 Rubber soccer Ball size 4 single  
 stratum  
 colors red, white



pg.22

**Art. BYCC**  
**Pallone Calcio bicolore**  
**gomma Trial Ø cm.21,5 gr. 420**  
 Trial rubber bicoloured ball



**Art. V45/V44/V42/V41/V40**  
**Palloni calcio in gomma Trial monostrato n. 1 - 2 - 3 - 4 - 5**  
 Rubber soccer Balls single stratum Trial size 1 - 2 - 3 - 4 - 5

pg.21



**Art. ULT42-3/ULT41-3/**  
**ULT40-3**  
**Palloni calcio in gomma**  
**Trial triplo strato**  
**n. 3 - 4 - 5**  
 Rubber soccer Balls  
 triple stratum Trial  
 size 3 - 4 - 5

**Art. ULTST3/ULTST4/**  
**ULTST5**  
**Palloni Trial SILVER**  
**STREET n. 3 - 4 - 5**  
**doppio strato**  
 SILVER STREET Trial balls  
 size 3-4-5 double stratum



**Art. TRILO**  
**Pallone calcio Trial**  
**TRILO 4.5 doppio**  
**strato - limita**  
**il trauma dovuto**  
**all'impatto con la palla**  
 Soccer Ball Trial TRILO  
 size 4.5 double stratum  
 softens ball contact



**Art. B703390**  
**Pallone in pelle sintetica gr.1000**  
 Training Ball  
 in synthetic leather 1000 gr.



**Art. ULTS40**  
**Pallone in gomma Trial**  
**allenamento potenziato doppio strato**  
 Ø cm.21,5 gr.630 (+50%)  
 Trial heavy rubber ball double stratum



**Art. ULTD40**  
**Pallone in gomma Trial**  
**allenamento potenziato**  
**doppio strato**  
 Ø cm.21,5 gr.840 (+100%)  
 Trial heavy rubber ball  
 double stratum

pg.22



**Art. TRBC**  
**Pallone reaction ball Trial**  
**doppio strato rimbalzo e traiettorie**  
**imprevedibili per calcio**  
 Trial Reaction Ball unpredictable rebounds  
 for soccer double stratum



**Art. B703315**  
**Pallone per allenamento portieri**  
**rimbalzo irregolare in pelle sintetica**  
 Crazy Goal-Keeper Ball  
 irregular rebounds in synthetic leather



**Art. B703316**  
**Reflex ball**  
**pallone prismatico**  
**in pelle sintetica**  
 Prismatic ball in  
 synthetic leather



**Art. 149S14**  
**Pallone in**  
**gommapiuma Ø cm. 14**  
 Foam rubber ball Ø 14 cm.

pg.21



**Art. 149S**  
**Pallone in**  
**gommapiuma Ø cm. 20**  
 Foam rubber ball Ø 20 cm.



**Art. E48**  
**Pallone sonoro Trial**  
**per non vedenti**  
 Ø cm.22 - gr.470  
 Trial rattle ball for blind people

pg.22

## PALLE MEDICHE a massa fissa e oscillante - Classic and Dynamic Medicine Balls



**New!**

Art. AHF-105 / AHF-106 / AHF-107  
AHF-108 / AHF-109

Palle Mediche  
rigonfiabili e rimbalzanti  
Kg. 1 - 2 - 3 - 4 - 5  
ad alto grip  
colore nero  
Medicine Balls  
inflatable and rebounding  
high grip in black color

pg.22



Art. 048 / 050 / 051 / 052 / 053

Palle Mediche rigonfiabili e  
rimbalzanti Trial  
kg. 1 - 2 - 3 - 4 - 5  
(il colore varia  
a seconda del peso)  
Trial Medicine Balls  
inflatable and rebounding  
different colors for different  
weights



pg.23

Art. WMD100 / WMD200  
WMD300 / WMD400  
WMD500

Palle Mediche morbide  
Bubble Trial  
kg. 1 - 2 - 3 - 4 - 5  
Soft Trial Medicine Bubble  
Balls kg. 1 - 2 - 3 - 4 - 5



**New!**

Art. AHF-048/.../AHF-097

SLAM BALL kg. 2 - 3 - 4 - 5 - 6 - 7 - 8 - 9 - 10 - 12 - 15

pg.23



**New!**

Art. AHF-117/.../AHF-125

WALL BALL kg. 3 - 4 - 5 - 6 - 7 - 8 - 9 - 10 - 12



pg.22

Art. OV500 / OV1 / OV2 / OV3 / OV4 / OV5

Over ball Trial kg.0,5 - 1 - 2 - 3 - 4 - 5 con impugnatura anatomica  
Over ball TRIAL

Art. POL1/POL1.5/POL2/POL3/POL3.5

POLIBOLO - Over ball Trial a massa oscillante (riempite con acqua distillata) peso kg.1 - 1,5 - 2 - 3 - 3,5  
POLIBOLO TRIAL - Over ball filled with distilled water  
weights 1 - 1,5 - 2 - 3 - 3,5 Kg.

Le Over ball e le Polibolo possono essere utilizzate sia come manubri sia come palle mediche  
Over Balls and Polibolos can be used both as dumb bells and medicine balls





**Super resistenti**  
Impossible to break

**Art. FLUIB05/FLUIB1/FLUIB2/FLUIB3/  
FLUIB4/FLUIB5**

pg.22

**Palle mediche FluiBall riempite con acqua demineralizzata colorata - peso kg. 0,5-1-2-3-4-5**  
FluiBall Medicine balls filled with demineralized coloured water - weight 0,5-1-2-3-4-5 Kg.

**Grazie a queste nuove palle mediche gli atleti utilizzano carichi non inerti ma dinamici, effettuando esercizi di forza coordinata nuovi e destabilizzanti. La massa oscillante all'interno della palla medica FluiBall impone, sia in fase di lancio che di carico, adattamenti muscolari e coordinativi istantanei la cui intensità è variabile, e quindi non prevedibile. Inoltre, per i più giovani le palle mediche FluiBall sono molto efficaci per la memorizzazione della tecnica e per migliorare la conoscenza ed il controllo del proprio corpo. È possibile gonfiare e sgonfiare tutte le FluiBall variandone così la sofficietà ed il rimbalzo**

The new FluiBall medicine balls allow new exercises for muscle strength, equilibrium and coordination.

The liquid inside these balls makes them dynamic weights that require new rapid and adapting movements both when throwing and when lifting. Younger players will also improve and memorize body movements enhancing their equilibrium. These balls can be inflated or deflated so that softness and rebound will change

**CALCIO - SOCCER**



**RITMICA**



**VOLLEY**



**BASKET**

**Esempi di utilizzo delle palle mediche FluiBall in combinazione con le pedane instabili (Skimmy, Meduse e Tartarughe)**

Examples of exercises you can do with FluiBall medicine balls in combination with articles C1/C2/C3/T1/T2



pg.12

**Art. KEB4/KEB6/KEB8/KEB10/KEB12/KEB16/KEB20/KEB24**

**Kettlebell in ghisa verniciata con base in gomma**

**kg. 4 - 6 - 8 - 10 - 12 - 16 - 20 - 24**

Painted cast iron Kettlebells - rubber base

## PALLE RITMICHE, PSICOMOTORIE E LUDICHE - Rhythmic and Gym Balls



pg.21

**Art. 518S/516S/510S Palle Ritmiche Mondo (sino ad esaurimento)**  
gr. 400-240-160 Mondo Rhythmic Balls (until available)

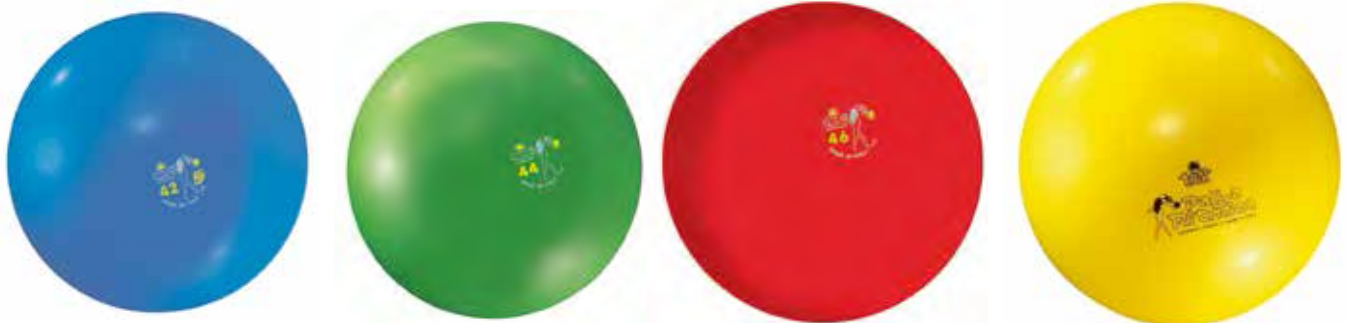

**Art. 42R/44R/46R/48R Palle Ritmiche Trial - Trial Rhythmic Balls gr. 420-320-240-150**



**Ideali per trattamento  
fisioterapico,  
equilibrio, stretching,  
tonificazione, attività  
aerobica, scarico  
vertebrale,  
riscaldamento,  
potenziamento  
muscolare ...**  
Very useful for injury  
recovery, equilibrium,  
stretching, muscle  
training, aerobic activity,  
warm up ...



**Art. 30934/30935/30936/31036**  
**Palle psicomotorie monostrato**  
Gym balls single stratum various colors  
Ø cm. 55  
Ø cm. 65  
Ø cm. 75  
Ø cm. 85

pg.23



**Art. V10/V11/V12/V13/V14/V15/  
V16/V17/V18/V19**  
**Palle psicomotorie Trial in  
gomma doppio strato  
(il colore varia  
a seconda del diametro)**  
Trial Gym balls  
in double stratum rubber  
Ø cm.14-18-22-30  
42-53-65-90-120-150

**Art. V-LAB**  
**Palla psicomotoria Trial La Ball  
con range di possibile utilizzo  
da cm.50 a cm.70**  
**struttura instabile in gomma doppio  
strato particolarmente elastica**  
Gym ball Trial La Ball  
inflatable from 50 to 70 cm.  
changing shape concept in very elastic  
double stratum rubber





**Palloni Linea Sun: Ø cm. 26 peso gr. 320 Ø 26 cm. weight 320 grams**

**Il diametro maggiorato favorisce l'apprendimento del bambino - Bigger diameter for youngest training and fun**



**Art. AL01 Big Sun**  
Fase di volo più lenta  
Slower in the air



**Art. AL02 Foot Sun**  
Per stimolare la tattilità del bambino  
To stimulate children's touch



**Art. AL03 Crazy Sun**  
Cambia direzione ad ogni rimbalzo  
Irregular rebounds

pg.22



**Art. ULTbbs3**  
Pallone Jumbo Trial a 3 strati  
diam. cm.28 - gr.280  
Jumbo Trial Ball triple stratum



**Art. BTR1**  
Palla sensoriale Ø cm. 21 - gr. 420  
Sensory Ball Ø cm.21 - gr. 420

Le palle sensoriali rimbalzanti esaltano la tattilità e rappresentano anche uno strumento di automassaggio a pressione  
To stimulate touch and also useful massage tools



**Art. BTR2**  
Palla sensoriale Ø cm.12 - gr. 180  
Sensory Ball Ø cm.12 - gr. 180

pg.21

Allenando la visibilità laterale migliorano la percezione dello spazio, i movimenti e la sicurezza nella vita quotidiana  
For space perception, coordination and everyday life safety

pg.8



**Art. TLV16**  
Palle morbide Trial per allenamento della visibilità laterale Set di 6 Palle diametro cm. 16 gr. 110  
Soft balls for lateral visibility training Set of 6 balls 16 cm. diameter - 110 gr.

**Art. TLV21**  
Set di 6 Palle diametro cm. 21 gr. 160  
Soft balls for lateral visibility training Set of 6 balls 21 cm. diameter - 160 gr.



**Art. BS1T**  
PALLONE BASIC jelly touch Ø 12/16 cm. gr.140 - colore verde  
Basic Ball green color

pg.22

**Art. BS2T**  
PALLONE BASIC jelly touch Ø 16/22 cm. gr.180 - colore arancio  
Basic Ball orange color

**Art. BS3T**  
PALLONE BASIC jelly touch Ø 22/28 cm. gr.240 - colore rosso  
Basic Ball red color

## BORSE - Bags

**\*\* VERIFICARE MINIMI D'ORDINE SUL LISTINO PREZZI \*\***  
Minimum required quantity shown on price list

**COLORI DISPONIBILI**  
Art. TOM/TON:  
rosso, royal, navy,  
nero, verde, amaranto  
Colors: red, royal, black,  
green, navy, amaranthine

**Art. TOM**  
Borsa Grande cm 53x32x45  
poliestere 600  
Soccer bag large



**Art. TON**  
Borsa Media  
cm 47,5x26,5x40  
poliestere 600  
Soccer bag  
medium



**Art. E**  
Zainetto doppio fondo poliestere 600  
3 tasche - cm.35x23x45 fondo rigido  
colori: royal, nero, rosso,  
navy, verde, bordeaux

pg.24



**Art. PRE**  
Borsa Premier in poliestere 600  
con fondo rigido h. 15 cm. con tracolla e porta nome,  
tre tasche, dim. cm. 53x32x50  
colori: navy-royal, nero/grigio, navy/rosso,  
nero/verde, navy/giallo  
Soccer Bag Premier in polyester 600 3 pockets size 53x32x50 cm.  
colors:navy/royal, black/gray, navy/red, black/green, navy/yellow

**Art. ZMAS**  
Zainetto  
cm. 35x23x47  
con fondo rigido  
4 tasche poliestere 600  
5 combinazioni di colori  
(come borsa Premier Art. PRE)  
Rucksack in 5 different colors  
(same like Premier bag Art. PRE)

**\*\* VERIFICARE MINIMI D'ORDINE SUL LISTINO PREZZI \*\***  
Minimum required quantity shown on price list



**Art. TOBPL**

Borsa palestra poliesteri 600 cm. 50x30x28  
con tracolla imbottita, lastra rigida sul fondo, 3 tasche  
colore nero, navy  
Gym Bag colors black, blue



**Art. TOBPM**

Borsa Portamute cm.80x40x40  
nylon 420 - colore navy o nero  
Soccer bag for uniforms dim. 80x40x40 cm.  
color: black or navy

**Art. TOTRO**  
Trolley professional in rip-stop 600  
2 tasche, tracolla, porta nome, fondo rigido  
rivestito dim. cm.62x34x52  
colore navy, nero  
Trolley colors black, blue



pg.24



**Art. ZBGL**

BORSA/ZAINETTO monocolori economica  
cm. 36x38 vari colori - serigrafabile su richiesta  
Backpack one color  
with logo on request



**Art. TBMD**

Borsa Medica dim. cm. 48x18x32  
poliesteri 600  
Bag for First Aid 48x18x32 cm.



**Art. BMD**

Borsa Medica dim. cm. 37x29x17  
Bag for First Aid 37x29x17 cm.

## CESTE PORTAPALLONI - Baskets for balls



**Art. FP400**  
Cesta portapalloni in alluminio  
pieghevole con sacca  
Basket for balls in aluminium,  
foldable with bag



**Art. F401**  
Cesta Portapalloni in ferro verniciato  
cm. 80 x 55 x 60h pieghevole  
Basket for Balls in painted steel 80 x 55 x 60h cm. foldable



pg.24

**Art. F402**  
Cesta Portapalloni  
in ferro zincato  
cm. 60 x 60 x 90h pieghevole  
Basket for Balls  
in galvanized steel  
60 x 60 x 90h cm. foldable

**Art. F404** Cesta  
Portapalloni  
in rete metallica  
verniciata  
dim. cm. 70x70x70  
pieghevole  
con lucchetto  
Basket for Balls painted  
with metallic net  
70x70x70 h cm.  
foldable, with lock



**Art. F403G** Cesta Portapalloni  
in ferro verniciato cm. 100 x 75 x 90h.  
pieghevole con lucchetto  
Basket for Balls in painted steel  
100 x 75 x 90h cm. foldable, with lock



**Art. F403ZN**  
Cesta Portapalloni in ferro zincato  
cm. 100 x 75 x 90h.  
pieghevole con lucchetto  
Basket for Balls in galvanized steel  
100 x 75 x 90h cm. foldable, with lock



**Art. NCPR**  
Cesta portapalloni in nylon  
con maniglie, tracolla e ruote  
Bag for balls with handles and wheels



## PORTE CALCIO - Soccer Goals



pg.25

**Art. 109**  
Coppia Porte fisse regolamentari in lega leggera costruite secondo lo standard europeo di qualità UNI EN 748 con paletti tendirete posteriori in acciaio, pali sezione mm. 120x100 verniciati con smalto acrilico non tossico, ganci reggirete e bossole per interrimento pali incluse (telaio posteriore di appoggio a terra non incluso)  
Pair of regular Goals in light alloy manufactured according to the UNI EN 748 European standard of quality norms.  
Pipe section 120x100 mm. painted with non toxic white.  
Net holders, rear posts and underground bases included (ground backframes not included)

**Art. 109.G**  
Coppia ribaltine posteriori alzarete per porte Art. 109 e S109  
Pair of liftable ground backframes for Goals Art. 109 and S109 (to keep nets down to the ground and also to raise them up when cutting grass)

**Art. SPP45**  
Set 4 protezioni imbottite h. cm. 200 per paletti posteriori tendirete  
Set of 4 soft protections 200 cm. height for net holder posts

**Art. MBR15**  
Set protezioni imbottite rinforzate per coppia ribaltine alzarete  
Set of thick soft protections for pair of ground backframes

**Art. SPR45**  
Set protezioni imbottite per coppia ribaltine alzarete  
Set of soft protections for pair of ground backframes

**ATTENZIONE: in caso di ordine errato da parte del Cliente le porte, una volta consegnate, non possono essere sostituite**

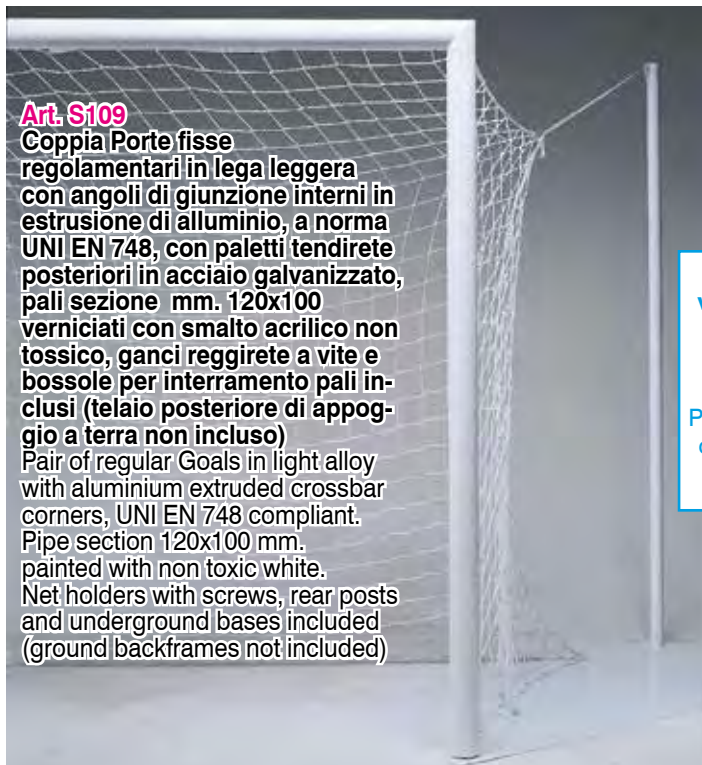

**Art. S109**  
Coppia Porte fisse regolamentari in lega leggera con angoli di giunzione interni in estrusione di alluminio, a norma UNI EN 748, con paletti tendirete posteriori in acciaio galvanizzato, pali sezione mm. 120x100 verniciati con smalto acrilico non tossico, ganci reggirete a vite e bossole per interrimento pali inclusi (telaio posteriore di appoggio a terra non incluso)  
Pair of regular Goals in light alloy with aluminium extruded crossbar corners, UNI EN 748 compliant.  
Pipe section 120x100 mm. painted with non toxic white.  
Net holders with screws, rear posts and underground bases included (ground backframes not included)

pg.25

**Art. 353.G13 / 353.G10**  
Serie 100 ganci reggirete di ricambio modello a rotazione per porte regolamentari o ridotte

100 spare Net Holders rotating model for regular and reduced goals  
2013 or 2010 shape has to be specified

**ATTENZIONE:**  
verificare la tipologia dei ganci delle Vs. porte prima di ordinare i ricambi  
Please check the model of your holders before ordering spares



pg.27

**Art. 353.G13**



**Art. 353.G10**



**Art. 353 Serie 100 ganci reggirete di ricambio modello con vite per porte regolamentari o ridotte**  
100 spare Net Holders with screws for regular and reduced goals

pg.27



**Art. V590010**  
Serie 100 ganci reggirete di ricambio  
100 spare Net Holders



**Art. 110BAG**  
Serie 60 ganci reggirete di ricambio  
60 spare Net Holders



**Art. 110FG - Coppia Porte Trasportabili in lega leggera dimensioni regolamentari profilo sezione mm. 120x100 verniciate con smalto acrilico non tossico base di appoggio posteriore con tubo tondo in ferro - a norma UNI EN 748**  
 Pair of transportable Goals in light alloy regular size, pipe section mm. 120x100 painted with non toxic white - back frame in round iron pipe - UNI EN 748 standard



**Art. 120-RG**  
**Coppia ruote per porte trasportabili regolamentari Art. 110FG, 110-D e 110G**  
 Pair of wheels for regular size transportable goals  
 Art. 110FG, 110-D and 110G



pg.25

**LE PORTE TRASPORTABILI IN FASE DI GIOCO DEVONO ESSERE ZAVORRATE SULLA BASE POSTERIORE O FISSATE A TERRA CON PICCHETTI PER MOTIVI DI SICUREZZA. LE RUOTE GOMMATE SONO OPTIONAL**

Transportable goals must always be anchored to the ground by sacs of sand or metal pegs, for safety reasons. Wheels are optional

**Art. 110-D**  
**Coppia Porte Trasportabili dim. regolamentari in lega leggera profilo sezione mm. 120x100 - verniciate con smalto acrilico non tossico base di appoggio posteriore con profilo ovale in alluminio mm. 65x55 - a norma UNI EN 748**  
 Pair of transportable Goals in light alloy regular size, pipe mm. 120x100 painted with non toxic white - back frame in aluminium ovoidal pipe 65x55 mm.



**Art. AMCP**

**Carrello per il trasporto di porte (trasportabili) regolamentari e ridotte - brevettato**  
 Patented trolley for moving official and junior size transportable goals

pg.27



**Art. 110G** - Coppia Porte Trasportabili in lega leggera dimensioni regolamentari profilo mm. 120x100 verniciate con smalto acrilico non tossico, base di appoggio posteriore con profilo in lega mm. 120x100 - a norma UNI EN 748 e FIGC  
 Pair of transportable Goals in light alloy regular size, pipe mm. 120x100, painted with non toxic white - back frame pipe 120x100 mm. - UNI EN 748 and FIGC standard

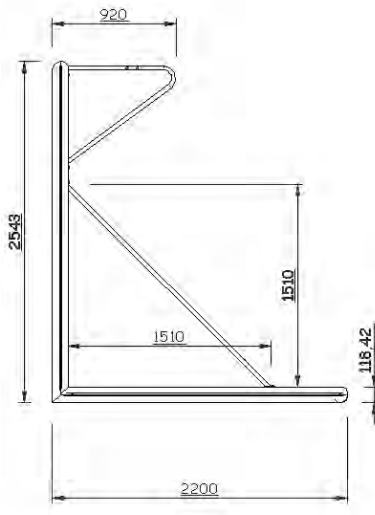

pg.25

**Art. 120-RG**  
 Coppia ruote per porte trasportabili regolamentari Art. 110FG, 110-D e 110G  
 Pair of wheels for regular size transportable goals Art. 110FG, 110-D and 110G



**Art. 4580M**  
 Mollone per ancoraggio porte trasportabili regolamentari e ridotte su terreno naturale  
 Spring for goal anchoring on natural grass

pg.25

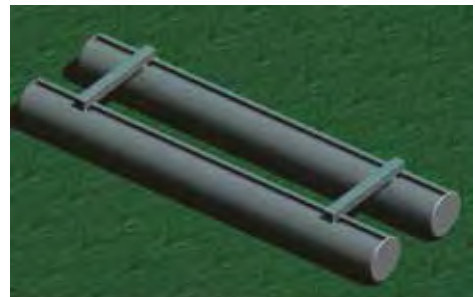

**Art. AFC**  
 Zavorra in alluminio per ancoraggio porte trasportabili regolamentari e ridotte  
 Aluminium weighted pipes for goal anchoring

**Art. DSSCE**  
 Sacco zavorra vuoto (da riempire con sabbia) per ancoraggio porte trasportabili regolamentari e ridotte  
 Empty Ballast Bag (to be filled with sand) for goal anchoring



**Art. DSS20**  
 Sacco zavorra kg. 20 (riempito con sabbia) per ancoraggio porte trasportabili regolamentari e ridotte  
 Ballast Bag weight 20 Kg. for goal anchoring

pg.27

**Porte fisse (con bossole e pali da interrare) e trasportabili in lega leggera o acciaio, sezione tubo mm. 120x100 o mm.80 - dimensioni m. 3x2 - m. 4x2 - m. 5x2 - m. 6x2**

Fixed and transportable Goals in light alloy or painted steel, pipe section 120x100 mm. or 80 mm. dimensions m. 3 x 2 - m. 4 x 2 - m. 5 x 2 - m. 6 x 2

pg.26



Art. 114-T  
Art. 118-G  
Art. 116-TDV  
Art. 120-TG

**Con distanziale a terra posteriore in tubo tondo**  
With round pipe ground base

**Art. 114-T**

**Coppia Porte m. 4 x 2 a traversa intera in acciaio trasportabili tubo sezione 80 mm.**  
Pair of Goals m. 4 x 2 - 1 piece crossbar in painted steel, transportable, pipe 80 mm.

**Art. 118-G**

**Coppia Porte m. 4 x 2 a traversa intera in lega di alluminio trasportabili tubo sezione 80 mm.**  
Pair of Goals m. 4 x 2 - 1 piece crossbar in light alloy, transportable, pipe 80 mm.

**Art. 116-TDV**

**Coppia Porte m. 5 x 2 a traversa divisa in lega di alluminio trasportabili tubo 80 mm.**  
Pair of Goals m. 5 x 2 - crossbar in 2 pieces in light alloy, transportable, pipe 80 mm.

**Art. 120-TG**

**Coppia Porte m. 6 x 2 a traversa divisa in lega di alluminio trasportabili tubo sezione 80 mm.**  
Pair of Goals m. 6 x 2 - crossbars in 2 pieces in light alloy, transportable, pipe 80 mm.

**Art. 118A**  
**Coppia Porte m. 4 x 2 a traversa divisa in lega di alluminio trasportabili tubo 80 mm. con basi posteriori in profilo quadro**  
Pair of Goals m. 4 x 2 - crossbars in 2 pieces in light alloy, transportable, pipe 80 mm. with square pipe ground bases

**Art. 1129A**  
**Coppia Porte m. 5 x 2 a traversa divisa in lega di alluminio trasportabili tubo 80 mm. con basi posteriori in profilo quadro**  
Pair of Goals m. 5 x 2 - crossbars in 2 pieces in light alloy, transportable, pipe 80 mm. with square pipe ground bases

**Art. 1121A**  
**Coppia Porte m. 6 x 2 a traversa divisa in lega di alluminio trasportabili tubo 80 mm. con basi posteriori in profilo quadro**  
Pair of Goals m. 6 x 2 - crossbars in 2 pieces in light alloy, transportable, pipe 80 mm. with square pipe ground bases



Art. 118A  
Art. 1129A  
Art. 1121A

Base posteriore a sezione quadro  
Reinforced ground base

Scegliere reti con profondità posteriore bassa cm. 160  
Pick nets with depth 160 cm. at ground level

**LE PORTE TRASPORTABILI IN FASE DI GIOCO DEVONO ESSERE ZAVORRATE SULLA BASE POSTERIORE O FISSATE A TERRA CON PICCHETTI PER MOTIVI DI SICUREZZA. LE RUOTE GOMMATE SONO OPTIONAL**

Transportable goals must always be anchored to the ground by sacs of sand or metal pegs, for safety reasons. Wheels are optional



**Art. 120-R**

**Coppia ruote per porte trasportabili ridotte Art. 118A, 1129A, 1121A**  
Pair of wheels for reduced size transportable goals Art. 118A, 1129A, 1121A

pg.27



**Art. 4640**

**Coppia ruote per porte trasportabili ridotte Art. 114-T, 118-G, 116-TDV, 120-TG**  
Pair of wheels for reduced size transportable goals Art. 114-T, 118-G, 116-TDV, 120-TG



Le porte ridotte sono disponibili anche nel modello fisso con pali e bossole da interrare  
Available also fixed models with underground bases





**Art. 119G**  
**Art. 120-G**

Scegliere reti con profondità  
posteriore bassa cm. 160  
Pick nets with depth 160 cm. at ground level



**Art. 240RU**



**Art. 240AF**



**Art. 241C**

pg.26

**Art. 119G Coppia Porte m. 5 x 2 a traversa divisa in acciaio trasportabili tubo 80 mm.**

Pair of Goals m. 5 x 2 crossbar in 2 pieces in painted steel, transportable, pipe 80 mm.

**Art. 120-G Coppia Porte m. 6 x 2 a traversa divisa in acciaio trasportabili tubo sezione 80 mm.**

Pair of Goals m. 6 x 2 crossbars in 2 pieces in painted steel, transportable pipe 80 mm.

**Art. 240RU Coppia ruote gommata con staffa per porte Art. 119G/120-G** Pair of wheels for transportable goals Art. 119G/120-G

**Art. 240AF Kit di fissaggio a terra per porte Art. 119G/120-G** Ground anchoring kit for transportable goals Art. 119G/120-G

**Art. 241C Chiave per kit di fissaggio Art. 240AF** Key for ground anchoring kit Art. 240AF

**Art. 122G**  
**Coppia Porte Calcio trasportabili m. 3 x 2 in acciaio verniciato tubo sezione 80 mm.**  
Pair of Goals m. 3 x 2 transportable in painted steel pipe 80 mm.

pg.27

**Art. 121G**  
**Coppia Porte Calcio trasportabili m. 3 x 2 in lega leggera tubo sezione 80 mm.**  
Pair of Goals m. 3 x 2 transportable in light alloy pipe 80 mm.



**Art. 122G**

**Art. 121G**

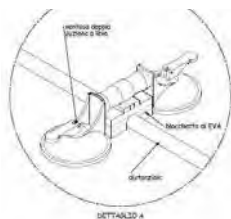

**Art. VTCL**  
**Ventosa doppia per ancoraggio a terra porte calcetto su superfici indoor lisce (si consigliano 2 kit per ciascuna porta)**  
Ground anchoring suckers for reduced goals to be used upon indoor smooth floors (it takes 2 kits for every goal)

pg.27



**Art. DSSCE**  
**Sacco zavorra vuoto (da riempire con sabbia) per ancoraggio porte trasportabili regolamentari e ridotte**  
Empty Ballast Bag (to be filled with sand) for goal anchoring



**Art. DSS20**  
**Sacco zavorra kg. 20 (riempito con sabbia) per ancoraggio porte trasportabili regolamentari e ridotte**  
Ballast Bag weight 20 Kg. for goal anchoring

**Art. PC04**  
**Picchetto in alluminio per ancoraggio a terra su terreno naturale di porte ridotte con distanziale sottile**  
Aluminium anchoring hook for reduced soccer goals with thin pipe ground bases

**Art. AM01.7/.../AM01.3**  
**TUBO ZAVORRA in PVC diametro 50 mm. atossico, flessibile, modellabile, appesantito da composto ecologico (peso 6 Kg. per metro) resistente alle alte e basse temperature e ai raggi ultravioletti per porte ridotte mt. 3x2/4x2/5x2/6x2 e regolamentari sia fisse che trasportabili**  
Weighted soft Pipe 50 mm. diameter (6 Kg. per meter) resistant to low temperatures and ultra violet rays for safe anchoring of transportable goals m. 3x2/4x2/5x2/6x2 and official size goals to the ground

pg.27





pg.27

Ideali per uso  
privato  
Not for official  
matches

**Art. SG176**  
**Porta m. 3x2 trasportabile**  
**in ferro verniciato,**  
**tubo sezione mm. 32**  
**completa di rete, ganci e**  
**picchetti**

3x2 meter transportable  
Goal in painted iron, pipe  
section 32 mm. complete  
with net, hooks and pegs

**PORTE BIFRONTALI in lega leggera o acciaio dimensioni m. 3x2 - 4x2 - 6x2**  
Available 2 SIDE GOALS in light alloy or in painted steel dimensions m. 3 x 2 - 4 x 2 - 6 x 2

pg.27



**Art. 084**  
**Porta bifrontale**  
**m. 4 x 2**  
**in lega leggera**  
**sezione tubo 50 mm.**  
**completa di rete**  
Two Side Goal  
4 x 2 m. in light alloy  
pipe 50 mm.  
net included

**Art. 084AC**  
**Porta bifrontale**  
**m. 4 x 2**  
**in acciaio verniciato**  
**sezione tubo 50 mm.**  
**completa di rete**  
Two Side Goal  
4 x 2 m. in painted  
steel, pipe 50 mm.  
net included



pg.28



**Art. IS215**  
**Miniporta in acciaio m. 2,15 x 1,52 completa di rete, parete con bersagli e rete di rimbalzo**  
Steel Mini-goal m. 2,15 x 1,52 net, PVC target and rebounding net included

## PORTE E MINIPORTE FLESSIBILI - Flexible goals and mini-goals



**New!**

### Art. FLEX1.5

Porta minicalcio m. 1,5 x 0,90 flessibile con struttura in vetroresina, completa di rete e picchetti - peso Kg. 3,50 tempo di assemblaggio 1 minuto

Flexible fiberglass Mini-Goal size 1,5x0,9 mt. with net and pegs - weight 3,5 Kg. set up time 1 minute

pg.28

**Art. FLEX.3**  
Porta calcetto m.3x2 flessibile con struttura in vetroresina, completa di rete e picchetti peso Kg.12,5 tempo di assemblaggio 2 minuti  
Flexible fiberglass Futsal Goal size 3x2 mt. with net and pegs - weight 12,5 Kg. set up time 2 minutes



pg.28

### Art. S.BAGS

Coppia di sacchi zavorra da riempire con sabbia per l'ancoraggio degli Art. FLEX1.5 e FLEX.3 su terreni sintetici

Pair of sand bags (sand not included) for anchoring Art. FLEX1.5 and Art. FLEX.3 on turf or synthetic grass

- Velocissime da assemblare
- I montanti in vetroresina flettono e tornano immediatamente in posizione al momento del goal o dell'impatto con la palla
- Facili da smontare e trasportare
- Leggerezza e minimo ingombro

- Quick set up
- Fiberglass poles flex and pop up straight after goal
- Easy to take down and carry
- Low weight and volume



### Art. FLEX7

Porta calcio regolamentare flessibile con struttura in vetroresina completa di rete e base di appoggio autoportante, utilizzabile sia su terreni naturali che sintetici

(non necessita dell'utilizzo di zavorre) tempo di assemblaggio 5 minuti in 2 persone  
Flexible fiberglass official size Goal with net, ready for use on grass or turf (sand bags not required) set up time 5 minutes 2 people

## MINI PORTE Mini-goals



**Art. F214**  
Coppia Miniporte professionali  
in acciaio verniciato tubo sezione 80 mm.  
dimensioni m. 1,5 x 1 complete di reti  
Pair of professional steel Mini-goals  
pipe 80 mm. dimensions m. 1,5 x 1  
nets included



pg.28

**Art. F218**  
Coppia Miniporte professionali  
in acciaio verniciato  
tubo sezione 80 mm.  
dimensioni cm. 90x60  
complete di reti

**New!**

Pair of professional steel Mini-goals  
pipe 80 mm.  
dimensions 90x60 cm.  
nets included



**Art. 123C**

Coppia Miniporte in acciaio verniciato m. 1,5 x 1  
complete di reti e picchetti  
Pair of Mini-goals m. 1,5 x 1  
in painted steel pegs and nets included



**Art. 123F**

Coppia Miniporte in acciaio verniciato  
m. 1,5 x 1 complete di reti e picchetti  
Pair of Mini-goals m. 1,5 x 1 in painted steel  
pegs and nets included

pg.28



**Art. 124C**

Coppia Miniporte m. 1,5 x 1,1 in PVC rinforzato tubo Ø 70 mm. complete di reti e picchetti  
Pair of PVC Mini-goals m. 1,5 x 1,1 pipe Ø 70 mm. pegs and nets included

**New!**



**Art. PUG**  
**Coppia Miniporte in nylon**  
**m. 1,83 x 1,07**  
**complete di reti,**  
**picchetti e borsa**  
Pair of nylon Mini-goals  
1,83 x 1,07 m.  
nets, pegs and bag included

pg.28

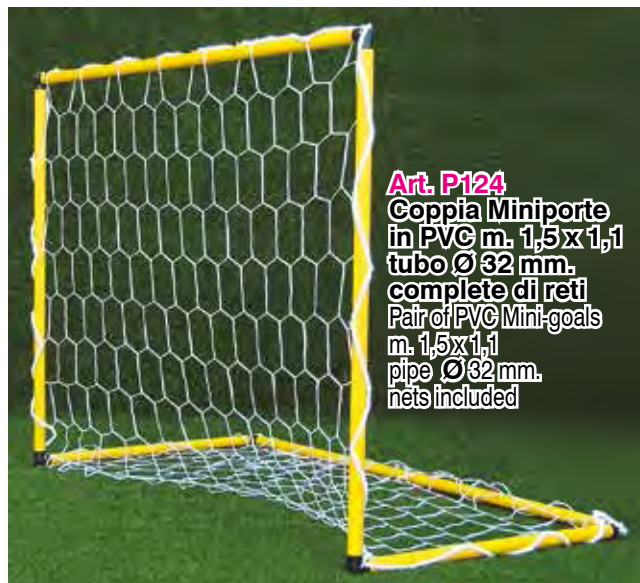

**Art. P124**  
**Coppia Miniporte**  
**in PVC m. 1,5x1,1**  
**tubo Ø 32 mm.**  
**complete di reti**  
Pair of PVC Mini-goals  
m. 1,5x1,1  
pipe Ø 32 mm.  
nets included



**Art. 124** Coppia Miniporte in  
polipropilene  
m. 1,5x1,1 tubo Ø 40 mm.  
complete di reti  
Pair of polypropylene Mini-goals  
m. 1,5x1,1 pipe Ø 40 mm.  
nets included



pg.28

**Dimensioni porte ribaltate**  
**m. 1,5 x 0,80**  
Goal upside down  
dimensions 1,5 x 0,80 m.



**Art. A124**  
**Coppia Miniporte in alluminio m. 1,5 x 1,1**  
**tubo Ø 32 mm. complete di reti**  
Pair of aluminium Mini-goals m. 1,5 x 1,1  
pipe Ø 32 mm. - nets included



**Dimensioni Porta ribaltata m. 1,5 x 0,80**  
Goal upside down dimensions 1,5 x 0,80 m.

## RETI REGOLAMENTARI - Regular Nets



**\*Le reti a maglia esagonale sono tessute, quelle a maglia quadrata sono annodate**

**\*Square mesh nets are knotted**



**Art. 125E**

polipropilene sp. mm. 3  
**profondità cm.170x170 depth**

● pg.28

● pg.29



**Art. 125**

polipropilene sp. mm. 4  
**profondità cm.170x170 depth**



**Art. 126**

poliestere sp. mm. 5  
**profondità cm.100x200 depth**



**Art. 127**

polipropilene sp. mm. 5  
**profondità cm.200x200 depth**



**Art. B19**

polietilene sp.mm.3,5  
**profondità cm.100x200 depth**



**Art. 128E**

polietilene sp.mm.3,5  
**profondità cm.170x170 depth**



**Art. 128**

polietilene sp.mm.4,5  
**profondità cm.200x200 depth**



**Art. B011** polipropilene sp.mm.5  
maglia mm.120 mesh  
colori: bianco, rosso, verde, blu e nero white, red, green, blue or black  
certificate FIGC/LND certified  
**profondità cm.200x200 depth**



**Art. 128FR** Coppia reti annodate in polietilene sp.mm.4 bianche o a strisce colorate (bianco-royal, bianco-rosso, giallo-royal) **profondità cm.100x200 depth**  
Pair of nets polyethylene 4 mm. color stripes, knotted (available in white, white-royal, yellow-royal, white-red)



**Art. 128C** Coppia reti annodate in polietilene sp.mm.3,5 a strisce colorate (bianco-royal, bianco-rosso, giallo-royal, rosso-blu, bianco-nero, bianco-verde) **profondità cm.200x200 depth**  
Pair of nets polyethylene 3,5 mm. color stripes, knotted (available in white-royal, yellow-royal, white-red, white-black, white-green, red-blue)



**Art. 129T**  
Coppia reti polipropilene sp. mm. 6 annodate a mano a strisce colorate (consigliabile per combinazioni di colori alternative a quelle degli Art.128FR e 128C) **profondità cm.200x200 depth**  
Pair of nets with color stripes, hand knotted in various combinations

## RETI RIDOTTE - Reduced Size Nets



**Art. 131.5**  
Coppia Reti Pair of Nets  
m. 6,50 x 2,50  
Polipropilene sp. mm. 4

**Art. 133**  
Coppia Reti Pair of Nets  
m. 4 x 2  
Polipropilene sp. mm. 4

**Art. 133SN / 132N / 131N**  
Coppia Reti Pair of Nets  
**annodate**  
m. 4x2 - 5x2 - 6x2  
knotted  
polietilene sp. mm. 2,5

● pg.29



**Art. 131.22 / B170 / B171**  
Coppia Reti Pair of Nets  
**annodate** m. 6x2,20 - 6x2 - 5x2  
knotted polietilene sp. mm. 3,5



**Art. 133LR / 133NP**  
Coppia Reti Pair of Nets  
**annodate** m. 4x2  
knotted polietilene sp. mm. 3,5  
prof. cm.100x100/cm.100x160 depth

## RETI CALCETTO - Futsal Nets m. 3x2



**Art. 134E**  
polietilene  
**annodate** knotted  
sp. mm. 2,5

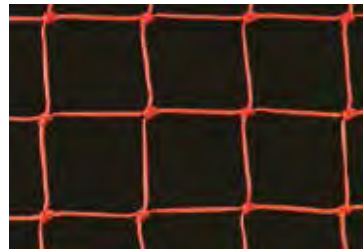

**Art. 135**  
polietilene sp. mm. 4,5 **annodate** knotted  
**rosse, bianche o gialle**  
red, yellow or white



● pg.29



**Art. 135C**  
polietilene **annodate** knotted  
**colore bianco** sp. mm. 3,5  
color white



**Art. 135FR**  
polietilene **annodate** knotted  
**colori: bianco-royal, bianco-rosso, giallo-royal** sp. mm. 3  
colors: royal/white, red/white, yellow/royal

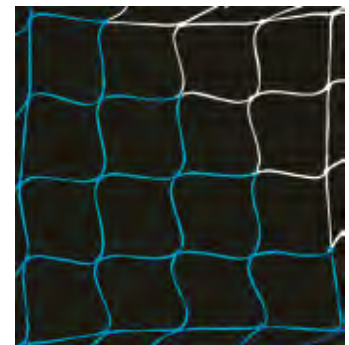

**Tasche**  
Pockets

**Tasche**  
Pockets

● pg.29

**Art. GM** Rete respingente con 4 tasche per tiri di precisione completa di corda elastica e picchetti (da applicare a porta regolamentare)

Special nets with 4 accuracy pockets including elastic rope and pegs for regular size goal

*Basta raccogliere palloni in fondo al sacco, lascia che sia la palla a tornare da te!*  
*Stop picking up balls all the time, let the ball come back to you!*

## RETI DI PROTEZIONE - Protection nets



**\* TUTTE LE RETI DI PROTEZIONE VENGONO REALIZZATE SU MISURA IN BASE ALLE RICHIESTE DEL CLIENTE in circa 10 giorni**

\* All protection nets are manufactured according to Customer's needs in about 10 days time

pg.30

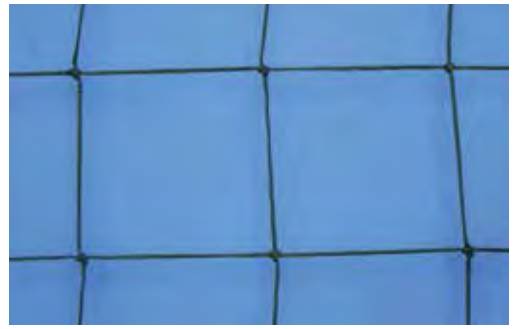

**Art. 093N**

**Rete protezione polietilene verde annodata maglia cm. 13x13 sp. mm.2,5 per calcio e calcetto**

Protection Net green polyet. mesh 13x13 cm. knotted, thickness 2,5 mm.



**Art. 093.5**

**Rete protezione polietilene verde cm. 13x13 annodata sp. mm.3,5 per calcio e calcetto**

Protection Net green polyethylene mesh 13x13 cm. knotted, thickness 3,5 mm.

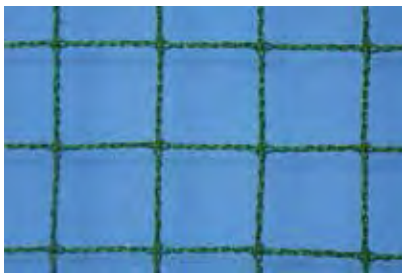

**Art. 0934LR**

**Rete protezione polietilene verde maglia mm. 45x45 sp. mm.2 (per tennis e baseball)**  
Protection perimetric Net for tennis and baseball

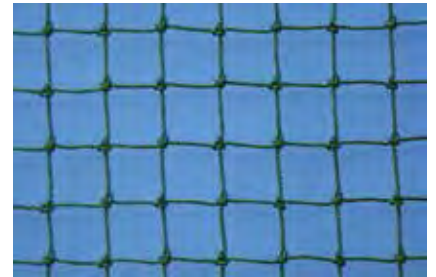

**Art. R57**

**Rete protezione polietilene verde maglia mm.25x25 sp. mm.3 (per golf)**  
Protection perimetric Net for Golf

**Art. R55**  
**Rete protezione polietilene nera maglia mm.18 annodata sp. mm.2 antioggetto e antipetardo**  
Protection Perimetric Net anti-objects and fire crackers

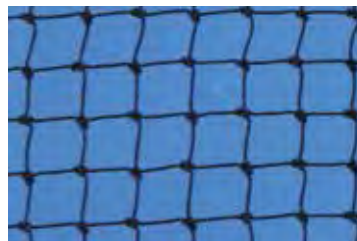

## RETI PORTAPALLONI - Ball sacs



**Art. 041-6 / 041-12 / 041-18**  
**S041-6 / S041-12 / S041-18**

**Reti Portapalloni in polipropilene con o senza nodo**  
**(da 6/12/18 palloni)**

Nets for Balls in polypropylene knotted or not (6/12/18 balls)

pg.30

**Art. SM20**  
**Sacca Portapalloni in nylon 420/PVC capienza 20 palloni**  
Ball Sac for 20 balls





## PANCHINE ALLENATORI - Trainers' dug-outs



Panchina allenatori profilo curvato mm 50x30 in acciaio zincato a caldo  
**Art. V6230 e seguenti**  
rivestimento posteriore in policarbonato alveolare non trasparente spessore mm 4, fianchi rivestiti in policarbonato trasparente mm 3, piano di seduta in scocche di polipropilene montate su telaio zincato

Altezza tettuccio cm. 200, profondità fianco laterale cm. 88

● pg.31

Panchina allenatori profilo curvato mm 50x30 in acciaio zincato a caldo  
**Art. V6220 e seguenti**  
rivestimento posteriore e laterale in policarbonato trasparente spessore mm 3, piano di seduta in scocche di polipropilene montate su telaio zincato



**Art. V6285**  
Protezione in poliuretano espanso per bordo panchina allenatori profilo mm. 50x30

**Art. V6288**  
Coppia ruote da applicare a panchina profilo 50x30 al fine di renderla trasportabile





Altezza tettuccio cm. 200 profondità fianco laterale cm. 74  
Roof height 200 cm. - side depth 74 cm.

**Art. 155AV/156AV/157AV/158AV/159AV/159.8AV/155AV4**

**Panchina con struttura in tubo quadro in lega d'alluminio mm. 30x30 con copertura in policarbonato alveolare non trasparente - fianchi laterali in policarbonato trasparente (2 scocche di seduta in polipropilene per ogni metro di lunghezza)**

Dug-out in light alloy square pipe mm. 30x30 with non transparent alveolar protection  
Transparent protection on both sides (2 polypropylene seats per every meter of length)

pg.32

*È possibile sostituire le scocche con le panche a listoni in legno con schienale senza variazioni di prezzo  
Available wooden benches with back in spite of seats, at the same price*



*È necessario fissare le panchine su una base in cemento tramite tasselli: la base dovrà essere più estesa di circa 30 cm. per ciascun lato rispetto alla lunghezza e alla profondità della panchina.  
It is necessary to anchor dug-outs upon concrete base. Size of concrete base must be about 60 cm. longer and deeper than dug-out perimetric size (30 cm. longer and wider on each of the 4 sides)*



Altezza tettuccio cm. 200 profondità fianco laterale cm. 74  
Roof height 200 cm. - side depth 74 cm.

**Art. 155/156/157/158/159/159.8/155-4**

**Panchina con struttura in tubo quadro in lega d'alluminio mm. 30x30 con copertura in policarbonato trasparente e scocche di seduta in polipropilene (2 scocche di seduta per ogni metro di lunghezza)**  
Dug-out in light alloy square pipe mm. 30x30 with transparent polycarbonate protection  
(2 polypropylene seats per every meter of length)

pg.31

*La verniciatura con colore a richiesta del tubo quadro in alluminio comporta una maggiorazione del prezzo del 10%*  
*Optional painting of the square pipe frame in aluminium (color on request): 10% additional charge on selling price*

*È possibile sostituire le scocche con le panche a listoni in legno con schienale senza variazioni di prezzo*  
*Available wooden benches with back in spite of seats, at the same price*



**Art. ASBI**  
**Scocca ricambio per panchina allenatori colore rosso o blu, fissaggio con 4 viti**  
Spare Seat for Dug-Outs in red or blue color, fixing with 4 screws

pg.32

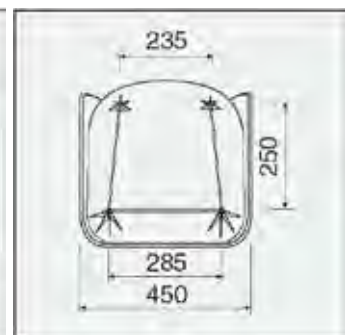
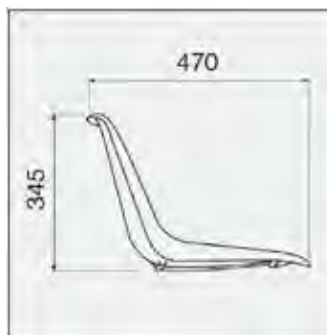

*È necessario fissare le panchine su una base in cemento tramite tasselli: la base dovrà essere più estesa di circa 30 cm. per ciascun lato rispetto alla lunghezza e alla profondità della panchina*  
*It is necessary to anchor dug-outs upon concrete base. Size of concrete base must be about 60 cm. longer and deeper than dug-out perimetric size (30 cm. longer and wider on each of the 4 sides)*

## PANCHINE LUSO - Luxury dug-outs



### Art. 155FZ2/155FZ4/155FZ6/155FZ8

**Panchina allenatori in acciaio zincato a caldo rinforzato profilo mm. 40x40 con profondità cm.180 (misurando da tettuccio a limite base posteriore di appoggio)**

**Rivestita con lastre in policarbonato trasparente spessore mm. 3.**

**Piano di seduta in scocche in polipropilene Mondo Seat 6**

Dug-Out in galvanized steel pipe 40x40mm. - 180 cm. depth (from back protection to edge of roof)  
Transparent polycarbonate 3mm. thick back cover - Polypropylene seats on steel frame (2 seats each meter)



● pg.32

### Art. 155PR

**Rivestimento di protezione in schiumato per tettuccio e montanti**  
Soft edge protections



### Art. LXR2/LXR4/LXR6/LXR8

**Panchina allenatori in tubo di acciaio zincato a caldo profilo mm. 40x40 TRASPORTABILE su ruote - Copertura in policarbonato trasparente profondità cm. 135**

**Piano di seduta in scocche in polipropilene Mondo Seat 6**

Dug-Out in galvanized steel pipe 40x40 mm. - TRANSPORTABLE on wheels  
transparent polycarbonate back cover polypropylene seats

## PANCHINE LUSO CON SEDUTE IN ECOPELLE - Leather seat dug-outs



**New!**



**PREVENTIVO SU RICHIESTA  
PRICES ON REQUEST**

**Modelli fissi o trasportabili  
struttura in acciaio zincato  
poltrone in ecopelle personalizzabili**  
Fixed or transportable Dug-Outs  
galvanized steel frame  
customized leather seats



## PANCHINE ALLENATORI IDEALI PER CAMPI CALCETTO Trainers' dug-outs for futsal pitches



Panchina allenatori profilo curvato  
mm 40x20 in lega di alluminio  
rivestimento posteriore e laterale  
in policarbonato alveolare sp. mm. 4  
profondità a terra cm. 97,  
altezza massima cm. 208  
lunghezza metri 2 oppure metri 3  
con panca sedute  
in acciaio zincato e legno  
**Art. V6242.2 e Art. V6242.3**  
o con panca sedute  
in alluminio anodizzato  
(come raffigurato nelle immagini)  
**Art. V6241.2 e Art. V6241.3**

● pg.33



Dug-out curved profile  
40x20 mm in light alloy  
rear and side coverings  
in non transparent polycarbonate  
4 mm. thick  
soil depth. 97 cm.  
maximum height 208 cm.  
2 meters or 3 meters length  
with wooden bench on  
galvanized steel  
**Art V6242.2 and V6242.3**  
or with bench in  
anodized aluminium  
(as shown in pictures)  
**Art V6241.2 and V6241.3**

## PANCHINE ALLENATORI IDEALI PER CAMPI CALCETTO Trainers' dug-outs for futsal pitches



Panchina allenatori trasportabile su ruote - profilo curvato mm 50x30 in lega di alluminio rivestimento posteriore e laterale in policarbonato alveolare sp. mm. 4 **Art. V6291** oppure in policarbonato trasparente sp. mm. 3 **Art. V6292** profondità a terra cm. 150, altezza utile cm. 210 lunghezza metri 3 con supporto sedute in acciaio zincato e 6 scocche in polipropilene con piano borse sul retro dei seggiolini

pg.33

Dug-out transportable on wheels curved profile 50x30 mm in light alloy rear and side coverings in non transparent polycarbonate mm. 4 thick **Art V6291** or in transparent polycarbonate mm. 3 thick **Art V6292** depth on the ground 150 cm. useful height 210 cm. length 3 meters with galvanized steel seat support and 6 polypropylene seats with back space for bags



**Art. S04910**  
Panchina bordo campo struttura in acciaio zincato lunghezza cm. 200 con 4 scocche di seduta in polipropilene colorato  
4 Sideline seats on galvanized steel frame length 200 cm.

pg.45

## CARRELLI TRACCIALINEE - Line markers



pg.30

Per una resa ottimale  
e per evitare inconvenienti  
utilizzare sempre carbonato di calcio,  
cioè la comune polvere di marmo

**Art. 142S**  
**Carrello traccialinee  
a polvere**  
Marble Powder Line Marker

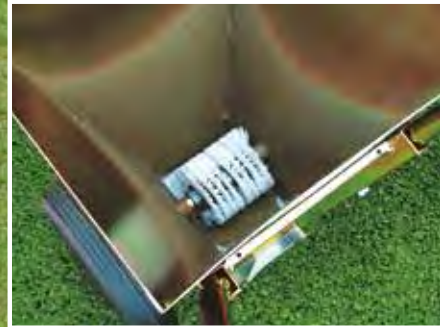

**UTILIZZARE SOLTANTO  
VERNICE ECOLOGICA  
ATOSSICA E PULIRE DOPO  
OGNI USO IL  
SERBATOIO E TUTTO IL  
CIRCUITO DI SPRUZZO  
SINO AGLI UGELLI  
(occorre spruzzare  
ripetutamente acqua  
prima di riporre l'attrezzo)**  
Always use ecological paint and  
wash with water after use  
(put water in the tank and spray)

**Nuove ruote  
antifango  
in dotazione  
new anti-mud  
wheels**

**Art. 144**  
**Carrello traccialinee  
a vernice ecologica  
con serbatoio munito di  
pompa a pressione  
manuale**  
Paint Line Marker,  
with manual pressure tank



pg.30

Particolare  
leva pressione  
spruzzo

**Art. 145**  
**Carrello traccialinee  
a vernice ecologica  
con motore a scoppio  
a miscela  
serbatoio vernice lt.25  
tracciatura laterale regolabile**  
Paint Line Marker  
with 2 stroke engine  
25 liter tank



**Art. 144.EL**  
**Carrello traccialinee  
a vernice elettrico  
completo di caricabatteria  
(per la batteria della pompa  
elettrica)  
capacità serbatoio litri 18  
tracciatura laterale regolabile**  
Electric Line Marker  
complete with battery charger  
18 liter tank  
adjustable lateral marking device



● pg.30

**Art. 144.SL**  
**Carrello traccialinee a rulli  
senza serbatoio a pressione né motore  
a scoppio. Tramite la rotazione  
dei rulli, la vernice viene prelevata  
all'interno del serbatoio e spalmata  
sull'erba.**

Roller Paint Line Marker  
Just fill up the tank with paint  
and push the machine.  
Taking advantage of rolling wheels,  
paint flows from tank down to grass  
the easiest way!



**Art. 146**

**Vernice Ecologica atossica per manti erbosi Linea Stadio**  
lt. 15 - Kg. 19 ad alto rendimento  
Ecological Paint for grass 15 liters - 19 Kg.



**Art. 146E**

**Vernice Ecologica atossica per manti erbosi Biancostadio** lt. 17 - Kg. 19  
Ecological Paint for grass 17 liters - 19 Kg.

pg.30



**Art. 3MT**

**Rotolo Nastro adesivo mt. 50 - h. 5 cm.**  
vari colori per tracciatura righe su superfici sintetiche  
Tape for bounds  
50 meter - 5 cm. height

**Art. SIFS**

**Fettuccia segnasettore in materiale sintetico impermeabile colore bianco o rosso**  
larghezza mm. 50 in rotoli da m. 25 (chiodi inclusi)

Sector line in waterproof synthetic fabric, width 50 mm. length 25 m. color white or red (pegs included)

pg.31



**Art. 146BP**

**Vernice bianca o gialla per manti sintetici a bassa permanenza (1 settimana)**  
17 litri, da utilizzare preferibilmente con carrello a rulli  
Paint for artificial grass white or yellow color, short durability (1 week) 17 liters



**Art. 146LP**

**Vernice bianca o gialla per manti sintetici a lunga permanenza (3 mesi)**  
17 litri, da utilizzare solo con carrello a rulli  
Paint for artificial grass white or yellow color, long durability (3 months) 17 liters



**Art. ELP2/ELP4**

**Elasticone per divisione spazi h. cm. 2 oppure h. cm. 4**  
lunghezza mt. 20, completo di 2 moschettoni  
Elastic bound 2 cm. height or 4 cm. height - length 20 meters - with 2 hooks



pg.31

**Art. NS200**

**Rotolo nastro stradale mt. 200 - bianco/rosso**  
Red/White Tape length 200 meters



pg.30

**Art. PFIx Plifix**

**Picchetto di riferimento permanente con erba sintetica bianca o colorata, per agevolare la tracciatura delle righe dei campi di gioco o per delimitazione aree**  
Confezione da 25 pezzi  
utensile in plastica incluso  
Plifix - permanent peg with artificial white or colored grass to help tracing lines on the field or mark areas  
25 pieces set includes also plastic planting device



pg.12

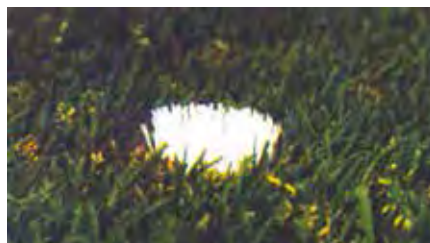

## SCOCHE PER GRADINATE - Stadium seats

**COLORI DISPONIBILI: blu, rosso, giallo, verde, bianco, nero, grigio**  
**AVAILABLE COLORS: blue, red, yellow, green, white, black, grey**

pg.33

**ORDINE MINIMO 10 PEZZI PER MODELLO E COLORE**  
**Minimum quantity 10 pieces per model and color**

**ATTENZIONE:  
 NON PER PANCHINE  
 ALLENATORI!  
 NOT FOR TRAINERS'  
 DUG-OUTS!**



**Art. M2003**

**Art. M2003** Scocca in polipropilene con schienale ignifuga e antiultravioletti (secondo normativa UEFA) fissaggio diretto sulla gradinata con tasselli (non inclusi)  
 Polypropylene Seat non ignitable and anti-ultraviolet rays with back rest (according to UEFA requirements) to be fixed with screws (not included)

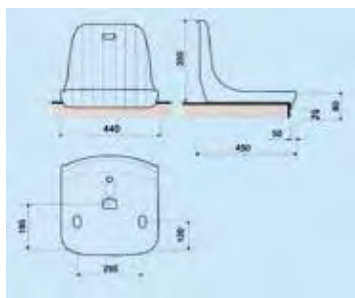
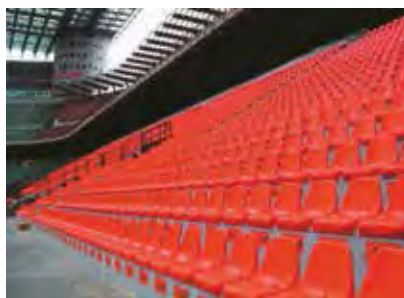

**Art. M2003A** Scocca in polipropilene antiultravioletti con schienale, fissaggio diretto sulla gradinata con tasselli (non inclusi)  
 Polypropylene Seat anti-ultraviolet rays, with back rest to be fixed with screws (not included)

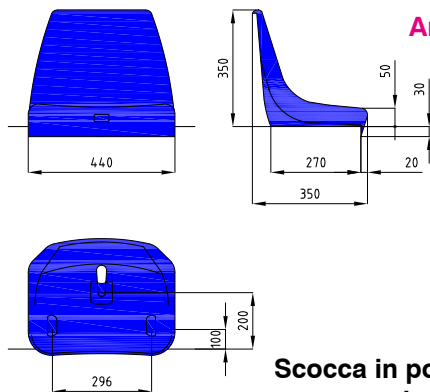

**Art. M2008**



**Scocca in polipropilene con schienale ignifuga e antiultravioletti Art. M2008 oppure solo antiultravioletti Art. M2008A - fissaggio diretto sulla gradinata con tasselli (non inclusi)**

Polypropylene Seat non ignitable and anti-ultraviolet rays **Art. M2008** or only anti-ultraviolet rays **Art. M2008A** with back rest to be fixed with screws (not included)

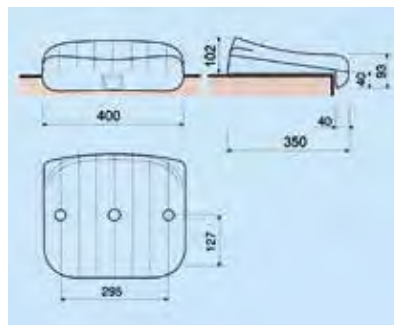
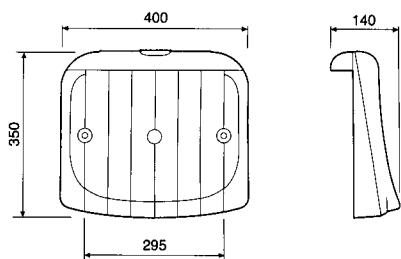

**Art. M90**

**Art. M90**

**Scocca in polipropilene ignifuga e antiultravioletti - senza schienale fissaggio diretto sulla gradinata con tasselli (non inclusi)**

Polypropylene Seat non ignitable and anti-ultraviolet rays, without back rest - to be fixed with screws (not included)

**Art. M90.A**

**Scocca in polipropilene antiultravioletti - senza schienale fissaggio diretto sulla gradinata con tasselli (non inclusi)**

Polypropylene Seat anti-ultraviolet rays, without back rest - to be fixed with screws (not included)

## TRIBUNE - Stands



### Art. G12005

**Modulo Tribuna per interno/esterno su 3 file in acciaio zincato trasportabile su ruote, piani di seduta in carply, lunghezza m. 2,5**  
Indoor/outdoor Stand in galvanized steel, 3 rows, movable on wheels, with wooden benches



pg.34



### Art. G12006

**Modulo Tribuna per interno/esterno su 3 file in acciaio zincato trasportabile su ruote, piani di seduta con scocche in polipropilene, lunghezza m. 2,5**  
Indoor/outdoor Stand in galvanized steel, 3 rows, movable on wheels, with polypropylene seats



**Art. G120TM**  
**Tribuna telescopica da interno**  
**con scocche in polipropilene M90**  
Telescopic Stand for indoor  
with M90 polypropylene seats

● pg.34



**Art. CTMB1** ● pg.33  
**Cuscino per tribuna pieghevole**  
**rivestito in nylon**  
**colori blu o rosso, bordo nero**  
Foldable seat Cover - color blue or red



**Art. S07700**  
**Transenna in acciaio zincato**  
**cm. 200x100h.**  
Galvanized steel barrier

● pg.34



**Art. S07710**  
**Transenna in plastica cm. 215x90h. con piedi di appoggio**  
**a terra ruotabili, con banda catarifrangente e sistema di**  
**aggancio a catena**  
Plastic barrier 215x90 cm.

## ARREDI PER SPOGLIATOIO - Dressing Room Benches



Altre lunghezze disponibili: m. 1 e m. 1,5  
Also available: length 1 and 1,5 meters

Profondità seduta cm. 35  
altezza massima cm. 185  
Depth 35 cm.  
height 185 cm.



### Art. S07310

Panca con schienale, appendiabiti e portaborse in acciaio verniciato con listoni in legno lunghezza m. 2

Complete Bench in painted steel and wood length m. 2

### Art. S07320

Tavola attaccapanni con tettuccio lunghezza m. 2  
Top side only in painted steel and wood length m. 2

Art. S07314  
Panca completa doppia per centro stanza m. 2 in acciaio verniciato con listoni in legno  
Double bench in painted steel and wood length m. 2



pg.34

ALTRI ARTICOLI SUL LISTINO PREZZI



### Art. S07306

Panca in acciaio verniciato con listoni in legno m. 2 con schienale

Bench in painted steel and wood length m. 2 with back rest

Altre lunghezze disponibili: m. 1 e m. 1,5  
Also available: length 1 and 1,5 meters



### Art. S07302

Panca in acciaio verniciato con listoni in legno m. 2

Bench in painted steel and wood length m. 2

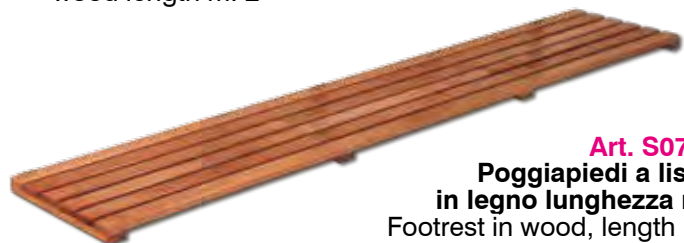

### Art. S07404

Poggiapiedi a listoni in legno lunghezza m. 2  
Footrest in wood, length m. 2

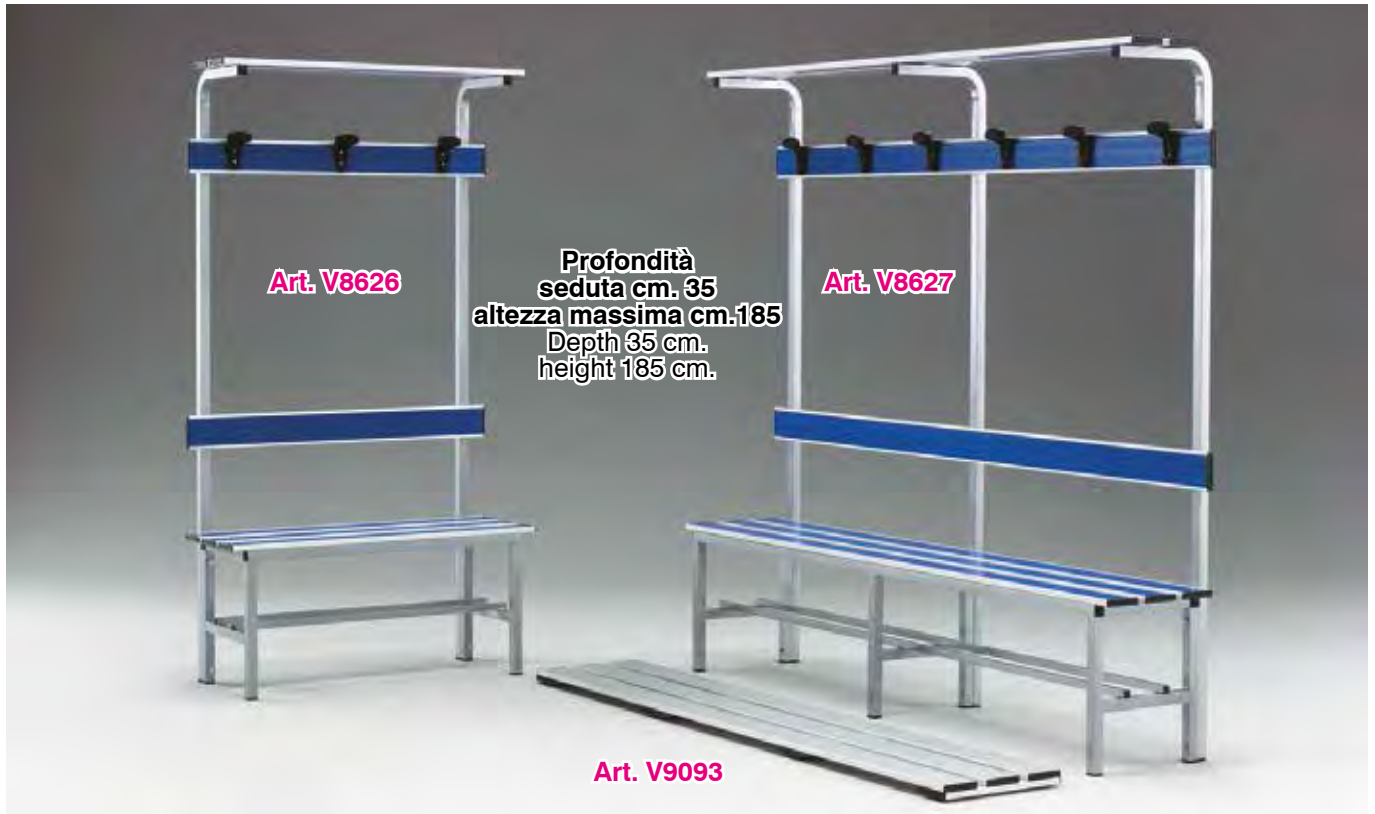

**Art. V8626**

**Profondità  
seduta cm. 35  
altezza massima cm.185  
Depth 35 cm.  
height 185 cm.**

**Art. V8627**

**Art. V9093**

**Panca con schienale, appendiabiti e portaborse in alluminio anodizzato con inserti in PVC lunghezza m. 1 Art. V8626 oppure lunghezza m. 2 Art. V8627**  
Complete Bench in anodized aluminium length m. 1 **Art. V8626** or length m. 2 **Art. V8627**

**Pedana poggiapiedi in alluminio anodizzato lunghezza m. 1 Art. V9092 oppure lunghezza m. 2 Art. V9093**  
Footrest in anodized aluminium length 1 or 2 meters

pg.34

pg.35

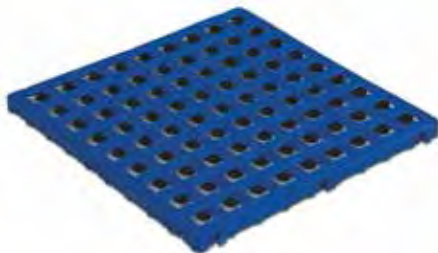

**Art. S07408**  
**Pedana poggiapiedi in plastica cm. 50x50**  
Plastic footrest 50x50cm.



**Art. S07434**  
**Graticcio per doccia in legno cm. 60x60**  
Wooden footrest 60x60cm.



**Art. S07466**  
**Asciugacapelli elettrico con temporizzatore e tubo flessibile**  
Hair dryer with timer and flexible pipe



**Art. TPD Poggiapiedi Footsy idrorepellente**  
Foldable foot rest waterproof



**Art. S07458**  
**Asciugamani elettrico con temporizzatore**  
Hand dryer with timer

**ALTRI ARTICOLI SUL LISTINO PREZZI**

pg.35



**Art. S07462**  
**Asciugacapelli elettrico con temporizzatore**  
Hair dryer with timer

## ARMADIETTI PER SPOGLIATOIO Dressing Room Lockers



**Art. S07226**  
Armadio spogliatoio  
a 15 posti in lamiera verniciata  
dimensioni totali  
overall dimensions  
cm. 103Lx35px180h

pg.36



**Art. MAP30**  
Armadio portavalori a 30 sportelli  
dim. cm. 50hx95Lx20p con serrature  
Safe-deposit locker with 30 boxes

**Art. MAP50**  
Armadio portavalori a 50 sportelli  
dim. cm. 82hx95Lx20p con serrature  
Safe-deposit locker with 50 boxes



Armadietti in laminato - HPL panels

**Art. S07252 / S07254 / S07256**  
Armadio spogliatoio in laminato  
dim. vano cm.30Lx50px90h.  
1 colonna 2 vani  
2 colonne 4 vani  
3 colonne 6 vani  
Laminated Lockers

**Art. S07258 / S07260 / S07262**  
Armadio spogliatoio in laminato  
dim. vano cm.30Lx50px180h.  
1 colonna 1 vano  
2 colonne 2 vani  
3 colonne 3 vani  
Laminated Lockers





**Art. S07448**  
**Specchio a parete**  
**con cornice in plastica**  
**diam.cm.60**  
Wall mirror with frame  
diameter 60 cm.

**Art. S07438**  
**Distributore di sapone**  
**liquido a parete**  
Wall soap dispenser



**Art. S07442**  
**Distributore di salviette a parete**  
Wall towel dispenser

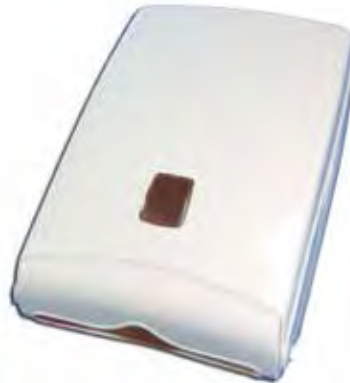

ALTRI ARTICOLI SUL  
LISTINO PREZZI



**Art. S07412**  
**Tavolo per**  
**spogliatoio e**  
**locale arbitri**  
**cm. 100x70x76**  
Locker room  
table  
100x70x76 cm.

pg.35



**Art. S07416** **Bacheca**  
**con struttura in alluminio cm. 120x90**  
Bulletin Board

**Art. S07414**  
**Sedia in acciaio cromato**  
**scocca in polipropilene**  
Chromed steel chair  
with polypropylene seat



**Art. S07418**  
**Portaombrelli a 24 posti**  
**in acciaio verniciato**  
Steel umbrella stand



**Art. S07715** **Spazzolone**  
**per pulizia e asciugatura**  
**area pubblica e campo di gioco**  
Scrubber for cleaning playground

## ACCESSORI PER SPOGLIATOIO E INFERMERIA Dressing room and infirmary accessories



**Art. S07102 / S07104**  
**Armadio a vetri a una o due ante**  
Glass Cabinet with one or two doors



**Art. S07106** **Paravento a tre ante**  
**struttura in acciaio cromato**  
Three shutter foldable screen



**Art. S07138**  
**Cassetta medica secondo D.M. 388**  
First aid kit

ALTRI ARTICOLI SUL  
LISTINO PREZZI

pg.35

pg.36



**Art. S07128**  
**Scaletta scendiletto**  
**in acciaio cromato**  
Bedside step



**Art. S07124**  
**Sgabello girevole**  
**in alluminio**  
Turnable stool



**Art. S07108**  
**Appendiabiti a colonna**  
**in acciaio cromato**  
Clothes stand



**Art. S07132**  
**Cestino in plastica**  
Plastic trashcan

**Art. S07130**  
**Portarifiuti**  
**a pedale**  
**in acciaio**  
**verniciato**  
Metal trashcan



**Art. S07134**  
**Barella pieghevole**  
**in acciaio cromato**  
Foldable Stretcher in  
chromed steel

**Art. S07110**  
**Scrivania con cassettera**  
**dim. cm.130x76x78**  
Desk with 3 drawers dimensions 130x76x78 cm.



**Art. S07114**  
**Sedia imbottita, in acciaio cromato** Chair in chromed steel



**Art. S07410**  
**Tavolo per massaggi in acciaio imbottito in similpelle**  
Massage table

pg.35

pg.36

**Art. PBN**  
**Bilancia pesapersona con statimetro**  
Scales with height measurer



**Art. 3031S**  
**Lettino Antero chiudibile**  
**testiera regolabile**  
**cm.180x60x73**  
**peso Kg.20**  
**colore nero**  
**in acciaio cromato**  
Medical couch foldable in chromed steel

**Art. 3033S**  
**Borsone porta lettino Antero**  
Bag for Art. 3031S

**Art. S07118**  
**Portarotolo**  
Paper roll holder

**Art. S07120**  
**Rotolo carta**  
Roll of paper



**Art. S07116**  
**Lettino visita medica imbottito con testiera reclinabile**  
Medical couch in chromed steel, padded, adjustable headrest

## TUNNEL USCITA SPOGLIATOI - Stadium tunnels



**Art. 160 Tunnel estensibile struttura in lega d'alluminio, copertura in PVC ignifugo Cl.2 bianca o colorata, montato su ruote in nylon, dimensioni standard (personalizzabili): larghezza cm.200, altezza al centro cm.235, in moduli da un metro**

Extensible Tunnel in light alloy covered by fireproof PVC Cl.2, white or colored, movable on nylon wheels - Standard dimensions 200 cm. width - 235 cm. height in the middle, made of 1 meter segments joined together



**\* Lunghezza, larghezza  
e altezza  
personalizzabili su richiesta**  
\* Any dimension available  
on request

## BEACH SOCCER

pg.28

**Art. PBST Coppia Porte Beach Soccer m.5,5x2,2  
in lega d'alluminio - tubo sezione 80 mm.  
verniciate di giallo**

Pair of Beach Soccer goals in aluminium  
5,5x2,2 meters  
pipe 80 mm - painted yellow



**Art. 110BS**

**Coppia Porte Beach Soccer m.5,5x2,2  
in lega d'alluminio  
tubo sezione 120x100 mm.  
verniciate di giallo**

Pair of Beach Soccer goals in aluminium  
5,5x2,2 meters  
pipe 120x100 mm - painted yellow



**Art. 073BS**  
Kit 10 paletti  
completi  
per Beach Soccer  
(6 bandierine rosse  
e 4 bandierine gialle)  
Beach Soccer  
Kit of 10 Poles  
(6 red flags and 4 yellow flags)



**Art. RBS Coppia reti per porte  
Beach Soccer m. 5,5x2,2  
in polipropilene**

Pair of polypropylene nets for  
Beach Soccer goals 5,5x2,2 meters



**Art. KDBS**

**Kit Delimitazione per campo Beach Soccer, colore  
blu: 2 nastri m. 28 + 2 nastri m. 37 da mm. 80  
+ 8 picchetti e 8 elastici**  
Kit for Beach Soccer bounds



**Art. ISBS**  
**Pallone Beach Soccer  
Gems Fiji**  
in pelle sintetica  
Beach Soccer Ball  
in synthetic leather



**Art. ULT45**  
**Pallone Beach  
Soccer Trial in gomma  
doppio strato**  
Trial Beach Soccer Ball  
double stratum rubber

## TAVOLI CALCETTO - Soccer tables

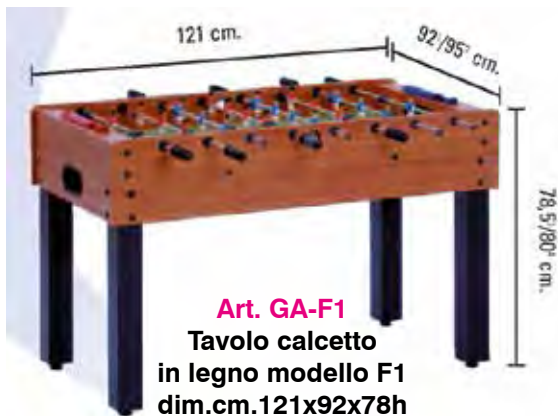

**Art. GA-F1**  
Tavolo calcetto  
in legno modello F1  
dim.cm.121x92x78h  
aste telescopiche  
ideale per bambini  
Soccer table model F1  
very good for children

**New!**



**Art. JKS300**  
Tavolo calcetto  
senza gettoniera,  
aste telescopiche,  
piano in laminato plastico,  
peso kg. 66  
Soccer table JKS300  
telescopic, weight 66 Kg.



**Art. IS432**  
Confezione 10 palline per  
tavolo calcetto  
10 Soccer table balls

pg.47

**New!**



**Art. JKS400**  
Tavolo calcetto  
senza gettoniera,  
aste telescopiche,  
piano in vetro temperato,  
peso kg. 67,5  
Soccer table JKS400  
telescopic, weight 67,5 Kg.



Modello Pride

**Art. FTGO.G**  
Tavolo calcetto modello Pride con  
gettoniera, aste cromate telescopiche,  
gambe in ferro verniciato, piano in  
multistrato, peso kg. 73  
Soccer table model Pride with coin slot  
telescopic, legs in painted steel, weight  
73 Kg.

**Art. FTEC**  
Tavolo calcetto modello Pride  
con vetro protettivo  
ad alta resistenza, peso kg. 85  
Model Pride with high resistance safety  
glass, weight 85 kg.

Da esterno



**Art. MPW**  
Tavolo calcetto da esterno  
Master Pro Weatherproof  
aste rientranti, gambe pieghevoli  
Soccer table for outdoor

## BASKET



**Art. 0873**  
**Impianto basket monotubolare zincato con sbalzo mt. 2,20 completo di tabelloni in resina melaminica, canestri e retine**  
Basketball monotubular system galvanized with boards for outdoor



**Art. BG2235**  
**Coppia protezioni imbottite per impianto basket monotubolare h. cm. 200**  
Pair of soft protections for Art. 0873



**Art. V4248**  
**Impianto basket monotubolare trasportabile tabelloni in legno sbalzo cm.165 canestri e retine**  
Monotubular transportable basketball system

**Art. V4500**  
**Impianto basket come Art. V4248 zincato e con tabelloni in resina melaminica**  
Monotubular transportable galvanized basketball system boards in resin for outdoor



**Art. V4267**  
**Set protezioni con pannello in legno rivestito in PE sp. mm. 20**  
Pair of soft protections for Art. V4248

pg.36



**Art.0857/0862/0858/0863**  
**Impianto basket a traliccio zincato, sbalzo mt.2,20 fisso o mobile su ruote completo di contenitori in bilaminato o in resina melaminica, canestri e retine**  
Basketball system in galvanized steel, with wooden or outdoor boards, fixed or transportable models

**Art. B2084**  
**Coppia protezioni imbottite per impianto basket a traliccio dim. cm.200x130**  
Pair of soft protections for basketball system dimension 200x130 cm.



**Art. S04056 / S04058**  
**Impianto basket a muro fisso con sbalzo cm. 185 oppure cm. 325, tabelloni in bilaminato, canestri e retine**  
 Wall basketball system projection 185 or 325 cm. wooden boards, rings and nets



**Art. S04151**  
**Impianto minibasket a muro fisso, sbalzo cm. 80, tabelloni in bilaminato canestri e retine**  
 Wall mini-basketball system projection 80 cm.



**Art. S04152**  
**Impianto minibasket a muro fisso, sbalzo cm. 185 tabelloni in bilaminato canestri e retine**  
 Wall mini-basketball system projection 185 cm.

pg.36

pg.37



**Art. S04150**  
**Impianto basket/minibasket a muro regolabile in altezza con canestro e retina**  
 Wall basketball/mini-basketball system adjustable height



**Art. 0986**  
**Impianto minibasket fisso a colonna zincato altezza regolabile tabellone in plastica canestro e retina**  
 Mini-basketball system galvanized steel post, adjustable height, plastic backboard, ring and net

**Art. S04161**  
**Coppia strutture minibasket agganciabili a tabelloni basket complete di tabelloni in bilaminato, canestri e retine (attrezzo per sollevamento tabelloni Art. S04162 non incluso)**  
 Pair or mini-basketball constructions to be attached to basketball backboards (rising tool Art. S04162 not included)



**Art. S04162**





**Art. 0987**  
**Impianto minibasket a colonna regolabile in altezza e trasportabile, fornito con canestri e retine**  
 Transportable mini-basket system

pg.37

**Art. S04012**  
**Struttura basket e minibasket richiudibile e trasportabile in acciaio verniciato, base porta zavorra, tabellone in resina, canestro fisso e retina, protezione frontale**  
 Transportable and foldable Basket/Minibasket in painted steel, resin board, front protection



**Art. 45097**  
**Micro tabellone con palla**  
 Wall micro board with ball

**New!**



**Art. 647B** Minibasket a colonna regolabile in altezza da cm. 168 a cm. 229 trasportabile, con canestro e retina tabellone cm. 90x60  
 Minibasket adjustable height from 168 cm. to 229 cm. transportable



**Art. 26760**  
**Tabellone minibasket da fissare al muro, fornito con canestro e retina**  
 Wall minibasket board



**Art. 26759**  
**Basket a colonna regolabile in altezza da cm. 229 a cm. 305 trasportabile, con canestro e retina tabellone cm.120x70 - rinforzato**  
 Basket adjustable height from 229 cm. to 305 cm. transportable



**Art. PPV01**  
**Protezione monotubolare singola in nylon idrorepellente con velcro cm. 180x9x2 per Art. 647B e Art. 26759**  
 Single monotubular soft protection for Art. 647B and Art. 26759



**Art. F102**  
**Canestro Basket regolamentare**  
 (retina esclusa)  
 Basket standard



**Art. B030**  
**Coppia Retine in nylon**  
 mm.3,5  
 Pair of nets mm.3,5



**Art. F103**  
**Canestro Basket rinforzato**  
 (retina esclusa)  
 Basket reinforced



**Art. B060**  
**Coppia Retine in cotone**  
 mm. 7  
 Pair of nets mm.7



**Art. F105**  
**Canestro Basket zincato**  
 (retina esclusa)  
 Basket galvanized



**Art. R122**  
**Coppia Retine in acciaio**  
 Pair of steel nets



**Art. F106**  
**Canestro Basket reclinabile, a norme FIBA**  
 (retina esclusa)  
 Reclining Basket



**Art. S04236**  
**Canestro Basket reclinabile, omologato a norme FIBA (retina esclusa)**  
 Approved reclining Basket

**Art. NRG C**  
**Set 12 ganci reggirete in plastica per canestro basket**  
 Set 12 plastic basket net holders

pg.37

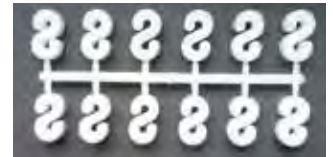

**Art. S04202 / S04214 / S04204 / F116/B / S04216**  
**Coppia tabelloni in bilaminato per interno oppure in resina melaminica per esterno - varie dimensioni**  
 Pair of basketball boards in chipboard for indoor or in resin for outdoor - various sizes

**Brevettato**  
**Patented**

**Art. F109**  
**Canestro Basket reclinabile frontalmente e lateralmente (retina esclusa)**  
 Front/Side reclining Basket



**Art. S04206 / S04208**  
**Coppia tabelloni in Plexiglass trasparente oppure cristallo temperato dimensioni cm. 180 x 105 - compreso telaio e protezione**  
 Pair of basketball boards in transparent acrylic or tempered glass 180 x 105 cm. mounted onto varnished steel frame with pads

**Art. B2063B / B2063**  
**Coppia Protezioni sottocanestro omologate FIBA e non**  
 Pair of soft board protection pads FIBA approved or not



**Art. S04266**  
**Protezione mobile per tavolo giuria e atleti in policarbonato trasparente**  
 Transparent movable polycarbonate protection for benches and referees' table

**Art. S04254**  
**Panca per atleti e riserve con poggiaschiena m.3**  
 Bench length 3 meter with back rest



**Art. S07518** pg.48  
**Elemento di separazione e protezione bordo campo**  
 cm. 200x50x75h.  
 in gomma espansa rivestita in PVC  
 Rubber bound for floor delimitation size 200x50x75h. cm.



**Art. S04256**  
**Tavolo giuria**  
 cm. 160x80x76h.  
 Referee table



**Art. KBVS**  
**Kit braccia verticali per sagoma gonfiabile Art. SAG205**  
 Raised arms kit for inflatable mannequin Art. SAG205



**Art. F255**  
**Freccia indicatrice elettronica possesso palla**  
 Electronic ball possession indicator

pg.37 pg.38



**Art. S04258**  
**Tavolo giuria**  
 cm. 240x90x76h.  
 Referee table



**Art. S04262**  
**Tavolo giuria cm. 300x70x76h. carenato su ruote**  
 Referee table on wheels

**Specifico per il Basket, il kit si installa facilmente sulla sagoma (non inclusa) e rende possibile una moltitudine di esercizi tecnico-tattici**  
 Designed for Basket training, this kit is easily installed on the dummy (not included) and makes lots of technical and tactical exercises possible



**Art. S04288**  
**Freccia indicatrice possesso palla**  
 Ball possession arrow



**Art. F254**  
**Segnalatore time out con impugnatura**  
 Time out indicator



**Art. CR016**  
**Cronometro contasecondi da tavolo a pila con display digitale**  
 Digital Table Clock for basketball



**Art. CR005**  
**Cronometro contasecondi da tavolo a pila con lancette**  
 Table Clock for basketball



**Art. S04280**  
**Segnapunti**  
**manuale**  
**girevole**  
**a 6 cifre**  
 6 figure  
 Scoreboard



**Art. B01084**  
**Segnapunti per Basket da tavolo**  
 Table scoreboard

pg.38



**Art. S04274**  
**Serie Palette 24"**  
 Set of 24 sec indicators



**Art. S04272**  
**Serie palette per giudici**  
 Set of referee's foul indicators



**Art. S04282**  
**Segnapunti manuale a parete a 6 cifre, struttura in acciaio verniciato**  
 Wall steel 6 digit scoreboard

**Art. 089-B**  
**Lavagna Basket**  
**cancellabile cm. 40x23**  
 Basket Tactical Board  
 erasable 40x23 cm.

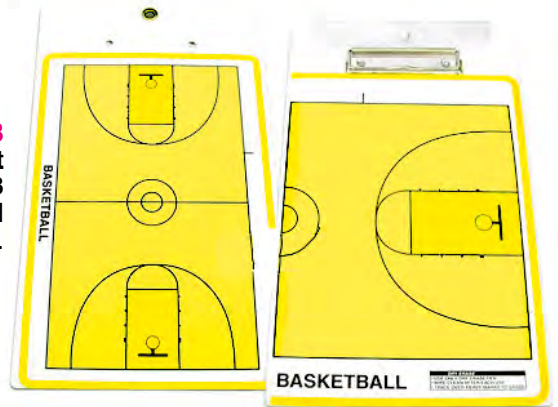

**Art. 087-B**  
**Lavagna Basket**  
**magnetica**  
**cancellabile**  
**cm. 60x85**  
 Basket Tactical  
 Board erasable  
 and magnetic  
 60x85 cm.



**Art. LSRK**  
**Lavagna Basket magnetica cm. 40x23**  
**con block-notes**  
 Basket Tactical Board  
 magnetic 40x23 cm. with block-notes



**Art. B3002** Pallone Basket e Minibasket gomma nylon misure 3-5-7  
Nylon rubber Basket and Minibasket ball



**Art. MSBK4** Pallone avviamento al Minibasket Mondo gomma nylon misura 4  
Minibasket introduction ball



**Art. SB4Y** Pallone avviamento al Minibasket Molten gomma nylon misura 4  
Minibasket introduction ball

 pg.38



**Art. SBPRO5** Pallone Minibasket Mondo SB-PRO n. 5 gomma multistrato  
Multilayer rubber Minibasket Mondo SB-PRO 5 ball



**Art. BGR5** Pallone Minibasket Molten BGR5 gomma nylon  
Nylon rubber Minibasket Molten BGR5 ball



**Art. BGR7/BGR6** Pallone Basket Molten BGR7/BGR6 gomma nylon  
Nylon rubber Basket Molten BGR7/BGR6 ball



**Art. BGM7/BGM6** Pallone Basket Molten BGM7/BGM6 pelle sintetica FIBA Approved  
Leather Basket Molten BGM7/BGM6 ball

**Art. BGF7/BGF6** Pallone Basket Molten BGF7/BGF6 pelle sintetica ufficiale FIP Serie B e C  
Leather Basket Molten BGF7/BGF6 ball



**Art. BGG7/BGG6** Pallone Basket Molten BGG7/BGG6 pelle sintetica ufficiale FIP Serie A1 e A2  
Leather Basket Molten BGG7/BGG6 ball



**Art. TRBB** Pallone reaction ball Trial rimbalzo e traiettorie imprevedibili per Basket  
Trial Reaction Ball unpredictable rebounds



**Art. BYCB** Pallone Basket bicolore gomma Trial Ø cm.24 - gr. 620  
Trial bicoloured rubber Basket ball



**Art. ULTS67** Pallone Basket gomma Trial allenamento potenziato Ø cm. 24 gr. 930 (+50%)  
Rubber Trial Heavier Basket ball



**Art. ULTD67** Pallone Basket gomma Trial allenamento potenziato Ø cm. 24 gr. 1240 (+100%)  
Rubber Trial Heavier Basket ball

## PALLAVOLO - Volleyball



Art. 6746T

**Art. 6746T**  
**Impianto pallavolo**  
**monotubolare**  
**in acciaio zincato**  
**Ø 76 mm.**  
**completo di bossole**  
**da interrare cm. 40**  
**e tendirete,**  
**altezza della**  
**rete regolabile**  
 Volleyball posts in  
 galvanised steel with  
 underground bases  
 adjustable height net

**Disponibile anche**  
**Also available**

**Art. V5003**  
**Impianto pallavolo**  
**monotubolare**  
**in acciaio zincato Ø 70 mm.**  
**completo di bossole**  
**da interrare e tendirete**  
**con sistema periscopico**  
**per la regolazione**  
**dell'altezza dei pali**  
**e della rete**  
 Volleyball posts in  
 galvanised steel with  
 underground bases  
 periscopic posts  
 adjustable height net

pg.40



Art. V5009

**Art. V5009**  
**Impianto**  
**pallavolo**  
**monotubolare**  
**in alluminio T6**  
**antiflessione**  
**mm. 120x100**  
**con arganello**  
**tendirete**  
**autofrenante**  
**e senza**  
**cremagliera**  
**con manovella**  
**asportabile - bossole**  
**e tappi in alluminio**  
 Aluminium  
 monotubular  
 volleyball posts



**Art. MB2083 Coppia**  
**Protezioni in gommapiuma**  
**rivestita per**  
**impianto monotubolare**  
 Pair of soft protections  
 for volleyball posts



**Art. ARGC**  
**Arganello a cremagliera**  
**con maniglia per impianto**  
**pallavolo monotubolare**  
 Spare rack winch for  
 monotubular volleyball  
 posts

**IMPIANTO**  
**= coppia pali**  
**(rete esclusa)**

**Art. 6747/P**  
**Impianto pallavolo**  
**monotubolare a**  
**norme FIPAV**  
**in alluminio**  
**sezione**  
**mm. 120x100**  
**regolazione**  
**dell'altezza**  
**dei pali e della rete**  
**con sistema**  
**periscopico**  
**con arganello**  
**tendirete**  
**e bossole incluse**  
 Aluminium  
 monotubular  
 volleyball posts  
 periscopic system  
 FIPAV approved

**La regolazione**  
**periscopica permette di**  
**variare l'altezza dei pali**  
**oltre a quella della rete**  
**(che può essere regolabile**  
**da cm. 200 a cm. 250)**



Art. 6747/P



**Art. 1009**  
**Impianto pallavolo a traliccio in alluminio**  
 ø mm. 120x100  
**dotato di ruote e tendirete**  
 Volleyball posts in aluminium transportable with wheels, pipe section 120x100 mm.



**Art. MB2236**  
**Coppia protezioni in gommapiuma rivestita per impianto a traliccio**  
 Pair of soft protections for volleyball posts



**Art. 6740**  
**Impianto pallavolo a traliccio ø 70 mm. in acciaio verniciato completo di tendirete**  
 Volleyball posts in painted steel pipe section 70 mm.

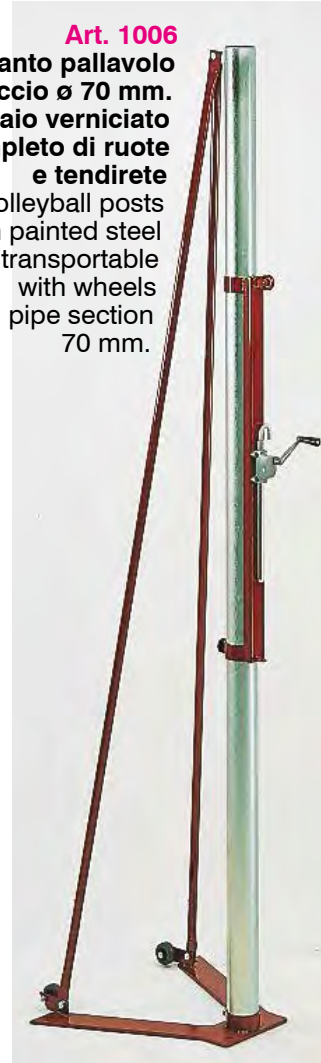

**Art. 1006**  
**Impianto pallavolo a traliccio ø 70 mm. in acciaio verniciato completo di ruote e tendirete**  
 Volleyball posts in painted steel transportable with wheels pipe section 70 mm.



**Art. S04706**  
**Coppia protezioni per impianto Pallavolo a parete**  
 Pair of soft protections for volleyball posts for wall fixing

**Art. S04704**  
**Impianto Pallavolo a parete**  
 Volleyball posts for wall fixing

pg.40

**IMPIANTO = coppia pali (rete esclusa)**

**Art. V5029**  
**Impianto pallavolo a tiranti ridotti in lega di alluminio profilo sezione mm. 120x100 con ruote per il trasporto piastra antitorsione alla base, arganello tendirete autofrenante senza cremagliera antinfortunistico**  
 Volleyball posts in aluminium transportable with wheels, pipe section 120x100 mm.





**Art. P030**  
**Rete pallavolo m. 9,50**  
Net for volleyball

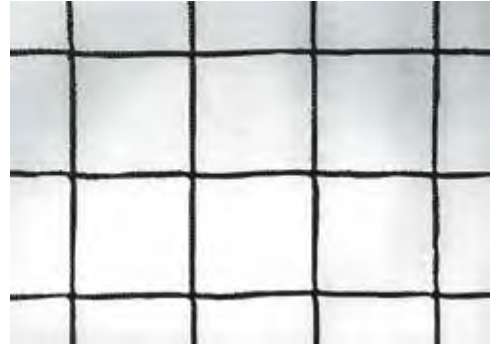

**Art. P100**  
**Rete pallavolo super pesante m. 9,50**  
Heavy net for volleyball



**Art. P110**  
**Rete pallavolo extra pesante m. 9,50 a doppia fascia**  
Heavy net for volleyball double band

pg.41



**Art. P200**  
**Rete pallavolo da gara con antenne e tasche a norma FIPAV**  
Official net for volleyball



**Art. P14**  
**Coppia antenne in vetroresina divise**  
Fiberglass sticks in 2 pieces

**Art. P15**  
**Coppia bande verticali cm. 5**  
Fixing bands for sticks

**Art. P16**  
**Coppia antenne in vetroresina intere**  
One piece fiberglass sticks



**Art. S04814**  
**Segnapunti manuale girevole a 4 cifre**  
4 figure scoreboard



**Art. PP054**  
**Segnapunti manuale da tavolo per Pallavolo bifacciale (numeri da 0 a 50 non divisi)**  
Volleyball table scoreboard



**Art. PPP30**  
**Segnapunti scolastico per Pallavolo numeri da 0 a 30 rinforzati**  
Volleyball school scoreboard

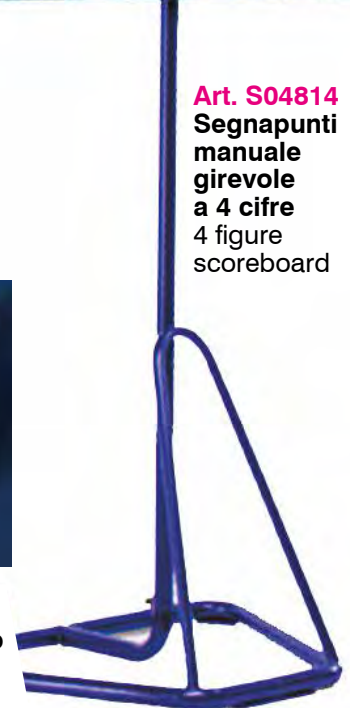





**New!**

**Art. 6768R**  
**Seggiolone arbitro pallavolo in piedi, in acciaio verniciato, mobile su ruote**  
 Referee's stand made of painted steel, on wheels

pg.41



**Art. S04804**  
**Seggiolone arbitro pallavolo ad altezza fissa con scocca di seduta, in acciaio verniciato, mobile su ruote**  
 Referee's stand fixed height with plastic seat, made of painted steel, on wheels



**Art. 1020**  
**Seggiolone arbitro pallavolo approvato FIPAV regolabile in altezza con scaletta di accesso e ruote per trasporto**  
 Referee's chair



**Art. VSRK**  
**Lavagna per Pallavolo magnetica cancellabile con block-notes cm. 36x23**  
 Magnetic erasable Volleyball Tactical Board 36x23 cm.



**Art. 089-V**  
**Lavagna per Pallavolo cancellabile cm. 35x25**  
 Volleyball Tactical Board erasable cm. 35x25



**Art. S04816**  
**Serie 18 Palette per sostituzione giocatori con contenitore**  
 Set of 18 substitution indicators



**Art. V5081**  
**Simulatore di muro su ruote in acciaio, zavorrato, con pannello a superficie irregolare**  
 Portable wall in painted steel with irregular surface board



**Art. V5082**  
**Simulatore di muro portatile per squadre femminili e giovanili**  
 Portable wall for women and kids

pg.41



**Art. P11032**  
**Misuratore di elevazione da fissare a muro (misura l'elevazione da 1 a 3,40 metri)**  
 Wall jump meter in plastic (up to 340 cm.)



**Art. V5051** **Jump Tester in acciaio zincato telescopico regolabile da cm. 230 a cm. 380 (basamento non incluso)**  
 Jump Tester in painted steel telescopic adjustable height from 230 to 380 cm. (base not included)



**Art. V5070**  
**Ball Catcher cm. 70x70 altezza regolabile da cm. 190 a cm. 320 con anello superiore inclinabile, basamento e retone inclusi**  
 Ball catcher, adjustable height and inclination (base and net included)



**Art. V5060** **Spike con ganasce (basamento non incluso)**  
 (base not included)

**Art. V5050**  
**Basamento zavorrato multiuso per Ball Catcher, Spike, Jump Tester**  
 Multi-purpose weighted base





**Art. BV20**

**Pallone Volley Trial in gomma supersoft**  
Supersoft Trial Volley ball



pg.41

pg.42



**Art. V20**

**Pallone Volley Trial in gomma monostrato**  
Single stratum Trial Volley ball



**Art. ULT20-3**

**Pallone Volley Trial in gomma triplo strato**  
Triple stratum Trial Volley ball

**Art. MVBS**

**Pallone Volley School Mondo peso ridotto Under 13**  
Under 13 Mondo Volley School ball

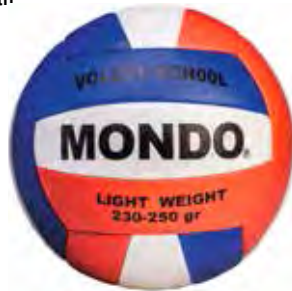

**Art. E6835**

**Pallone Volley Soft Touch in PU saldato, regolamentare**  
Official size and weight Volley ball



**Art. 18335**

**Pallone Volley School Molten Under 13 peso ridotto V5M2501-L**  
Under 13 Molten Volley School ball



**Art. 29096**

**Pallone Volley Molten allenamento Ultra Touch V5M1500**  
Molten Volley training ball



**Art. 6036**

**Pallone Volley Molten V5M4000**



**Art. 6331**

**Pallone Volley gara Molten V5M5000 "FLISTATEC" FIVB Approved**



**Art. BYCV**

**Pallone Volley Trial gomma bicolore**  
Trial bicoloured rubber Volley ball



**Art. TRBV**

**Pallone Reaction Ball Trial doppio strato per Volley rimbalzo e traiettorie imprevedibili**  
Trial Volley ball for unpredictable rebounds



**Art. MTVSC**

**Pallone Volley Molten Serve Cut**



**Art. USE20**

**Pallone Volley Trial gr. 405 (+50%) ø cm. 21 per allenamento potenziato**  
Rubber Trial heavier Volley ball



**Art. ULTD20**

**Pallone Volley Trial gr. 540 (+100%) ø cm. 21 per allenamento potenziato**  
Rubber Trial heavier Volley ball

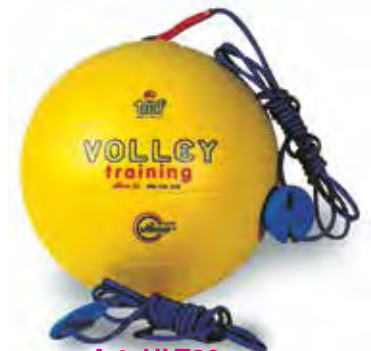

**Art. ULT22**

**Pallone Volley Trial training con 2 elastici**  
Trial training Volley ball with 2 elastic ropes

## MINIVOLLEY

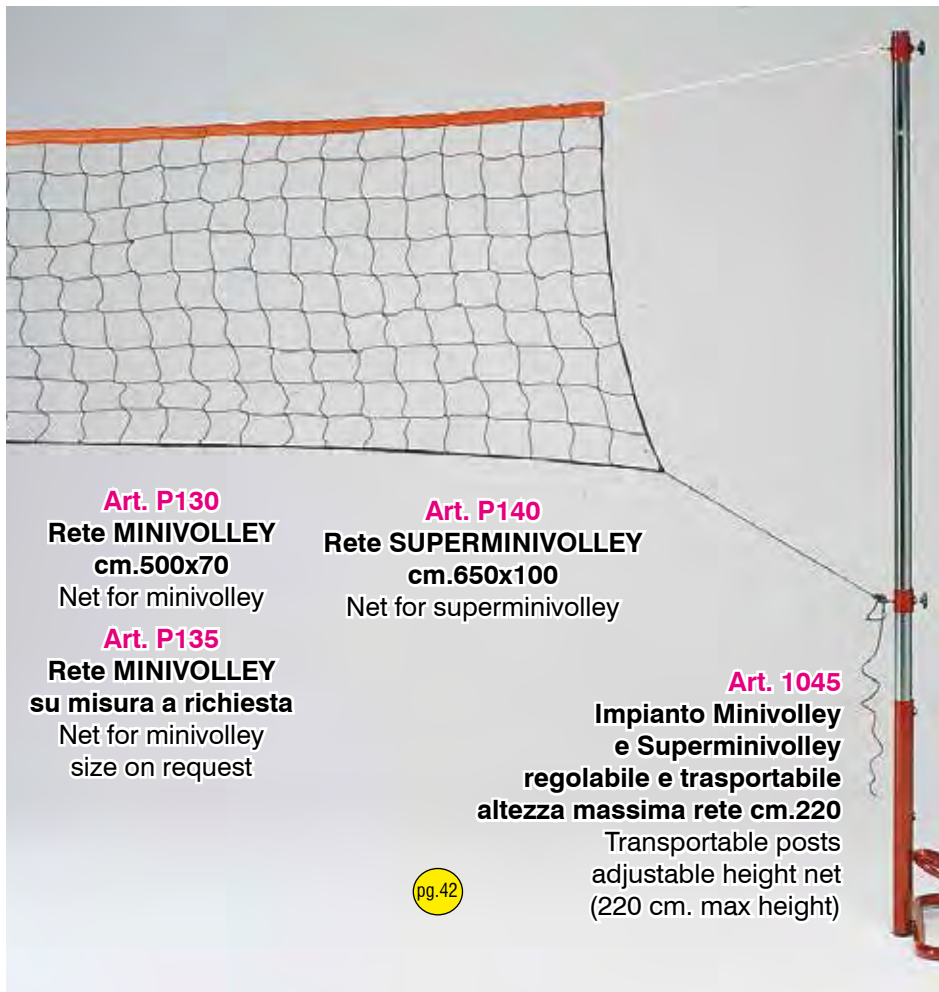

**Art. P130**  
**Rete MINIVOLLEY**  
 cm.500x70  
 Net for minivolley

**Art. P135**  
**Rete MINIVOLLEY**  
 su misura a richiesta  
 Net for minivolley  
 size on request

**Art. P140**  
**Rete SUPERMINIVOLLEY**  
 cm.650x100  
 Net for superminivolley

**Art. 1045**  
**Impianto Minivolley**  
**e Superminivolley**  
**regolabile e trasportabile**  
**altezza massima rete cm.220**  
 Transportable posts  
 adjustable height net  
 (220 cm. max height)

pg.42



**Art. BV15**  
**Pallone PRIMO VOLLEY**  
**Trial in gomma supersoft**  
 Trial supersoft Volley ball



**Art. ULT15-3**  
**Pallone PRIMO VOLLEY**  
**Trial in gomma triplo strato**  
 Trial triple stratum Volley ball



**Art. 191S**  
**Pallone**  
**MINIVOLLEY**  
**in gomma Mondo**  
 Mondo rubber  
 Minivolley ball



**Art. V33**  
**Pallone**  
**MINIVOLLEY**  
**in gomma Trial**  
 Trial rubber  
 Minivolley ball



**Art. V27**  
**Pallone**  
**SUPERMINIVOLLEY**  
**in gomma Trial**  
 Trial rubber  
 Superminivolley ball



**Art. MV140**  
**Pallone MINIVOLLEY**  
**"First Touch" Molten**  
 nylon gr.140  
 (ad esaurimento)



**Art. MV210**  
**Pallone MINIVOLLEY**  
**"First Touch" Molten**  
 nylon gr.210  
 (ad esaurimento)



**Art. 6332**  
**Pallone**  
**MINIVOLLEY**  
**in gomma Molten**



**Art. ULT26-3 / ULT27-3**  
**Pallone MINIVOLLEY/**  
**SUPERMINIVOLLEY**  
**in gomma**  
**triplo strato Trial**

## IMPIANTI MULTIFUNZIONE Multi-purpose systems



**New!**



**Art. S05208**  
Coppia tabelloni in plastica con canestro su supporto in acciaio per Art. S05206  
Pair of Basket Boards with baskets and steel back frames for Art. S05206



**Art. S05209**  
Set protezioni per impianto multifunzione Art. S05206  
Soft Protection set for transportable system Art. S05206

pg.45

**Art. S05202**  
Impianto multifunzione volley, minivolley, badminton, tennis trasportabile zavorrato strutture verticali in acciaio zincato e verniciato, con ruote  
Volley, Minivolley, Badminton and Tennis transportable system



**Art. S05204**  
Impianto multifunzione come Art. S05202 ma valido anche per basket (con tabelloni in plastica)  
Same of Art. S05202 but also for basket (with plastic boards)

**Art. S05206**  
Impianto multifunzione professionale per volley, minivolley, tennis e salto in alto - basi zavorrate in acciaio zincato su ruote gommate, ritti centimetrati in alluminio verniciato con cursore scorrevole  
Volley, Minivolley, Tennis and High Jump transportable system - galvanized weighted bases with wheels, posts in painted aluminium with slider



**Art. S05210**  
Rete per impianti multifunzione Art. S05202/S05204/S05206  
dimensioni m. 9x1  
Net for multi-purpose systems size m. 9x1

**New!**

**Art. 6780M**  
Impianto volley e minivolley trasportabile zavorrato  
Weighted Volley and Minivolley transportable system

pg.40



**Art. PA020**  
Impianto multifunzione trasportabile completo di protezioni

Volley, Minivolley, Badminton and Beach Tennis transportable system

Altezza rete (non inclusa) regolabile da cm. 91 a cm. 245  
Basi in ABS con ruote, riempibili con sabbia

## BEACH VOLLEY

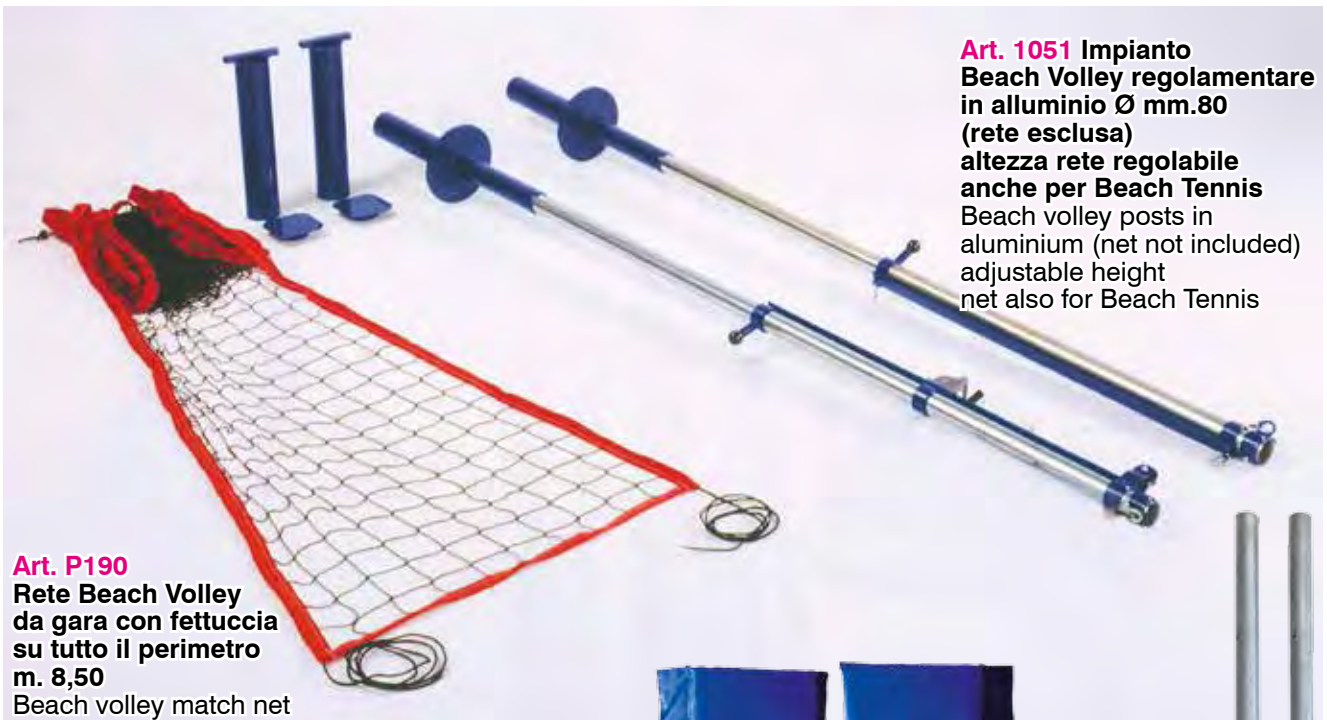

**Art. 1051** Impianto Beach Volley regolamentare in alluminio Ø mm.80 (rete esclusa) altezza rete regolabile anche per Beach Tennis  
Beach volley posts in aluminium (net not included) adjustable height net also for Beach Tennis

**Art. P190**  
Rete Beach Volley da gara con fettuccia su tutto il perimetro m. 8,50  
Beach volley match net

pg.42

pg.43



**Art. P170**  
Rete Beach Volley m. 8,50 con fettuccia sul lato superiore  
Beach volley net



Lato A Lato B

**Art. BVMBP**  
Coppia protezioni per impianto Beach Volley regolamentare altezza cm. 200 - diametro cm. 8  
Pair of Beach Volley posts soft protections



**Art. F501** Impianto Mini Beach Volley portatile con pali telescopici in ferro verniciato completo di rete mt. 6,5x1 e sacca  
Mini Beach Volley complete set



**Art. F501**



**Art. V5510**  
Impianto Beach Volley in acciaio zincato (rete esclusa) altezza rete regolabile anche per Beach Tennis  
Beach Volley posts in galvanized steel (net not included) adjustable height net also for Beach Tennis



**Art. V5543**

**Seggiolone per arbitro Beach Volley in acciaio ovale verniciato a polveri sez. mm.60 antinfortunistico e richiudibile in soli 45 cm. Beach Volley referee's Stand**

**Art. V5428**

**Set imbottiture per seggiolone Art. V5543  
Set of Soft Protections for Art. V5543**



**Art. P17**

**Kit Delimitazione campo Beach Volley (2 nastri m.16 + 2 nastri m. 8 + 8 picchetti + 8 elastici) nastri da mm. 50 occhiellati alle estremità  
Set for Beach Volley Bounds**



**Art. P19 Kit Delimitazione regolabile per campo Beach Volley e Beach Tennis (2 nastri m.16 + 2 nastri m.8 oppure 2 nastri m.18 + 2 nastri m.9) colore blu  
Set for Beach Volley and Beach Tennis bounds adjustable blue color**



**Art. M820  
Pallone Beach Volley in pelle sintetica**

pg.43



**Art. 6340  
Pallone Beach Volley da gara Molten BV5000  
Pallone ufficiale FIVB**

**New!**



**Art. 29097  
Pallone Beach Volley Molten "Sweet Touch"**

## PROTEZIONI - Protections



**Art. E6644**

**Paio ginocchiere Volley trapuntate misura S, M, L  
colori royal, nero, rosso, navy**  
Pair of knee protections size S, M, L



**Art. E6642**

**Paio ginocchiere Volley gara misura JR e SR  
colori royal, rosso e nero**  
Pair of knee protections for match size JR and SR

pg. 42



**\*Art. 9293**  
**Paradenti singolo  
taglia adulto**  
Adult Mouthguard

**\*Art. 9293.B**  
**Paradenti singolo  
taglia bambino**  
Junior Mouthguard

**\*Disponibili  
anche senza  
reggi-paradenti**



**Art. 43602A**  
**Paradenti doppio  
taglia S-L**  
Double Mouthguard Size S-L



**Art. E6641**

**Paio ginocchiere Volley  
regolabili con velcro, misura SR colori blu e nero**  
Pair of pro knee protections size SR adjustable with velcro - colors black and blue



**Art. PDFOX**  
**Paradenti Fox singolo  
taglia adulto - vari colori**  
Adult Fox mouthguard - various colors



**Art. E6633** **Paio gomitiere Volley, misura JR e SR  
colori royal, rosso e nero**  
Pair of elbow protections size JR and SR



**Art. ESPN**  
**Maschera di  
protezione per  
naso, zigomi  
e arcata  
sopracciliare**  
Face Protection  
Mask



**Art. 73001**  
**Sospensorio  
con conchiglia,  
misura S, M, L**  
Shell Protection  
size S, M, L





Art. E6649

Art. E6650

Art. E6670

**Art. E6649**

**Paio ginocchiere elasticizzate misura S-M-L-XL**  
Pair of elastic Knee Protections size S-M-L-XL

**Art. E6650**

**Paio cosciere elasticizzate misura S-M-L-XL**  
Pair of elastic Thigh Protections, size S-M-L-XL

**Art. E6670**

**Paio cavigliere elasticizzate misura S-M-L-XL**  
**colore nero o bianco**  
Pair of elastic Ankle Protections size S-M-L-XL  
colors: black, white



**Art. IS799**  
**Ginocchiera**  
**con supporti rigidi**  
**taglia S/M - L/XL**  
Knee protection  
with metal support



**Art. E795**  
**Ginocchiera in neoprene**  
**taglia S-M-L-XL**  
Neoprene Knee Protection



**Art. E798**  
**Supporto Coscia**  
**in neoprene**  
**taglia S-M-L-XL**  
Neoprene Thigh  
Protection



**Art. E786**  
**Cavigliera in neoprene**  
**taglia S-M-L-XL**  
Neoprene Ankle Protection

pg.42



**Art. 2651A**  
**Short in neoprene**  
**vita alta colore nero**  
**taglia S-M-L-XL**  
Neoprene Shorts



**Art. 90252A**  
**Fascia sottorotulea in neoprene**  
Neoprene underknee band



**Art. E796**  
**Supporto gomito in neoprene**  
**taglia unica regolabile**  
Neoprene Elbow Protection  
one size fits all

**Art. AHF-079**  
**Pancierina in neoprene**  
**taglia unica 120x25x0,4 cm**  
Neoprene Stomach band  
25 cm. height



## PALLAMANO - Handball



**Art. 1096**  
Coppia porte pallamano  
in alluminio, reti escluse  
Pair aluminium handball Goals

Le reti per porte pallamano  
corrispondono alle reti  
per porte calcetto m. 3x2  
Same nets as futsal goals m. 3x2

pg.42



**Art. SH1**  
Pallone Pallamano Trial Micro/Midi  
Handball per l'apprendimento  
dei fondamentali  
Trial Rubber Micro/Midi Handball  
helps in learning the basics

**New!**



**Art. BA25/BA0/BA29/BA30**  
Pallone Pallamano  
Trial in gomma supersoft  
junior / femm.  
Handball supersoft  
junior / size 2 in rubber



**Art. M525**  
Pallone Pallamano  
Mondo in gomma  
mis. 3  
(ad esaurimento)  
Handball size 3  
Mondo in rubber  
(until available)



**Art. IS874**  
Pallone Pallamano  
pelle sintetica  
mis. 2  
(ad esaurimento)  
Handball size 2  
in synthetic leather  
(until available)



**Art. M13651/M13650**  
Pallone Pallamano  
Mondo Golden  
pelle sintetica  
mis. 2 o mis. 3  
Handball size 2 and 3  
in synthetic leather



**Art. V29 / V30 / V49 / ULT49-3 / ULT30-3**  
**ULT303.15 / ULT29-3 / ULT24-3**  
Pallone Pallamano in gomma  
Trial (mono e triplo strato) mis. 0-1-1,5-2-3  
Trial Handball in rubber (single and triple stratum)  
size 0-1-1,5-2-3



pg.43 pg.44



**Art. ULT36-3 / ULT37-3**  
Pallone Beach Handball in gomma Trial triplo strato  
femminile mis. 2 e maschile mis. 3  
Trial Beach Handball in rubber size 2 and size 3



**Art. ULTS29 / ULTD29**  
**ULTS30 / ULTD30**  
**ULTS49 / ULTD49**  
Pallone gomma Trial  
potenziato  
Ø 15/17/18,5 cm.  
gr. 375/500/550/630/  
700/750  
(+50% / +100%)  
Rubber Trial Heavier Handball



**Art. TRBH**  
Pallone Reaction Ball Trial  
doppio strato  
rimbalzo e traiettorie imprevedibili  
Trial Reaction Ball unpredictable  
rebounds - for Handball



**Art. BYCH**  
Pallone Pallamano  
bicolore gomma Trial  
Ø cm.18,5 gr.420  
Trial bicoloured  
Handball

## TABELLONI ELETTRONICI BASKET, PALLAVOLO, MULTISPORT Electronic scoreboards for basketball, volleyball, multisport



### Art. F160

pg.38

Tabellone portatile multisport da tavolo con tastiera di comando per BASKET, VOLLEY, CALCETTO, PALLANUOTO, PALLAMANO, KICK BOXING, PING PONG etc. punteggi da 0 a 199 per lato set/bonus/falli da 0 a 9 per lato cronometro massimo 99 minuti e 59 secondi periodi da 0 a 9 - altezza cifre cm.9 dim. cm. 55x35x9,5  
Multisport Table Scoreboard (for BASKET, VOLLEY, FUTSAL, WATER POLO, HANDBALL, KICK BOXING, TABLE TENNIS)

**New!**



### Art. F345

Tabellone elettronico PLAY30-V con console solo tasti e m. 60 di cavo - dim. cm. 85x38x11 h. cifre cm. 17,4 - indicato per VOLLEY, CALCETTO, PING PONG, BADMINTON, SQUASH punteggi 0-199 per lato - set/bonus da 0 a 9 per lato - possesso/priorità/turno lato dx o sx Electronic Board with console, dim. cm. 85x38x11 cm. 17,4 cm. high figures

### Art. F345D

Tabellone elettronico PLAY30-V con console dotata di display - Art. F345 with display console

### Art. F345T

Tabellone elettronico PLAY30-V con console solo tasti e telecomando a infrarossi

Art. F345 with remote control



### Art. F351D

pg.39

Tabellone MULTISPORT PLAY30-C con console a display luminoso per BASKET, VOLLEY, CALCETTO, PALLAMANO etc. punteggi da 0 a 199 per lato - set/bonus/falli da 0 a 9 per lato - cronometro 99 minuti e 59 secondi altezza cifre punteggio cm.17,4 - altezza cifre cronometro cm.15 - segnalazione acustica di fine tempo dim. cm.75x59x10 - Peso Kg.12,4 cavo console 60 metri



### Art. F300-14

Cronometro da esterno (minuti + secondi)  
dim. cm.166,5x59x15 - h. cifre cm. 45 con console  
Timer for outdoor with console



### Art. F331T

Cronometro da interno (minuti + secondi)  
dim. cm.85x38x11 con telecomando a infrarossi  
Timer for indoor with remote control



**Art. F3045015**

Tabellone MULTISPORT dimensioni cm.91x60x9,5  
 peso Kg.10 - utilizzabile per BASKET, VOLLEY, CALCETTO  
 altezza cifre cm.15 - visualizzazione di punteggi, cronometro,  
 timeout, falli squadra, periodo, possesso palla.  
 Console Art. F307-01 o Art. F308-01 non inclusa  
 Electronic Board, dim. 91x60x9,5 cm.  
 15 cm. high figures for various sport.  
 Console Art. F307-01 or Art. F308-01 not included



**Art. F307-01**

Console 300 per Art. F3045015  
 Display LCD - utilizzabile per  
 collegamento via cavo  
 dim. cm.28,5x10,5x8  
 Console for Art. F3045015 with cable system



**Art. F308-01**

Console 700 per Art. F242,  
 Art. F3045025 e Art. F3045015  
 Display touchscreen - utilizzabile per  
 collegamento sia via cavo che via radio  
 dim. cm.24,5x17x8,5  
 Console for Art. F242, Art. F3045025  
 and Art. F3045015 with cable or radio system

pg.39



**Art. F3045025**

Tabellone segnapunti MULTISPORT  
 Omologato FIBA livello 3  
 (BASKET, VOLLEY, CALCETTO, PUGILATO, TENNIS,  
 PING PONG, BADMINTON etc.)  
 altezza cifre cm.25 distanza di leggibilità m.110  
 peso Kg.22 - dimensioni cm.140x83x9  
 da utilizzare con console Art. F308-01 (non inclusa)  
 Electronic Board, dim. 140x83x9 cm.  
 25 cm. high figures for various sport.  
 Console Art. F308-01 not included



**Art. F270**

Kit indicatori elettronici 24 secondi  
 (h. cifre cm.20) dim. cm.29,2x30,4x4,4 cadauno  
 completo di centralina munita di tastiera  
 visualizzazione del tempo di tiro e del timeout  
 segnalatori acustici di fine tempo, un cavo m.20  
 e un cavo m.40 in dotazione  
 Kit 24 second indicators with console



pg.39

**Art. F308-01**

Console 700 per Art. F242, Art. F3045025 e Art. F3045015  
Display touchscreen - utilizzabile per collegamento sia via cavo che via radio  
dim. cm.24,5x17x8,5  
Console for Art. F242, Art. F3045025 and Art. F3045015 with cable or radio system

**Art. F242**

**Tabellone MULTISPORT FS-130**  
dimensioni cm.200x180x9 - peso Kg.60  
costruito secondo le disposizioni FIBA  
utilizzabile per BASKET, VOLLEY, CALCETTO,  
PALLAMANO, HOCKEY, TENNIS etc.  
altezza cifre cm.30 tempo di gioco 99:59  
punteggi di squadra (da 0 a 199) - periodo (0 - 9)  
falli di squadra/set vinti (da 0 a 9) - bonus  
(1 punto luminoso per squadra)  
timeout (3 punti luminosi per squadra)  
possesso/servizio/turno: frecce indicatrici  
indicazione ultimo fallo avvenuto  
(numero di maglia del giocatore e numero del fallo)  
Console Art. F308-01 non inclusa  
Electronic Board, dim. 200x180x9 cm.  
30 cm. high figures for various sport  
Console Art. F308-01 not included

**Art. F253-01**

Kit cornice luminosa e centralina di comando per tabellone basket  
Ledstrip cm.515  
Kit light frame and control unit for basketball backboard  
Ledstrip 515 cm.

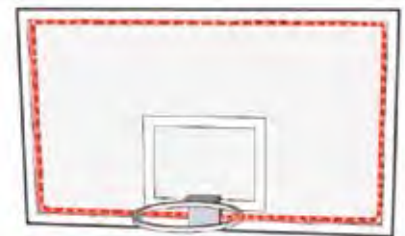

pg.39

pg.40



**Art. F265-20**

Ricevitore radio per collegamento del tabellone indicatore 24 secondi  
Art. F258-1 alla console Art. F308-01  
N.B. Per un impianto Basket completo occorrono  
n. 2 Art. F253-01 + n. 2 Art. F258-1 + n. 2 Art. F265-20  
Radio receiver connecting Art. F258-1 to Art. F308-01



**Art. F258-1**

Tabellone elettronico indicatore dei 24 secondi e tempo di gioco FS-24s-1  
dim. cm.70,5x60x11,5 h. cifre cm.14 e cm.30 - da collegare con  
Art. F253-01, completo di cavo m.50 per collegamento alla console  
Art. F308-01 - protetto contro gli urti della palla - N.B. Per un impianto Basket completo occorrono  
n. 2 Art. F253-01 + n. 2 Art. F258-1  
24 second indicator board



pg.40

**Art. F300-26**

Tabellone elettronico da esterno ideale per CALCIO, CALCIO RIDOTTO E CALCETTO  
dim. cm.166,5x118x15 - altezza cifre 45cm.  
Punteggio squadre da 0 a 9 - Cronometro 99:59  
orologio - resistente agli urti della palla,  
da utilizzare con console Art. F308-01 (non inclusa)  
Electronic scoreboard for outdoor - ideal for Soccer, Futsal - resistant to ball hits  
(console Art. F308-01 not included)

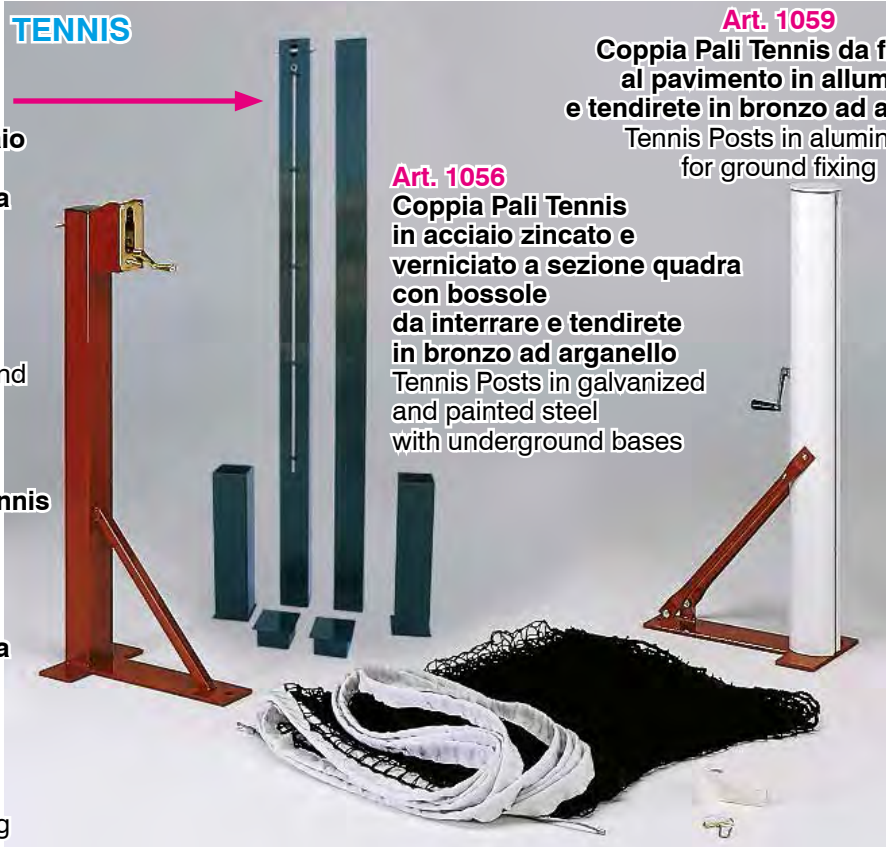

**TENNIS**

**Art. 8820G**  
Coppia Pali Tennis in acciaio verniciato a sezione quadra con bossole da interrare e tendirete  
Tennis Posts in painted steel with underground bases

**Art. 1058**  
Coppia Pali Tennis da fissare al pavimento in acciaio verniciato a sezione quadra e tendirete in bronzo ad arganello  
Tennis Posts in painted steel for ground fixing

**Art. 1059**  
Coppia Pali Tennis da fissare al pavimento in alluminio e tendirete in bronzo ad arganello  
Tennis Posts in aluminium for ground fixing

**Art. 1056**  
Coppia Pali Tennis in acciaio zincato e verniciato a sezione quadra con bossole da interrare e tendirete in bronzo ad arganello  
Tennis Posts in galvanized and painted steel with underground bases

pg.44



**Art. 8819G**  
Coppia Pali Tennis in alluminio con bossole da interrare e tendirete  
Tennis Posts in aluminium with underground bases

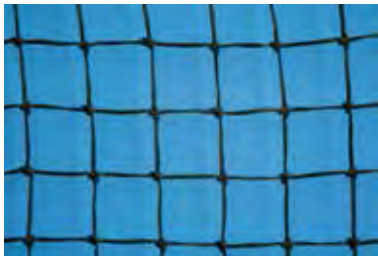

**Art. T030**  
Rete Tennis annodata m.12,80 x 1  
Tennis knotted net



**Art. T040**  
Rete Tennis da gara annodata modello Wimbledon m.12,80 x 1  
Tennis knotted match net



**Art. RT1**  
Centro rete  
Net central holder



**Art. 1066**  
Seggiolone per arbitro verniciato  
Painted referee's Chair



**Art. TE10031**  
Rete per impianto  
**Art. TE10030**  
Net for Art. TE10030  
**Art. TE10030**  
Impianto Junior Tennis cm. 500x100 in acciaio trasportabile (rete esclusa)  
Transportable junior Tennis posts in steel (net not included)



**Art. S04862**  
Impianto Tennis in acciaio zincato trasportabile (rete e zavorra escluse)  
Transportable Tennis posts in galvanized steel (net and weights not included)



**Art. S04868**  
Coppia paletti per singolo in acciaio verniciato  
Pair of steel poles for single



**Art. RTAD / RTB912 / RTB58**  
**Racchetta Tennis Dunlop in lega**  
 23" (5/8 anni) - 25" (9/12 anni) - 27" (adulti)  
 Tennis rackets



**Art. 44.045**  
**Over Grip**



**Art. E6620**  
**Paio Polsini**  
**terg sudore**  
 altezza cm. 7  
 Pair of  
 Wrist bands



**Art. E6610**  
**Fascia terg sudore**  
 altezza cm. 5  
 Headband

pg.45



**Art. AGDP**  
**Tubo 3 palle Tennis**  
**depressurizzate Dunlop**  
 Set 3 depressurized  
 Tennis balls



**Art. T4D**  
**Tubo 4 Palle Tennis**  
**Dunlop**  
**Omologate ITF**  
 Set 4 Tennis Balls

**Art. 07861**  
**Set 3 palline**  
**gommapiuma**  
 Set 3 foam rubber  
 Tennis balls



**Art. 48018**  
**Racchetta Beach Tennis in resina**  
**(il colore ed il disegno possono variare)**  
 Beach Tennis racket

pg.44

## BEACH TENNIS



**Art. PT41**  
**Pallina Beach Tennis**  
 Beach Tennis ball



**Art. P210**  
**Rete Beach Tennis**  
**con fettuccia su tutto**  
**il perimetro**  
 Beach Tennis net



**Art. TE18002**  
Cesto contenitore e raccogli-palle con ruote  
Basket for picking up Tennis balls



**Art. TE22005**  
Macchina lancia palline Spinshot plus  
velocità max 120 km/h  
velocità min. 30 km/h  
frequenza lancio da 2 a 10 secondi  
Ball throwing machine

pg.45



**Art. TE51.04**  
Rullo in acciaio con racla  
Levelling roller



**Art. RT3**  
Rotolo m. 150 strisce segnacampo Tennis in PVC mm. 50  
150 m. set  
Tennis lines in PVC



**Art. RT10**  
Stuoia livellatrice per campi in terra battuta m.2x1,5  
Levelling net m.2x1,5

pg.44

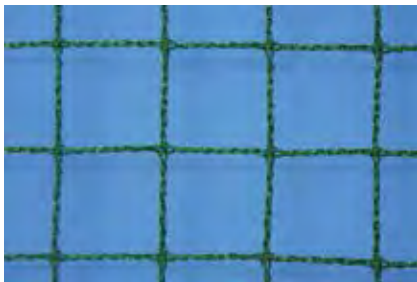

**Art. 0934LR**  
Rete protezione polietilene verde maglia cm. 4,5x4,5 sp. mm. 2  
Protection Net green polyethylene mesh 4,5x4,5 cm. thick 2 mm.



**Art. 40 - 40/S - 41 - 41/S**  
Telo fondo campo tennis densità 90% o 70% mt.18x2 con o senza banda di rinforzo  
Tennis perimeter net density 90% or 70% dim. 18x2 meters



**Art. TE53083**  
Tabellone segnapunti Tennis cm. 100x77 h. cifre cm. 12 completo di agganci per la recinzione  
Tennis scoreboard 100x77 cm.



**Art. F166PST**  
Tabellone elettronico portatile da tavolo per Tennis  
Portable Tennis electronic scoreboard



## TENNIS TAVOLO - Table Tennis

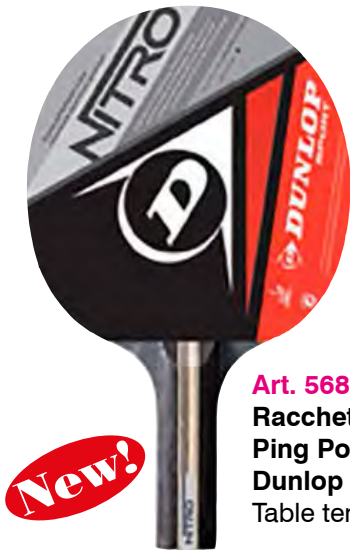

**Art. 568001**  
**Racchetta**  
**Ping Pong**  
**Dunlop**  
Table tennis bat

**New!**



**Art. 48439**  
**Racchetta**  
**Ping Pong**  
**Expert**  
(ad esaurimento)  
Expert table tennis bat  
(until available)



**Art. 83925A**  
**Racchetta**  
**Ping Pong**  
**Dunlop Spin**  
Dunlop Spin  
table tennis bat



**Art. 48441**  
**Confezione 6 Palline**  
Set of 6 table tennis balls

pg.46



**Art. 17883**  
**Confezione 144 Palline**  
**colore bianco o arancio**  
Set of 144 table tennis balls



**Art. 17362**  
**Confezione 3 Palline**  
**Stiga 3 Star ITTF**  
Set of 3 table tennis Stiga balls



**Art. PP50**  
**Rete in polietilene**  
Net



**Art. E5019**  
**Rete Ping Pong**  
**regolabile portatile universale**  
Table tennis net adjustable length



**Art. 48448**  
**Set rete con paletti**  
Net with holder



**Art. PPP30**  
**Segnapunti per Ping Pong numeri da 0 a 30 rinforzati**  
Table tennis scoreboard



**Art. TEC.I**  
**Tennis tavolo Tectonic indoor per interno**  
Indoor Table Tennis Tectonic

**Art. TEC.O**  
**Tennis tavolo Tectonic outdoor per esterno**  
Outdoor Table Tennis Tectonic



**Art. C250.I**  
**Tennis tavolo Cornilleau modello Sport 250 da interno**  
Indoor Table Tennis Cornilleau Sport 250

● pg.45



**Art. C150S.O**  
**Tennis tavolo Cornilleau modello 150S da esterno**  
Outdoor Table Tennis Cornilleau 150S



**Tutti i tavoli sono pieghevoli e su ruote**  
All models are foldable and on wheels





**Art. C400M.O**  
**Tennis tavolo Cornilleau**  
**modello 400M da esterno**  
Outdoor Table Tennis  
Cornilleau 400M

pg.45



**Art. C500.I**  
**Tennis tavolo Cornilleau**  
**modello 500 da interno**  
Indoor Table Tennis  
Cornilleau 500



**Art. C510.O**  
**Tennis tavolo Cornilleau**  
**modello 510 da esterno**  
Outdoor Table Tennis  
Cornilleau 510

## BADMINTON



**Art. P160**  
**Rete**  
**Badminton**  
**cm. 610x70**  
Badminton Net

**V7700**  
**Impianto Badminton**  
**in acciaio verniciato**  
**zavorrato, su ruote, con tendirete**  
**(rete esclusa)**  
Badminton set (net not included)



**Art. 23461**  
**Racchetta Badminton**  
**in acciaio/alluminio**  
Badminton Racket  
in steel/aluminium

pg.47



**Art. PAC12**  
**Racchetta Badminton**  
**in grafite/alluminio**  
Badminton Racket  
in graphite/aluminium



**Art. 22309**  
**Volano**  
**Badminton**  
**interamente**  
**in plastica**  
Plastic  
Shuttlecock

**Art. AS85**  
**Volano**  
**Badminton**  
**capsula in**  
**sughero**  
Cork tip  
Shuttlecock



pg.48



**Art. JIN**  
**Impianto**  
**Mini Badminton**  
**mt.4,40x1,50**  
**telescopico portatile**  
**completo**  
**di rete e borsa**  
Portable mini  
Badminton  
set mt. 4,40x1,50  
with net and bag

## RUGBY



**Art. 8836G1 / 8836G**  
**Coppia Porte Rugby**  
**in alluminio verniciato**  
**m. 11 / m. 10 fuori terra**  
Rugby Goals  
in painted aluminium



**Art. 34721**  
**Pallone rugby**  
**in pelle sintetica**  
Rugby training ball  
in synthetic leather



**Art. V71**  
**Pallone mini-rugby Trial**  
**in gomma monostrato**  
**gr. 350 dim. cm.15/27**  
Trial rubber mini-rugby Ball  
single stratum

pg.47

**Art. ULT71**  
**Pallone mini-rugby Trial**  
**in gomma doppio strato**  
**gr.350 dim. cm.15/27**  
Trial rubber mini-rugby Ball  
double stratum



**Art. F1645X**  
**Pallone football americano**  
pelle sintetica - synthetic leather



**Art. ULT70**  
**Pallone rugby Trial**  
**in gomma doppio strato**  
**gr. 450 dim. cm.19/28**  
Trial rubber rugby Ball  
double stratum



**Art. 6M18**  
**Tacchetti rugby mm.18**  
**in alluminio**  
Rugby aluminium studs  
18 mm.



**Art. 993156/993157/993162**  
**Protezione imbottita per**  
**montante porta rugby**  
**h. cm. 200, modello**  
**quadrato oppure tondo**  
Soft Protection for rugby  
goal post, square and round  
shape, height 200 cm.

**Art. 993164**  
**Copri bandierina**  
**cm.10x10x100 h.**  
Protection for rugby flag  
pole, 10x10x100 cm.



**Art. 993032**  
**Scudo protezione rugby**  
**cm.75x35x15**  
Rugby Shield



**Art. 993151/993153JR**  
**Sacco placcaggio rugby h.**  
**cm.140 o cm.120 diam. cm. 45**  
**o cm. 35, con 3 maniglie**  
Sac for Tackling  
height 140 or 120 cm.  
diameter 45 or 35 cm.  
with 3 handles



## PISCINA - Swimming Pool



**Art. E1901**  
Cuffia in poliestere  
Polyester cap

pg.46



**Art. E1904**  
Cuffia in Lycra  
Lycra cap



**Art. E1127**  
Cuffia in silicone  
Silicone cap



**Art. E2607**  
Stringinaso con  
cuscinetti in silicone  
Silicone nose-clip



**Art. E2608**  
Tappi auricolari in silicone  
automodellanti - Set da 4 pz.  
Silicone auricular plugs



**Art. E2620**  
Occhialini  
da piscina Junior  
Junior glasses



**Art. E2626**  
Occhialini  
da piscina adulto antifog  
monoscocca morbida  
Senior antifog glasses



**Art. E2618**  
Occhialini da piscina adulto antifog  
monoscocca morbida  
custodia con cerniera  
Senior soft antifog glasses  
case with zip



**Art. E2641**  
Ostacolatore monoblocco  
cm.15x22x7,5



**Art. E2640**  
Tavoletta per piscina bambino  
(sino ad esaurimento)  
Junior board



**Art. E2639**  
Tavoletta per piscina adulto  
professionale cm.40x27  
Senior professional board



**Art. E2650**  
Paio palette palmari forate  
cm.21x16 (misura S, M, L)



**Art. E2660**  
Copriscarpe in PVC  
set da 2000 pezzi - misura unica



**Art. E2637/0**  
Paio manicotti arrotolabili  
doppia valvola (3/6 anni)  
Brackets



**Art. E845**  
**Paracadute per nuoto potenziato**  
Swimming parachute



**Art. E848**  
**Marsupio per nuoto potenziato**  
Swimming pouch



**Art. E851**  
**Elastico per nuoto trattenuto - mt. 12**  
Swimming elastic



**Art. E483**  
**Paio manubri per aquagym**  
cm.30 - diam. cm.14  
Water aerobics dumbbells

pg.46



**Art. E482**  
**Paio polsieri/cavigliere per aquagym**  
mis. cm. 62x11x2  
Water aerobics wrist/ankle supports



**Art. E474**  
**Paio clavette per aquagym**  
Water aerobics clubs



**Art. E484**  
**Cintura per aquagym**  
cm.67x29x4  
Water aerobics belt



**Art. E479/3**  
**Zattera in espanso forata**  
dim. cm.200x100x3  
Pierced mat

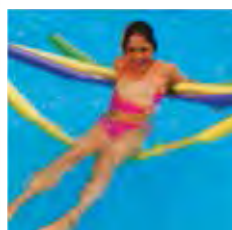

**Art. E470**  
**Cilindro in materiale espanso per aquagym**  
cm. 160 ø cm. 7  
Water aerobics bar



**Art. E480/1**  
**Connettore per cilindro**  
mis. cm.14 - 2 fori  
Bar connector



**Art. AQSA**  
**Step per aquagym impilabile ad incastro**  
cm.70x35x19  
Water aerobics step  
cm.70x35x19

## PALLANUOTO - Waterpolo

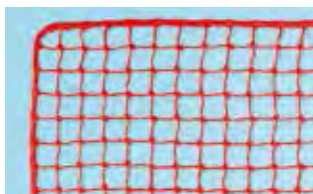
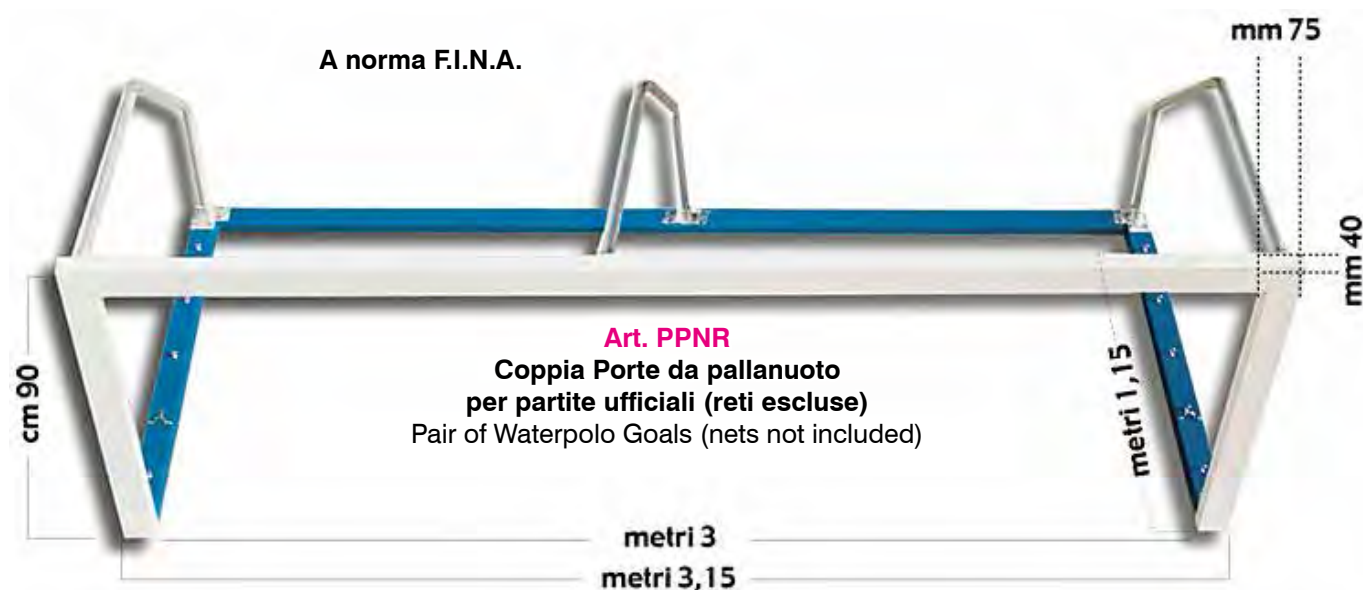

**Art. 175P**  
**Coppia reti per porte pallanuoto**  
Waterpolo Nets

pg.46



**Art. AQPP**  
**Coppia Miniporte da pallanuoto in PVC m. 1,5x0,8 complete di reti**  
Pair of Waterpolo PVC Mini-goals m. 1,5x0,8 nets included



**Art. E80**  
**Pallone pallanuoto Trial in Eva gr. 420 Ø 21 cm.**  
Waterpolo Trial ball in Eva



**Art. E6890**  
**Pallone pallanuoto**  
Waterpolo Ball



**Art. 30415**  
**Set cuffie pallanuoto colore bianco o blu con numero - set 14 pezzi**  
Waterpolo caps with numbers



## HOCKEY



pg.47

**Art. S05128**

**Coppia porte per Hockey su pista  
in acciaio verniciato**

Pair of Hockey Goals in painted steel

**Art. S05122**  
**Coppia porte per Hockey su prato  
in legno e acciaio verniciato**  
Pair of Hockey Goals in wood  
and painted steel



**Art. PUH01**  
**Pallina Unihockey**  
Unihockey ball



**Art. S05134**  
**Set Unihockey composto  
da 6+6 bastoni e 3 palline**

Set Unihockey made of 12 sticks and 3 balls

**Art. H1**

**Coppia RETI per porte da Hockey pista  
(indoor) in polipropilene maglia mm.45  
cm.300x200x100x100**

Pair of Track Hockey Goal nets

**Art. H2**

**Coppia RETI per porte da Hockey  
ghiaccio in polipropilene complete di rete  
di sbarramento, maglia  
mm.20 - cm.193x122x75x120**

Pair of Ice Hockey Goal nets

**Art. H3**

**Coppia RETI per porte da Hockey  
prato in polipropilene complete di rete  
di sbarramento, maglia  
mm.45 - cm.366x214x90x122**

Pair of Field Hockey Goal nets

**Art. H4**

**Coppia RETI per porte da Hockey rotelle in  
polipropilene complete di rete di sbarramento,  
maglia mm.20 - cm.185x122x74x110**

Pair of Roller Hockey Goal nets

## BASEBALL



**Art. TMB01**  
**Mazza Baseball supersoft Trial**  
 lunghezza cm.71 diametro cm.4/5  
 peso gr.460  
 Supersoft Trial baseball bat

pg.48



**New!**

**Art. MBL**  
**Mazza baseball legno Louisville Slugger S3X**  
 Wooden baseball bat



**New!**

**Art. WA360**  
**Guanto Baseball destro Wilson A360 12"**  
 in pelle misura senior  
 Wilson senior baseball glove



**Art. 31683**  
**Palla Baseball**  
 (disponibile fino ad esaurimento scorte)  
 Baseball ball



**New!**

**Art. WA1010S**  
**Palla Baseball Wilson A1010S**  
 Wilson A1010S Baseball ball

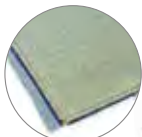

appoggio  
antiscivolo



**Art. P21006**  
**Set basi didattiche**  
 antiscivolo colorate  
 Set of didactic anti-skid  
 bases



imbottitura  
interna

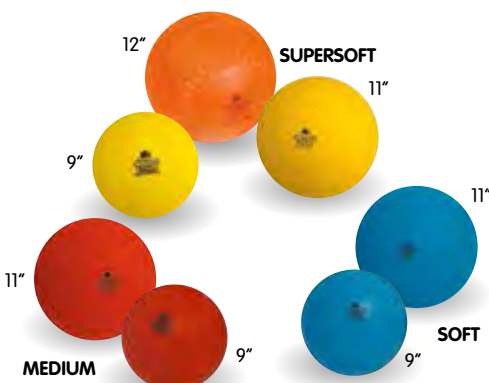

**Art. BSB.8**  
**Set 7 Palle baseball/softball**  
**Trial in gomma super soft**  
 diametri e grammature  
 assortiti  
 Set of Trial baseball/softball  
 balls



**Art. T21063**  
**Batting tee Trial**  
 supersoft  
 altezza regolabile  
 da cm. 65 a cm. 86  
 base diametro cm. 20,5  
 peso Kg. 3  
 Trial Batting tee  
 adjustable height

## ARTI MARZIALI - Martial Arts



**Art. 24772**  
Divisa judo con cintura  
misure dalla 000 (cm.110)  
alla 7 (cm.200)  
Judo strip with belt

pg.56



**Art. 24773**  
Divisa karate con cintura  
misure dalla 00 (cm.120)  
alla 7 (cm.200)  
Karate strip with belt



**Art. 23271**  
Cintura judo/karate 100% cotone  
colori: nero, blu, arancio, marrone, verde, giallo, rosso  
misure dalla 1 alla 7  
Judo/Karate belt



**Art. 23271.B**  
Cintura judo/karate 100% cotone  
bicolore: bianco/giallo, giallo/arancio,  
arancio/verde, verde/blu,  
blu/marrone - misure dalla 1 alla 7  
Bicoloured Judo/Karate belt

pg.55



**Art. F163**  
Tabellone elettronico  
portatile da tavolo  
per Kick-Boxing  
Kick-Boxing portable  
electronic  
Scoreboard



**Art. F162**  
Tabellone elettronico portatile da  
tavolo per Karate  
Karate portable  
electronic  
Scoreboard

**Art. F150**  
Fight Timer da parete  
cm.56x19x4 - kg.1,6  
Fight Timer



## BOXE



**Art. 992030**  
**Sacco Boxe in vinile Kg.30**  
Vinyl boxing bag kg.30



**Art. 992040**  
**Sacco Boxe in vinile Kg.40**  
Vinyl boxing bag kg.40



**Art. 992050**  
**Sacco Boxe in vinile Kg.50**  
Vinyl boxing bag kg.50



**Art. 993003**  
**Gancio Ammortizzatore per sacco boxe**  
Spring for boxing bag

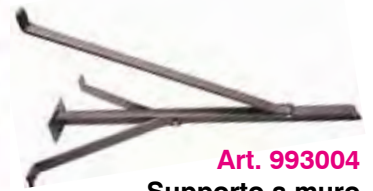

**Art. 993004**  
**Supporto a muro per sacco boxe**  
Iron wall support for boxing bag



**Art. 992840**  
**Sacco Boxe basculante h. cm. 170 zavorrato con sacchi di sabbia (inclusi)**  
Self-straightening boxing bag height cm.170



**Art. 992804**  
**Sacco Boxe con pedana riempibile con acqua o sabbia, altezza regolabile (max cm. 220)**  
Freestanding bag adjustable height

pg.55



**Art. F350**  
**Kit pera su mensola**  
Pear for boxing



**Art. 42233A**  
**Casco Boxe**  
misure S,M,L,XL  
Boxing helmet

pg.55



**Art. 44613A**  
**Set protezioni**  
parastinco +  
parapiede  
misure S,M,L,XL  
Shin/foot protections



**Art. 17211**  
**Coppia Fasce boxe**  
Boxing bandages



**Art. 54613A**  
**Guanti da Sacco in PU**  
taglie S,M,L,XL  
Bag gloves



**Art. 21796**  
**Guanti Fit-Boxe**  
taglie S,M,L,XL  
Fit-Boxing gloves



**Art. 74613A**  
**Guanti MMA in PU**  
taglie S,M,L,XL  
MMA gloves



**Art. 84613A**  
**Guanti Boxe**  
in pelle  
per combattimento  
non omologati  
8/10/12 oz.  
Leather boxing gloves



**Art. GBL10T**  
**Guanti Boxe**  
Leone in pelle  
10 oz.  
Leone Boxing  
gloves

## MATERASSI - TAPPETI - Mats



### Art. B2001/ ... /B2016

**Materassi di caduta realizzati con fodera di rivestimento in PVC antimuffa, antibatterica, ignifuga Cl.2 con imbottitura in gommapiuma di varie densità**  
(vedere listino per le dimensioni)  
Mats of various dimension and thickness

Disponibili anche con fondo antiscivolo  
also available with anti-skid bottom

pg.48

pg.49

### Art. B2033/ ... /B2047

**Fodere di ricambio in PVC antimuffa, antibatteriche, ignifughe Cl.2**  
(vedere listino per le dimensioni)  
Spare covers for mats various dimensions



Particolare Art. B2014/  
B2015/B2016  
(i materassi cm.200x400 sono tagliati a 45° in 2 pezzi tenuti insieme da strisce di velcro)

### Art. B2228/ ... /B2231

**Tappeti Gym Mat dim. cm.200x100 spessore cm.3/4/5/6 ad alta densità in polietilene a cellule chiuse (per uscita attrezzi)**  
High density Gym Mats

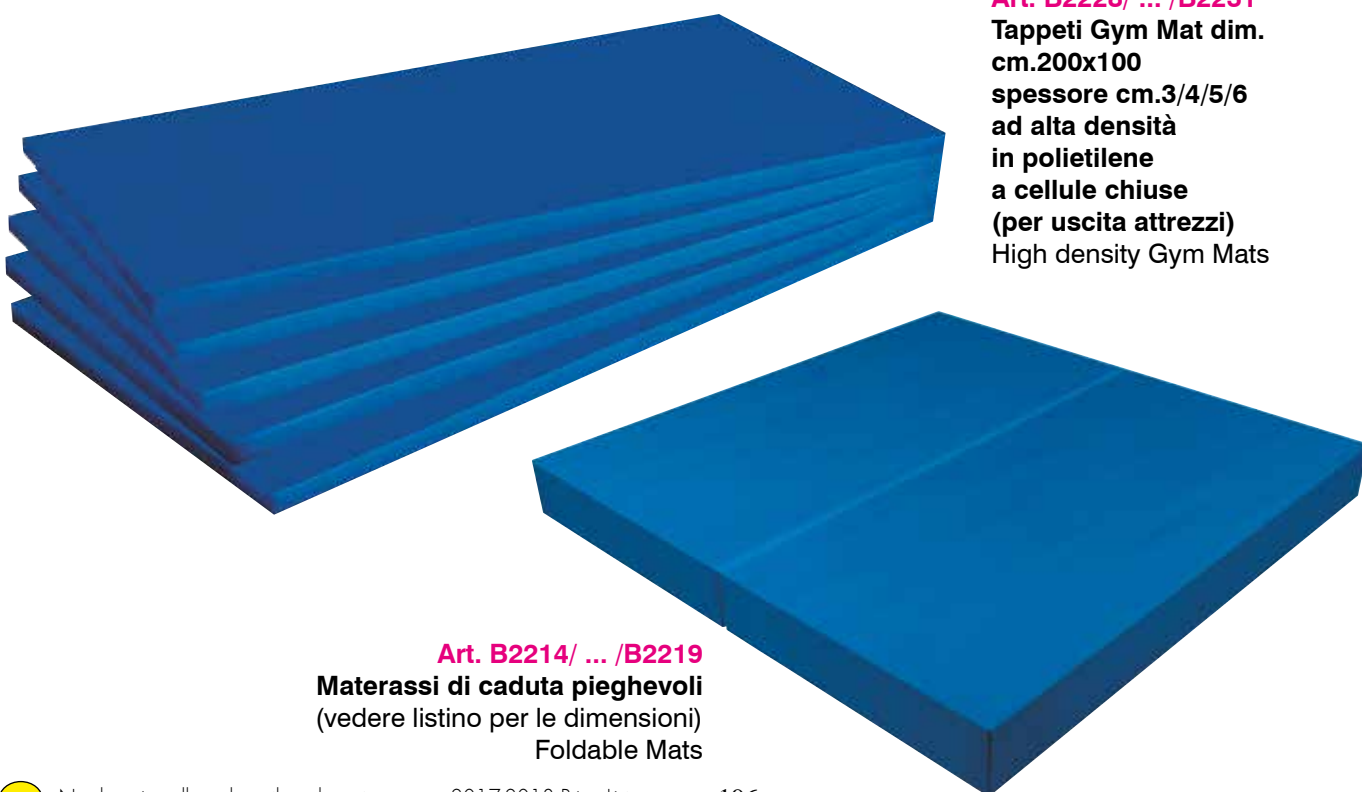

### Art. B2214/ ... /B2219

**Materassi di caduta pieghevoli**  
(vedere listino per le dimensioni)  
Foldable Mats

**Art. S00676**  
**Carrello porta materassi**  
**cm. 200x100**  
**in acciaio verniciato**  
**mobile su ruote**  
Mat Trolley in painted steel size  
200x100 cm. on wheels



pg.49



**Art. S00678**  
**Carrello porta materassi**  
**in verticale cm. 250x105**  
**in acciaio verniciato**  
**mobile su ruote**  
**(elastici inclusi)**  
Vertical mat Trolley in painted  
steel size 250x105 cm.  
on wheels  
(elastics included)



**Art. TEST.M**  
**Tappeto Mat Test cm.100x370**  
**con scala centimetrata da 0 a 300 cm.**  
Mat Test 100x370 cm.

**Per allenamento tuffi portieri ed acrobazie giocatori**  
**For GK dive and players' acrobatic shooting training**

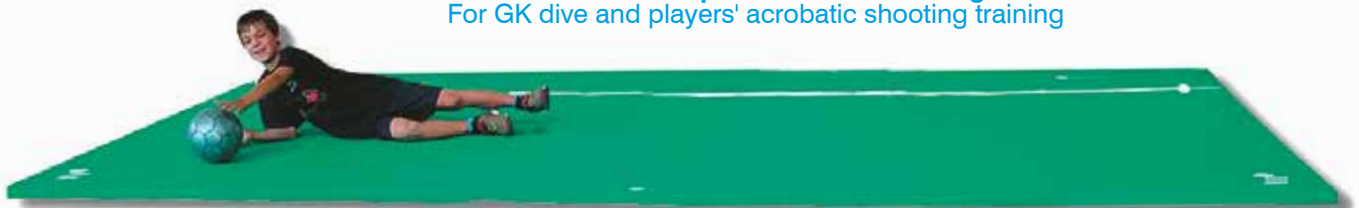

**Art. BGAP13**  
**Tappeto Ammortizzante pieghevole dimensioni cm. 200x450**  
**superficie in vinile monospalmato - fondo antiscivolo, imbottitura densità 40 Kg/mc**  
Foldable soft Mat for goal-keeper and players' safe dives - size 200x450 cm.

pg.48



## PROTEZIONI MURARIE E PER COLONNE - Wall protections



PREVENTIVO SU RICHIESTA  
PRICES ON REQUEST



**Art. B2085 / B2066**

**Protezioni murarie e per colonne in vari spessori sagomate su misura in EVA oppure PE alta densità rivestito in PVC fissaggio tramite occhiellature perimetrali, velcro oppure colla - per interno ed esterno**  
Customized wall and column protections various thickness for indoor and outdoor

pg.48



**New!**

**Art. A10100/A10150/A10200**  
**Protezioni paraspigoli in PVC coestruso non ignifugo spessore cm. 1 larghezza cm. 5+5 in vari colori lunghezza cm. 100-150-200**  
PVC Edge Protections 1 cm. thick width 5+5 cm. length 100-150-200 cm.

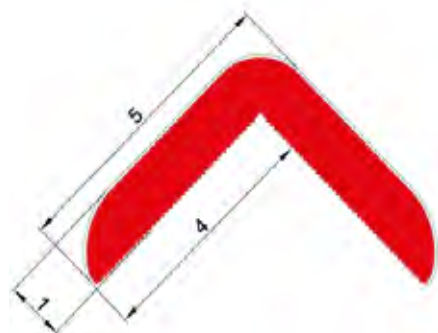



## TATAMI

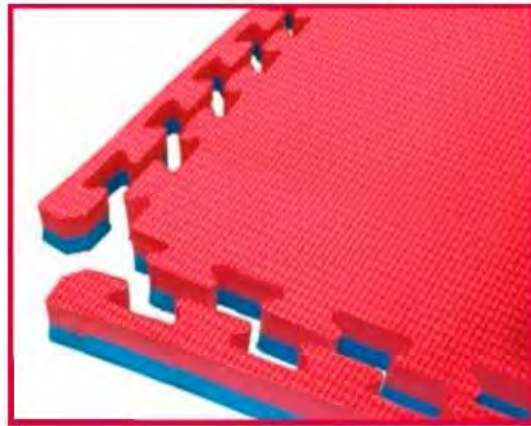

### Art. MAT02 / MAT04

**TATAMI ad incastro cm.100x100x2/cm.100x100x4 rosso/blu con 4 bordi  
superficie lavabile, antiscivolo, antifunghi, antibatterica, testato anallergico, Certificato EN71  
Tatami soft flooring 100x100x2 cm./100x100x4 cm.**

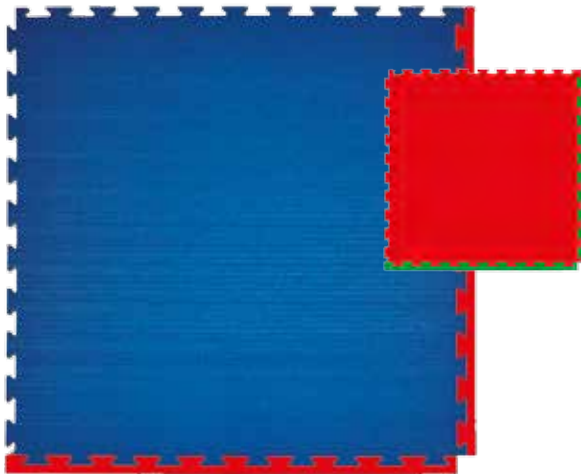

### Art. TX-K20

**TATAMI Karate K20  
cm. 100x100x2 ad incastro, reversibile  
in polietilene espanso reticolato  
incluso bordo protettivo perimetrale  
colori: verde/rosso, rosso/blu  
TATAMI K20 100x100x2 cm.  
reversible, perimetric frame included  
colors: red/green, red/blue**

pg.56

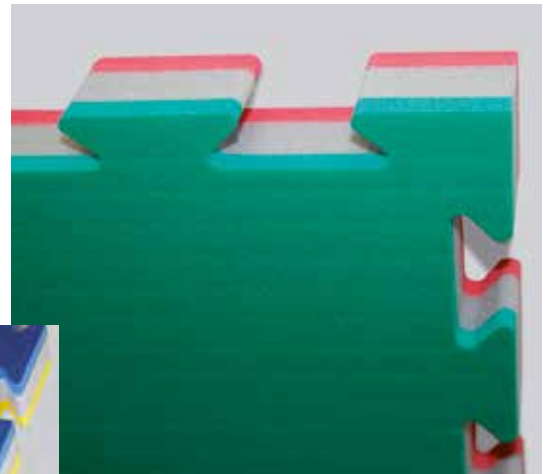

### Art. TX-J40

**TATAMI Judo J40  
cm. 100x100x4 ad incastro, reversibile  
in polietilene espanso reticolato  
incluso bordo protettivo perimetrale  
colori: verde/bianco/rosso, giallo/bianco/blu  
TATAMI J40 100x100x4 cm. 3 colors, reversible,  
perimetric frame included  
colors: red/green/white, yellow/white/blue**



### Art. TX-2010

**TATAMI tradizionale  
cm. 200x100x4 in PU  
densità 230 Kg/mc  
rivestito in PVC  
con fondo antiscivolo  
colori: blu, verde, rosso, giallo  
TATAMI 200x100x4 cm.  
in PU density 230 Kg/mc  
cover with anti-skid PVC stratum  
colors: blue, green, red, yellow**

## GINNASTICA - Gymnastic



**Art. S00352**

**Armadio porta attrezzi con vano portavalori  
a 4 ripiani in lamiera  
dimensioni cm. 100x45x200h  
Equipment locker with safe-deposit box**

● pg.50



**Art. S00354**

**Armadio porta attrezzi a 4 ripiani  
in lamiera dimensioni cm. 100x45x200h  
Equipment locker**



**Art. S00356**

**Armadio porta attrezzi  
in lamiera dimensioni  
cm. 120x45x200h  
a 4 ripiani  
e porte scorrevoli  
Equipment locker with  
sliding doors**

● pg.50

**Art. S00362**

**Mobile porta attrezzi su ruote  
Equipment trolley on wheels**

● pg.24

**Art. V1048  
Armadio in rete con  
maniglioni e ruote  
telaio in acciaio  
dimensioni  
cm. 150x75x160h  
Equipment locker  
on wheels**





**Art. S00304**  
**Coppia ceppi Baumann in legno**  
Pair of Baumann blocks in wood



**Art. S00302**  
**Coppia appoggi Baumann in legno**  
Pair of Baumann supports in wood

pg.50

**Art. S00002**  
**Coppia anelli in legno lamellare**  
Pair of wood rings



pg.49

**Art. S00018**  
**Confezione da 8 pani magnesio gr. 55**  
Chalk blocks



**Art.S00512**  
**Mensola porta clavette**  
Club wall holder



**Art. E8000**  
**Paio scarpette in pelle per ginnastica ritmica**  
taglie da 26 a 46  
Pair of shoes for rhythmic gym  
color black or white

**Art. P00510/S00502/S00506**  
**Coppia clavette in nylon, in legno a collo lungo e collo corto**  
Wooden and plastic clubs



**Art. CS5**  
**Corda salto per ritmica m. 3**  
Jumping rope



**Art. P01210**  
**Nastro per ginnastica ritmica m. 6**  
Rhythmic gym streamer



**Art. CS7**  
**Corda salto per ritmica m. 3 piombata**  
Weighted jumping rope



**Art. S01482**  
**Tamburello completo di batacchio**  
Rhythmic gym drum



**Art. S01624**  
**Specchio quadrettato con cornice in legno da fissare a parete**  
misure cm.200x100  
Wall mirror with wooden frame

pg.51



**Art. S01606**  
**Supporto per sbarra regolabile da fissare a parete**  
 Support for bar to be fixed on the wall

**Art. S01602**  
**Sbarra per danza in legno (pezzo unico fino a 4 metri)**  
 Wooden bar



**Art. 1156TE**

**Supporto per sbarra regolabile da cm. 78 a cm. 140 in acciaio con base autoportante economica**  
 Cheap freestanding support for bar



**Art. S01608**  
**Supporto per sbarra regolabile da fissare a terra**  
 Support for bar to be fixed on the floor

pg.51



pg.50

**Art. S00772/S00774**  
**Fune per salita lunghezza m. 5/m. 6**  
 Climbing Rope length 5 m./6 m.

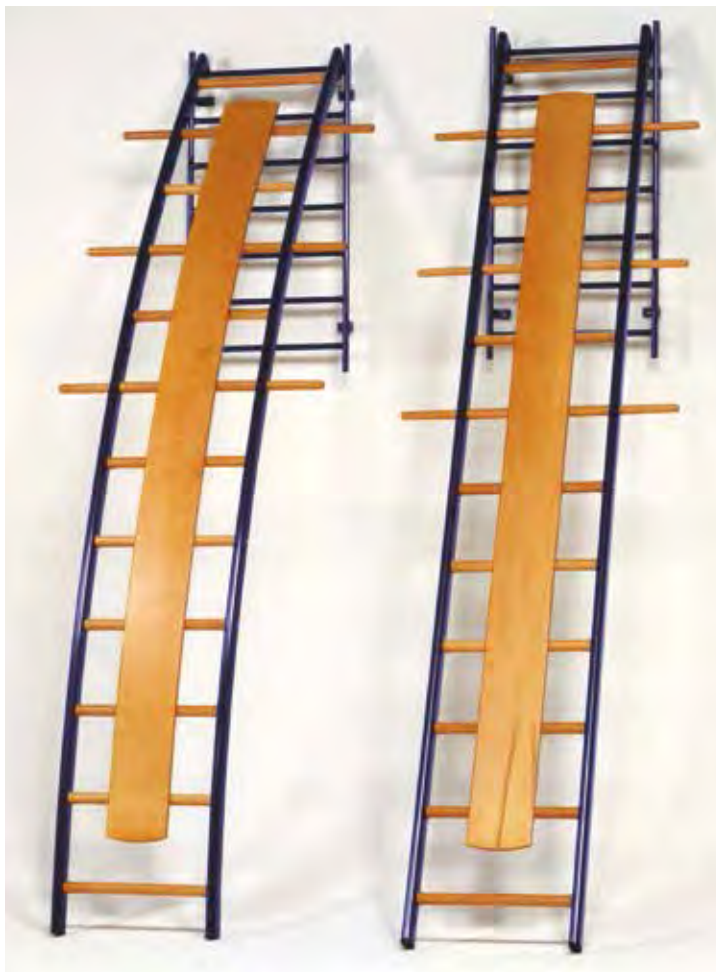

**Art. S01052 / S01054 / S01060 / S01062**  
**Scale ortopediche dritte o curve, a parete o trasportabili**  
 Orthopaedic ladders

pg.50

pg.51



**Art. S00754 / S00756**  
**Palchi di salita Climbing apparatus**



pg.50

**Art. S00056 / S00058 / S00052 / S00054**  
**Assi di equilibrio ad altezza fissa e graduabile**  
Balance beams adjustable and fixed height



pg.51

**Art. S00060 / S00064**  
**Trave di equilibrio in alluminio rivestito lungh. mt.5 ad altezza regolabile (a norme F.I.G.) oppure ad altezza fissa**  
Balance beam 5 meters adjustable height 50-120 cm. or fixed height



**Art. S00204/S00206/S00208/S00210**  
**Pedane elastiche con piano di battuta in legno, ricoperto in gomma, ricoperto in moquette o a doppio molleggio**  
Springboards



**Art. S00104**  
**Cavallo per volteggio senza maniglie rivestito in cuoio sintetico altezza regolabile**  
Vaulting buck adjustable height

pg.50



**Art. V1168**  
**Cavallina regolamentare rivestita in cuoio sintetico altezza regolabile da cm. 90 a cm.130**  
Vaulting buck adjustable height



pg.51

**Art. S00218/S00220**  
**Tappeto arrotolabile per pedana corpo libero in poliuretano e moquette, rotolo da m. 15/25 altezza cm. 100/200**  
Gymnastic moquette floor, roll m.15/25 long 100/200 cm. height



pg.14

**Art. S00914/S00918/S00920**  
**Panche svedesi**  
Swedish benches



**Art. S00252**  
**Sbarra orizzontale**  
**per volteggi regolabile in**  
**altezza, fissaggio**  
**a terra con tiranti**  
Vaulting bar adjustable height



**Art. S00160**  
**Parallela Scolastica a losanga**  
**ad altezza fissa, staggi in legno lamellare**  
Scholastic parallels fixed height

pg.51



**Art. S00156**  
**Parallela Asimmetrica Femminile in acciaio verniciato**  
**su basamento pesante, montanti graduabili,**  
**staggi in legno lamellare regolabili in altezza e larghezza**  
Asymmetrical bars adjustable height



**Art.S00152**  
**Parallela Maschile in acciaio verniciato**  
**su basamento pesante, montanti graduabili,**  
**staggi in legno lamellare**  
**regolabili in altezza e larghezza**  
Parallels bars adjustable height

## ATLETICA - Track & Field



pg.52



pg.51



pg.51



Art. F601  
Ostacolo per Atletica in ferro zincato graduabile cm. 50-60-76,2  
Adjustable height hurdle in galvanized steel



pg.52



Art. S02072  
Ostacolo per Atletica in alluminio anodizzato graduabile cm. 76,2-84-91,4-100-106,7 omologato I.A.A.F.  
Adjustable height hurdle in anodized aluminium according to I.A.A.F. standards





**Art. S02552**  
Coppia ritti salto  
in alto  
scolastici altezza  
cm.200  
Scholastic High Jump  
height 200 cm.



**Art. S02554**  
Coppia ritti salto in alto  
scolastici  
in acciaio zincato  
altezza cm.230  
Scholastic High Jump  
height 230 cm.



**Art. S02556**  
Coppia ritti salto in alto  
in acciaio zincato  
periscopici h. cm.250  
High Jump height 250 cm.

pg.54



**Art. S02558**  
Coppia ritti salto in alto  
in acciaio zincato  
periscopici  
da competizione  
h. cm.260  
Competition High Jump  
height 260 cm.



**Art. S02584**  
Piattaforma zincata di sostegno  
e sollevamento area di caduta  
Galvanized steel support platform  
for landing area

pg.54

pg.55

**Art. B2080/B2081**  
Zone di caduta  
salto in alto  
High Jump landing mats



**Art. S02566**  
Asta segnalimite in PTE  
per salto in alto  
High Jump crossbar  
with soft PTE cylinders



**Art. PVS-CPTA**  
Coppia ritti per salto con l'asta  
in alluminio  
graduabili fino a cm. 650  
Pair of aluminium pole vault stands

**Art. B2077/B2078**  
Zone di caduta salto con l'asta  
Pole vault landing mats



**Art. S02568 / S02570**  
Asta segnalimite  
per salto in alto m. 4  
in alluminio o vetroresina  
High Jump  
aluminium or fiberglass  
crossbar





**Art. TT09/ ... /VT15**  
**Palle lancio**  
**in gomma Trial,**  
**varie grammature**  
 Trial rubber throwing balls



**Art. VDL5/ ... /VDL72**  
**Palle getto anelastiche**  
**in gomma Trial**  
**per indoor**  
**varie grammature**  
 Trial shot balls  
 in rubber for indoor



**Art. S02486/ ... /S02496**  
**Palle getto in metallo verniciato**  
**tarate, varie grammature**  
 Metal shot balls



**Art. S02510**  
**Pedana per lancio del peso**  
**in acciaio zincato**  
 Galvanized steel shot put throwing circle



pg.53

pg.54

**Art. S02512**  
**Fermapiede getto del peso**  
**in legno massiccio**  
 Shot put toe board in wood

**Art. STB-F100**  
**Fermapiede getto del peso**  
**in vetroresina - I.A.A.F.**  
 Shot put toe board in fiberglass - I.A.A.F.



pg.52

**Art. VVS-100**  
**Podio vincitori in metallo verniciato,**  
**piano in laminato - impilabile**  
 Painted Iron Podium



pg.54

**Art. LM0.5/ ... /LM5**  
**Martelli sicuri supersoft**  
**in gomma Trial**  
**varie grammature**  
 Supersoft Trial hammers



pg.54

**Art. P15020**  
**Pedana Lancio in neoprene espanso**  
**per allenamento lancio disco, giavellotto, peso,**  
**martello e salto in lungo**  
 Training toe board

**Art. PM2/ ... /PM10**  
**Martelli in acciaio da allenamento Polanik**  
 Steel hammers



**Art. DSK1/ ... /DSK2**  
**Dischi in gomma Trial varie grammature**  
 Discus in rubber Trial



**Dischi Jet speciali per avviamento al lancio con peso distribuito sulla parte esterna per favorire la penetrazione nell'aria**  
 Special Jet discus with weight distributed mainly on the external perimeter in order to increase air penetration

**Art. JET03/JET05/JET1**  
**Dischi Jet in gomma**  
 Trial Kg. 0,3/0,5/1  
 Jet discus in rubber Trial

pg.52



**Art. DT0.4/ ... /DT1**  
**Dischi Trial a 3 impugnature in gomma approvati I.A.A.F. per attività scolastica**  
 Trial discus approved by I.A.A.F. for school training

**Art. W4T/ ... /W10T**  
**Giavellotti Polanik in lega leggera puntale acciaio varie grammature**  
 Polanik Javelins in light alloy with steel edge in various weights



**Art. TPD075/ ... /TPD3**  
**Dischi in plastica bordati in acciaio Polanik**  
 Discus in plastic-steel



**Art. CPD1/ ... /CPD2**  
**Dischi in nylon bordati in acciaio Polanik - omologati I.A.A.F.**  
 Discus in nylon-steel

pg.53



**Art. TRTJ**  
**Turbo Jav per avviamento al lancio**  
 Turbo Jav for throwing introduction



**Art. P15262**  
**Junior Jav in polietilene espanso**  
 cm. 88  
 grammi 50

**Art. JAL-C400/ ... / JAL-C800**  
**Giavellotti Vinex in lega leggera puntale in acciaio varie grammature**  
 Vinex Javelins in light alloy with steel edge in various weights



**Art. VMH**  
**Vortex per avviamento al lancio del giavellotto e per football americano**  
 Vortex for throwing introduction

pg.53



**Art. VMH.J**  
**Mini Vortex gr. 40 lunghezza cm. 17**

## PILATES



**Art. EVA.P**  
**Mattoncino pilates in eva**  
 cm.22,5x14,5x7,5h  
 Block for pilates



**Art. MPS50**  
**Mattoncino**  
**pilates gonfiabile**  
 Trial soft gr. 500  
 cm.11,3x24x5,5h  
 Inflatable block for pilates



**Art. MPS30**  
**Mattoncino**  
**pilates gonfiabile**  
 Trial soft gr. 300  
 cm.12x24x3,5h  
 Inflatable block for pilates

pg.56 pg.57

**New!**



**Art. BA4**  
**Palla tender per pilates**  
 ø cm.20 - gr. 180  
**super soffice e sicura**  
 Trial rubber tender ball  
 for pilates



**Art. AHF-065/AHF-066**  
**Sfera tonificante**  
 verde kg.1 / viola kg.1,5  
 Toning balls



**Art. AHF-045**  
**Palla per yoga**  
 ø cm.25  
 Yoga ball



**Art. AHF-001**  
**Coppia sfere per massaggi**  
 verde ø cm.7,5  
 viola ø cm.9  
 Massage balls



**Art. TR38**  
 Toning ring



**Art. B55 / B75**  
**Relax Ball Trial ø cm.5,5 / 7,5**  
 Relax Ball

pg.21



**Art. AHF-020**  
 Power grip ball

**New!**



**Art. FY9512**  
**Fitball roller**  
**gonfiabile**  
 diametro cm.18  
 Fitball roller inflatable



**Art. 995025**  
**Cilindro pieno**  
**Foam roll**  
 lunghezza cm. 90  
 ø cm.15  
 Foam roll not inflatable



**Art. AHF-044**  
**Rullo massaggiante**  
 lunghezza cm.33  
 ø cm.14  
 Massaging roll



pg.23

**Art. TBSA/TBSB**  
**Palla Boa autobilanciante in gomma** Trial  
 oscilla ma torna al suo posto senza rotolare,  
 stabile, ideale per correggere la postura,  
 monocolore per adulti/bicolore per bambini  
 Trial rubber Boa Ball swings but comes back  
 to its original position - very good for postural  
 therapy for adults and children

## PALLAPUGNO - BOCCE - TAMBURELLI



**Art. BA1**

**Air Ball Trial Ø cm. 12 gr. 100**  
morbida e rimbalzante  
(ideale anche per pallapugno)  
Trial Air Ball

**New!**



**Art. M05010**

**Pallapugno FIPAP**  
diametro cm. 14  
FIPAP pallapugno



**Art. M506**

**Guanto da gioco per pallapugno**  
Pallapugno glove



**Art. ST14**

**Palla Canguro Ø cm. 45**  
Trial Cangaroo Ball

 pg.56

 pg.57



**Art. ST15**

**Palla Canguro Ø cm. 55**  
Trial Cangaroo Ball



**Art. ST16**

**Palla Canguro Ø cm. 65**  
Trial Cangaroo Ball



**Art. ASKB**

**Set 8 bocce in legno laccato**  
diametro mm. 100  
con pallino diametro mm. 40  
Set 8 wooden bowls

**Art. BTST12**  
**Set 6+6 bocce supersoft**  
con pallino e borsa  
Set of 12 supersoft  
bowls with bag



**Art. P18110**

**Tamburello indoor**  
diametro cm. 26  
(fino a 13 anni)  
omologato FIPT  
FIPT indoor  
tamburello Ø cm. 26



**Art. P18112**

**Pallina per tamburello**  
depressurizzata  
indoor diametro cm. 6,5  
grammi 40  
Tamburello indoor depressurized ball



**Art. P18111**

**Tamburello indoor**  
diametro cm. 28  
omologato FIPT  
FIPT indoor tamburello  
Ø cm. 28



**Art. S00552 / S00556**  
**Fune per tiro alla fune**  
lunghezza m. 15 / m. 25  
con indicazioni colorate  
Rope for tug of war  
length 15 / 25 meters



**Art. I-059**

**Set 10 mattoncini dritti**  
**cm. 25x16x13h**  
 Set of 10 straight bricks

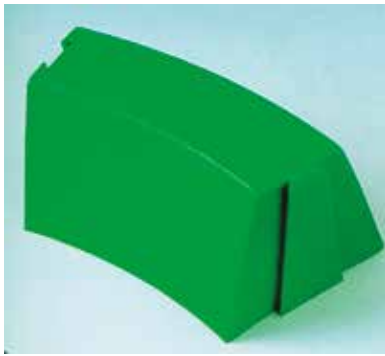

**Art. I-060**

**Set 10 mattoncini curvi**  
**cm. 22x16x13h**  
 Set of 10 curved bricks



**Art. I-098**

**Blocco percorso**  
**cm. 30x15x10h**  
 Block for route



**Art. PCAD**

**Paracadute Ø cm. 300**  
 Parachute

pg.57



**Art. I-061**

**Percorso equilibrio composto da**  
**5 assi + 6 mattoncini + 24 ventose**  
 Balance route

pg.56



**Art. S00794**

pg.51

**Pannello per arrampicata in legno**  
**agganciabile a spalliera o quadro**  
**svedese**  
 Climbing board



**PALLA**  
**AVVELENATA**  
**Dodgeball**



**Art. TDB16**

**Palla per Dodgeball diametro cm. 16**  
**peso grammi 210 colore arancio fluo**  
 Dodgeball Ø cm. 16

**Art. TDB20**

**Palla per Dodgeball diametro cm. 20**  
**peso grammi 230 colore giallo fluo**  
 Dodgeball Ø cm. 20



## SKATEBOARD - PATTINI - MONOPATTINI - FRISBEE



**Art. F4AK2401** Skateboard Junior cm.61



**Art. SKM3101** Skateboard Senior cm.77,5



**Art. F4-400**  
Casco Skate  
taglie S, M, L  
Skate helmet

pg.56



**Art. 681171**  
Set 3 protezioni Junior  
**Art. 132171**  
Set 3 protezioni Senior  
(misura S, M, L)  
Junior and Senior protections



**Art. F4JR026**  
Pattino in line  
allungabile Junior  
Taglie: 30/33 - 34/37 - 38/41  
In line skate adjustable size



**Art. ML32B**  
Monopattino  
pieghevole,  
ruote da 125 mm.  
peso massimo  
utilizzatore 50 kg.  
Scooter



**Art. ML001**  
Monopattino  
pieghevole,  
ruote da 200 mm.  
peso massimo  
utilizzatore 100 kg.  
Scooter



**New!**

**Art. FRPPR**  
Frisbee  
diametro cm. 27,5 - gr.160  
Frisbee

## INDICE ALFABETICO

Archi di precisione.....	pag. 47
Arredi spogliatoio e infermeria.....	pag. 148-153
Atletica.....	pag. 205-208
Badminton.....	pag. 186
Bande elastiche.....	pag. 75-78
Bandierine e accessori per arbitro.....	pag. 104-107
Barriere filtranti.....	pag. 24
Baseball.....	pag. 192
Basket.....	pag. 157-163
Beach Soccer.....	pag. 155
Beach Volley.....	pag. 172-173
Birilli.....	pag. 30-32
Borracce.....	pag. 101
Borse.....	pag. 120-121
Boxe, Arti Marziali.....	pag. 193-195
Calze.....	pag. 89
Carrelli Traccialinee.....	pag. 142-143
Casacche.....	pag. 88
Cerchi, Corde, Bastoni.....	pag. 70
Ceste Portapalloni.....	pag. 122
Delimitatori.....	pag. 28-29
Deviatore di traiettoria, Ball Playning.....	pag. 58
Fasce Capitano.....	pag. 93
Fitness Equipment.....	pag. 80-87
Forche.....	pag. 48-49
Ghiaccio, Tape, Creme, Oli.....	pag. 102-103
Ginnastica.....	pag. 200-204
Guanti Portiere.....	pag. 93
Hockey.....	pag. 191
Impianti Multifunzione.....	pag. 171
Kit Calcio Tennis.....	pag. 43-46
Kit tecnico Scuola Calcio.....	pag. 79
Lavagne Tattiche.....	pag. 98-100
Materassi.....	pag. 196-197
Materassini.....	pag. 97
Minivolley.....	pag. 170
Muri e Telai con rete.....	pag. 50-57;59
Numeri Termosaldabili.....	pag. 91
Ostacoli ad altezza fissa e regolabile.....	pag. 33-42
Paletti.....	pag. 25-27
Pallamano.....	pag. 176
Palle Mediche, Ritmiche e Psicomotorie.....	pag. 116-119
Palloni in pelle ed in gomma.....	pag. 112-115
Panchine Allenatori.....	pag. 135-141
Pantaloncini.....	pag. 89
Parastinchi.....	pag. 92
Pilates, Didattica Scolastica, Pattini e Skateboard.....	pag. 209-212
Piscina, Pallanuoto.....	pag. 188-190
Pompe, Compressori, Cronometri e Rotelle Metriche.....	pag. 108-109
Porte regolamentari, ridotte, miniporte, porte bifrontali.....	pag. 123-131
Protezioni Murarie.....	pag. 198
Protezioni Personali.....	pag. 174-175
Reti di Protezione.....	pag. 134
Reti regolamentari e ridotte.....	pag. 132-133
Rugby.....	pag. 187
Sagome.....	pag. 12-23
Scalette e attrezzi speciali.....	pag. 68-69;71-74
Scocche per tribune e Tribune modulari per interno ed esterno.....	pag. 145-147
Segnalatori elettronici e manuali per cambio giocatori, Segnapunti.....	pag. 110-111
Strutture instabili e Tavole Propriocettive, Plinti.....	pag. 60-66
Tabelloni elettronici segnapunti.....	pag. 177-179
Tacchetti e accessori per scarpe, Lavascarpe.....	pag. 94-96
Tavoli calcetto.....	pag. 156
Tennis Tavolo.....	pag. 183-185
Tennis, Beach Tennis.....	pag. 180-182
Trampolini.....	pag. 67
Tunnel uscita spogliatoi.....	pag. 154
Vernice segnacampo.....	pag. 144
Volley.....	pag. 164-169



# BARRET®

ATTREZZATURE PER L'ALLENAMENTO DEI CAMPIONI  
TRAINING TOOLS FOR CHAMPIONS



## **BARRET s.r.l.**

Via Marie Curie, 6/8  
Zona Ind.le S. Pietro in Palazzi  
57023 Cecina (LI) - Italy  
telefono (+39) 0586 661215  
fax (+39) 0586 662417  
info@barretsport.com  
www.barretsport.com

